

Air Conditioning Technical Data

RXYQ-U



- > RXYQ8U7Y1B
- > RXYQ10U7Y1B
- > RXYQ12U7Y1B
- > RXYQ14U7Y1B
- > RXYQ16U7Y1B
- > RXYQ18U7Y1B

- > RXYQ20U7Y1B

TABLE OF CONTENTS

RXYQ-U

1	Features	2
2	Specifications	3
	Technical Specifications	3
	Electrical Specifications	6
	Technical Specifications	7
	Technical Specifications	10
	Electrical Specifications	13
	Electrical Specifications	13
3	Options	15
4	Combination table	16
5	Capacity tables	19
	Capacity Table Legend	19
	Capacity Correction Factor	20
6	Dimensional drawings	33
7	Centre of gravity	34
8	Piping diagrams	35
9	Wiring diagrams	36
	Wiring Diagrams - Three Phase	36
10	External connection diagrams	40
11	Sound data	42
	Sound Power Spectrum	42
	Sound Pressure Spectrum	46
	Sound Pressure Spectrum Quiet Mode	50
12	Installation	55
	Installation Method	55
	Fixation and Foundation of Units	56
	Refrigerant Pipe Selection	57
13	Operation range	60
14	Appropriate Indoors	61

1 Features

Daikin's solution for comfort & low energy consumption

- Covers all thermal needs of a building via a single point of contact: accurate temperature control, ventilation, hot water, air handling units and Biddle air curtains
- Wide range of indoor units: possibility to combine VRV with stylish indoor units (Daikin Emura, Nexura, ...)
- Incorporates VRV IV standards & technologies: Variable Refrigerant Temperature, VRV configurator, 7 segment display and full inverter compressors, 4-side heat exchanger, refrigerant cooled PCB, new DC fan motor, ...
- Customize your VRV for best seasonal efficiency & comfort with the weather dependant Variable Refrigerant Temperature function. Increased seasonal efficiency with up to 28%. No more cold draft by supply of high outblow temperatures
- VRV configurator software for the fastest and most accurate commissioning, configuration and customisation
- Outdoor unit display for quick on-site settings and easy read out of errors together with the indication of service parameters for checking basic functions.
- Free combination of outdoor units to meet installation space or efficiency requirements
- Fits any building as also indoor installation is possible as a result of high external static pressure of up to 78.4 Pa. Indoor installation leads to less piping length, lower installation costs, increased efficiency and better visual aesthetics
- Simplified installation & guaranteed optimal efficiency with automatic charging & testing
- Easy compliance with F-gas regulation thanks to automated refrigerant containment check
- Wide piping flexibility: 30m indoor height difference, maximum piping length: 190m, total piping length: 1,000m
- The ability to control each conditioned zone individually keeps VRV system running costs to an absolute minimum
- Spread your installation cost by phased installation
- Keep your system in top condition via the Daikin Cloud Service: 24/7 monitoring for maximum efficiency, extended lifetime and immediate service support thanks to failure prediction
- Available as heating only by irreversible field setting



Inverter

2 Specifications

2-1 Technical Specifications				RXYQ8U	RXYQ10U	RXYQ12U	RXYQ14U	RXYQ16U	RXYQ18U	RXYQ20U
Recommended combination				4 x FXFQ50AV EB	4 x FXFQ63AV EB	6 x FXFQ50AV EB	1 x FXFQ50AV EB + 5 x FXFQ63AV EB	4 x FXFQ63AV EB + 2 x FXFQ80AV EB	3 x FXFQ50AV EB + 5 x FXFQ63AV EB	2 x FXFQ50AV EB + 6 x FXFQ63AV EB
Recommended combination 2				4 x FXSQ50A2 VEB	4 x FXSQ63A2 VEB	6 x FXSQ50A2 VEB	1 x FXSQ50A2 VEB + 5 x FXSQ63A2 VEB	4 x FXSQ63A2 VEB + 2 x FXSQ80A2 VEB	3 x FXSQ50A2 VEB + 5 x FXSQ63A2 VEB	2 x FXSQ50A2 VEB + 6 x FXSQ63A2 VEB
Recommended combination 3				4 x FXMQ50P7 VEB	4 x FXMQ63P7 VEB	6 x FXMQ50P7 VEB	1 x FXMQ50P7 VEB + 5 x FXMQ63P7 VEB	4 x FXMQ63P7 VEB + 2 x FXMQ80P7 VEB	3 x FXMQ50P7 VEB + 5 x FXMQ63P7 VEB	2 x FXMQ50P7 VEB + 6 x FXMQ63P7 VEB
Cooling capacity	Prated,c		kW	22.4 (1)	28.0 (1)	33.5 (1)	40.0 (1)	45.0 (1)	50.4 (1)	52.0 (1)
Heating capacity	Prated,h		kW	13.7	16.0	18.4	20.6	23.2	27.9	31.0
	Max.	6°CWB	kW	25.0 (2)	31.5 (2)	37.5 (2)	45.0 (2)	50.0 (2)	56.5 (2)	63.0 (2)
SEER				7.6	6.8	6.3		6.0		5.9
SEER recommended combination 2				6.9	6.8	5.9	6.3	5.9	6.0	5.9
SEER recommended combination 3				7.5	6.8	6.2		5.8	6.0	5.9
SCOP				4.3		4.1	4.0		4.2	4.0
SCOP recommended combination 2				4.2	4.3	4.1	4.0	4.1	4.2	4.0
SCOP recommended combination 3				4.2	4.1		4.0		4.1	3.9
ηs,c			%	302.4	267.6	247.8	250.7	236.5	238.3	233.7
ηs,c recommended combination 2				273.6	270.5	233.5	250.0	234.2	236.8	233.9
ηs,c recommended combination 3				295.2	267.1	246.3	246.7	230.4	238.2	233.1
ηs,h			%	167.9	168.2	161.4	155.4	157.8	163.1	156.6
ηs,h recommended combination 2				165.4	170.6	161.3	157.2	159.5	164.8	158.2
ηs,h recommended combination 3				165.6	162.0	160.6	155.7	156.8	159.6	153.4
Capacity range			HP	8	10	12	14	16	18	20
Maximum number of connectable indoor units				64 (3)						
Indoor index connection	Min.			100.0	125.0	150.0	175.0	200.0	225.0	250.0
	Max.			260.0	325.0	390.0	455.0	520.0	585.0	650.0
Dimensions	Unit	Height	mm	1,685						
		Width	mm	930			1,240			
		Depth	mm	765						
	Packed unit	Height	mm	1,820						
		Width	mm	995			1,305			
		Depth	mm	860						
Weight	Unit		kg	198			275		308	
	Packed unit		kg	211			291		324	
Packing	Material			Carton						
	Weight			kg	1.8			2.2		
Packing 2	Material			Wood						
	Weight			kg	11.0			14.0		
Packing 3	Material			Plastic						
	Weight			kg	0.5			0.6		
Capacity control	Method			Inverter controlled						
Casing	Colour			Daikin White						
	Material			Painted galvanized steel plate						
Heat exchanger	Type			Cross fin coil						
	Indoor side			Air						
	Outdoor side			Air						
	Air flow rate	Cooling	Rated	m³/h	9,720	10,500	11,100	13,380	15,600	15,060
Heating		Rated	m³/h	9,720	10,500	11,100	13,380	15,600	15,060	15,660
Compressor	Quantity			1			2			
	Type			Hermetically sealed scroll compressor						
	Crankcase heater			W	33					

2 Specifications

2-1 Technical Specifications				RXYQ8U	RXYQ10U	RXYQ12U	RXYQ14U	RXYQ16U	RXYQ18U	RXYQ20U	
Fan	Quantity			1			2				
	External static pressure	Max.	Pa	78							
Fan motor	Quantity			1			2				
	Type			DC motor							
	Output		W	550			750				
Sound power level	Cooling	Nom.	dBA	78.0 (4)	79.1 (4)	83.4 (4)	80.9 (4)	85.6 (4)	83.8 (4)	87.9 (4)	
	Heating	Nom.	dBA	62.7 (4)	64.8 (4)	64.9 (4)	68.3 (4)	68.6 (4)	66.3 (4)	67.0 (4)	
Sound pressure level	Cooling	Nom.	dBA	57.0 (5)		61.0 (5)	60.0 (5)	63.0 (5)	62.0 (5)	65.0 (5)	
Operation range	Cooling	Min.~Max.	°CDB	-5.0~43.0							
	Heating	Min.~Max.	°CWB	-20.0~15.5							
Refrigerant	Type			R-410A							
	GWP			2,087.5							
	Charge		TCO _{2eq}	12.3	12.5	13.2	21.5	23.6	24.4	24.6	
			kg	5.9	6.0	6.3	10.3	11.3	11.7	11.8	
Refrigerant oil	Type			Synthetic (ether) oil FVC68D							
Piping connections	Liquid	Type		Braze connection							
		OD	mm	9,52		12,7		15,9			
	Gas	Type		Braze connection							
		OD	mm	19.1	22.2	28.6					
Total piping length	System	Actual	m	1,000 (6)							
Defrost method				Reversed cycle							
Safety devices	Item	01		High pressure switch							
		02		Fan driver overload protector							
		03		Inverter overload protector							
		04		PC board fuse							
		05		Leakage current detector							
PED	Category			Category II							
	Most critical part	Name		Accumulator							
		Ps*V	Bar*l	325			415		493		
Space cooling	A Condition (35°C - 27/19)	EERd		3.0	2.3	2.4	2.6	2.1	1.9		
		Pdc	kW	22.4	28.0	33.5	40.0	45.0	50.4	52.0	
	B Condition (30°C - 27/19)	EERd		5.2	4.7	4.3	4.1	3.9	3.8	3.7	
		Pdc	kW	16.5	20.6	24.7	29.5	33.2	37.1	38.3	
	C Condition (25°C - 27/19)	EERd		9.5	8.3	7.7	7.8	7.7	7.5	7.3	
		Pdc	kW	10.6	13.3	15.9	18.9	21.3	23.9	24.6	
	D Condition (20°C - 27/19)	EERd		18.8	17.0	13.9	14.3	14.2	18.3		
		Pdc	kW	8.0	9.3	9.4	8.4	9.5	11.5		
	Space cooling recommended combination 2	A Condition (35°C - 27/19)	EERd		2.6	2.4		2.6	2.1	1.9	
			Pdc	kW	22.4	28.0	33.5	40.0	45.0	50.4	52.0
B Condition (30°C - 27/19)		EERd		4.9	4.7	4.0	4.1	3.8	3.7	3.6	
		Pdc	kW	16.5	20.6	24.7	29.5	33.2	37.1	38.3	
C Condition (25°C - 27/19)		EERd		8.8	8.5	7.1	7.9	7.6	7.5	7.3	
		Pdc	kW	10.6	13.3	15.9	18.9	21.3	23.9	24.6	
D Condition (20°C - 27/19)		EERd		15.1	17.2	13.1	14.0		18.1	18.9	
		Pdc	kW	8.8	9.3	9.1	8.4	9.5	11.4	10.9	
Space cooling recommended combination 3		A Condition (35°C - 27/19)	EERd		3.0	2.3	2.4	2.6	2.1	1.9	
			Pdc	kW	22.4	28.0	33.5	40.0	45.0	50.4	52.0
	B Condition (30°C - 27/19)	EERd		5.1	4.7	4.2	4.0	3.7		3.6	
		Pdc	kW	16.5	20.6	24.7	29.5	33.2	37.1	38.3	
	C Condition (25°C - 27/19)	EERd		9.6	8.4	7.7		7.4	7.6	7.3	
		Pdc	kW	10.6	13.3	15.9	19.0	21.3	23.9	24.6	
	D Condition (20°C - 27/19)	EERd		16.0	16.9	13.7	14.0	14.1	18.3		
		Pdc	kW	9.1	9.3	9.4	8.4	9.5	11.6		

2 Specifications

2-1 Technical Specifications			RXYQ8U	RXYQ10U	RXYQ12U	RXYQ14U	RXYQ16U	RXYQ18U	RXYQ20U	
Space heating (Average climate)	TBivalent	COPd (declared COP)	2.5	2.4	2.0	2.3	2.2	1.9	1.8	
		Pdh (declared heating cap)	kW	13.7	16.0	18.4	20.6	23.2	27.9	31.0
		Tbiv (bivalent temperature)	°C	-10						
	TOL	COPd (declared COP)	2.5	2.4	2.0	2.3	2.2	1.9	1.8	
		Pdh (declared heating cap)	kW	13.7	16.0	18.4	20.6	23.2	27.9	31.0
		Tol (temperature operating limit)	°C	-10						
	A Condition (-7°C)	COPd (declared COP)	2.7	2.6	2.4	2.6		2.4	2.1	
		Pdh (declared heating cap)	kW	12.1	14.2	16.3	18.2	20.5	24.7	27.4
	B Condition (2°C)	COPd (declared COP)	3.9			3.5		3.7	3.6	
		Pdh (declared heating cap)	kW	7.4	8.6	9.9	11.1	12.5	15.0	16.7
	C Condition (7°C)	COPd (declared COP)	6.3	6.4	6.1		6.3	6.7	6.5	
		Pdh (declared heating cap)	kW	5.0	5.5	6.4	7.1	8.0	9.7	10.7
D Condition (12°C)	COPd (declared COP)	7.9	8.2	7.9	8.5	8.6	9.0	9.1		
	Pdh (declared heating cap)	kW	5.9		6.3	4.9		7.1		
Space heating (Average climate) recommended combination 2	A Condition (-7°C)	COPd (declared COP)	2.7		2.4	2.6		2.4	2.2	
		Pdh (declared heating cap)	kW	12.1	14.2	16.3	18.2	20.5	24.7	27.4
	B Condition (2°C)	COPd (declared COP)	3.9	4.0	3.9	3.5		3.8	3.7	
		Pdh (declared heating cap)	kW	7.4	8.6	9.9	11.1	12.2	15.0	16.7
	C Condition (7°C)	COPd (declared COP)	6.3	6.5	6.1		6.3	6.8	6.5	
		Pdh (declared heating cap)	kW	5.0	5.5	6.4	7.1	8.0	9.7	10.7
	D Condition (12°C)	COPd (declared COP)	7.8	8.3	7.9	8.6	8.7	9.1	9.2	
		Pdh (declared heating cap)	kW	5.9	6.0	6.4	4.9	5.0	7.2	
	TBivalent	COPd (declared COP)	2.4		1.9	2.3	2.2	1.9	1.8	
		Pdh (declared heating cap)	kW	13.7	16.0	18.4	20.6	23.2	27.9	31.0
		Tbiv (bivalent temperature)	°C	-10						
	TOL	COPd (declared COP)	2.4		1.9	2.3	2.2	1.9	1.8	
Pdh (declared heating cap)		kW	13.7	16.0	18.4	20.6	23.2	27.9	31.0	
Tol (temperature operating limit)		°C	-10							

2 Specifications

2

2-1 Technical Specifications				RXYQ8U	RXYQ10U	RXYQ12U	RXYQ14U	RXYQ16U	RXYQ18U	RXYQ20U
Space heating (Average climate) recommended combination 3	A Condition (-7°C)	COPd (declared COP)		2.7	2.6	2.4	2.6		2.4	2.1
		Pdh (declared heating cap)	kW	12.1	14.2	16.3	18.2	20.5	24.7	27.4
	B Condition (2°C)	COPd (declared COP)		3.9	3.7	3.9	3.5		3.7	3.6
		Pdh (declared heating cap)	kW	7.4	8.6	9.9	11.1	12.5	15.0	16.7
	C Condition (7°C)	COPd (declared COP)		6.2	6.4	6.0	6.1	6.2	6.5	6.3
		Pdh (declared heating cap)	kW	4.9	5.5	6.4	7.1	8.0	9.7	10.7
	D Condition (12°C)	COPd (declared COP)		7.8	8.1	7.8	8.5	8.6	8.7	
		Pdh (declared heating cap)	kW	5.8	5.9	6.2	4.9		6.9	
	TBivalent	COPd (declared COP)		2.5	2.4	2.0	2.3	2.2	1.9	1.8
		Pdh (declared heating cap)	kW	13.7	16.0	18.4	20.6	23.2	27.9	31.0
		Tbiv (bivalent temperature)	°C	-10						
	TOL	COPd (declared COP)		2.5	2.4	2.0	2.3	2.2	1.9	1.8
Pdh (declared heating cap)		kW	13.7	16.0	18.4	20.6	23.2	27.9	31.0	
Tol (temperature operating limit)		°C	-10							
Cooling	Cdc (Degradation cooling)			0.25						
Heating	Cdh (Degradation heating)			0.25						
Power consumption in other than active mode	Crankcase heater mode	Cooling	PCK	kW	0.000					
		Heating	PCK	kW	0.052	0.077		0.089		
	Off mode	Cooling	POFF	kW	0.041	0.074		0.075		
		Heating	POFF	kW	0.052	0.077		0.089		
	Standby mode	Cooling	PSB	kW	0.041	0.074		0.075		
		Heating	PSB	kW	0.052	0.077		0.089		
	Thermostat-off mode	Cooling	PTO	kW	0.005	0.010				
		Heating	PTO	kW	0.056	0.097		0.098		
Indication if the heater is equipped with a supplementary heater				no						
Supplementary heater	Back-up capacity	Heating	elbu	kW	0.0					

Standard Accessories : Installation manual; Quantity : 1;

Standard Accessories : Operation manual; Quantity : 1;

Standard Accessories : Connection pipes; Quantity : 1;

2-2 Electrical Specifications				RXYQ8U	RXYQ10U	RXYQ12U	RXYQ14U	RXYQ16U	RXYQ18U	RXYQ20U
Power supply	Name			Y1						
	Phase			3N~						
	Frequency	Hz		50						
	Voltage	V		380-415						
Voltage range	Min.	%		-10						
	Max.	%		10						
Current	Nominal running current (RLA) - 50Hz	Cooling	A	7.2 (7)	10.2 (7)	12.7 (7)	15.4 (7)	18.0 (7)	20.8 (7)	26.9 (7)
Current - 50Hz	Starting current (MSC) - remark			(8)						
	Zmax	List		No requirements						
	Minimum circuit amps (MCA)	A		16.1 (9)	22.0 (9)	24.0 (9)	27.0 (9)	31.0 (9)	35.0 (9)	39.0 (9)
	Maximum fuse amps (MFA)	A		20 (10)	25 (10)	32 (10)		40 (10)		50 (10)
	Full load amps (FLA)	Total	A	1.2 (11)	1.3 (11)	1.5 (11)	1.8 (11)	2.6 (11)		
Wiring connections - 50Hz	For power supply	Quantity		5G						
	For connection with indoor	Quantity		2						
		Remark		F1,F2						
Power supply intake				Both indoor and outdoor unit						

6

2 Specifications

Notes

- (1) Cooling: indoor temp. 27°CDB, 19°CWB; outdoor temp. 35°CDB; equivalent piping length: 7.5m; level difference: 0m
- (2) Heating: indoor temp. 20°CDB; outdoor temp. 7°CDB, 6°CWB; equivalent refrigerant piping: 7.5m; level difference: 0m
- (3) Actual number of connectable indoor units depends on the indoor unit type (VRV indoor, Hydrobox, RA indoor, etc.) and the connection ratio restriction for the system (50% ≤ CR ≤ 130%)
- (4) Sound power level is an absolute value that a sound source generates.
- (5) Sound pressure level is a relative value, depending on the distance and acoustic environment. For more details, please refer to the sound level drawings.
- (6) Refer to refrigerant pipe selection or installation manual
- (7) RLA is based on following conditions: indoor temp. 27°CDB, 19°CWB; outdoor temp. 35°CDB
- (8) MSC means the maximum current during start up of the compressor. VRV IV uses only inverter compressors. Starting current is always ≤ max. running current.
- (9) MCA must be used to select the correct field wiring size. The MCA can be regarded as the maximum running current.
- (10) MFA is used to select the circuit breaker and the ground fault circuit interrupter (earth leakage circuit breaker).
- (11) FLA means the nominal running current of the fan

In accordance with EN/IEC 61000-3-12, it may be necessary to consult the distribution network operator to ensure that the equipment is connected only to a supply with Ssc ≥ minimum Ssc value

Maximum allowable voltage range variation between phases is 2%.

Voltage range: units are suitable for use on electrical systems where voltage supplied to unit terminal is not below or above listed range limits.

The AUTOMATIC ESEER value corresponds with normal VRV4 Heat Pump operation, taking into account advanced energy saving operation functionality (variable refrigerant temperature)

The STANDARD ESEER value corresponds with normal VRV4 Heat Pump operation, not taking into account advanced energy saving operation functionality

Sound values are measured in a semi-anechoic room.

Soundpressure system [dBA] = 10*log[10^(A/10)+10^(B/10)+10^(C/10)] , with Unit A = A dBA, Unit B = B dBA, Unit C = C dBA

EN/IEC 61000-3-12: European/international technical standard setting the limits for harmonic currents produced by equipment connected to public low-voltage system with input current I > 16A and ≤ 75A per phase

Ssc: Short-circuit power

For detailed contents of standard accessories, see installation/operation manual

Multi combination (22~54HP) data is corresponding with the standard multi combination

2-3 Technical Specifications		RXYQ22U	RXYQ24U	RXYQ26U	RXYQ28U	RXYQ30U	RXYQ32U	RXYQ34U	RXYQ36U	RXYQ38U
System	Outdoor unit module 1	RXYQ10 U	RXYQ8U	RXYQ12U			RXYQ16U			RXYQ8U
	Outdoor unit module 2	RXYQ12 U	RXYQ16 U	RXYQ14 U	RXYQ16 U	RXYQ18 U	RXYQ16 U	RXYQ18 U	RXYQ20 U	RXYQ10 U
	Outdoor unit module 3									RXYQ20 U
Recommended combination		6 x FXFQ50 AVEB + 4 x FXFQ63 AVEB	4 x FXFQ50 AVEB + 4 x FXFQ63 AVEB + 2 x FXFQ80 AVEB	7 x FXFQ50 AVEB + 5 x FXFQ63 AVEB	6 x FXFQ50 AVEB + 4 x FXFQ63 AVEB + 2 x FXFQ80 AVEB	9 x FXFQ50 AVEB + 5 x FXFQ63 AVEB	8 x FXFQ63 AVEB + 4 x FXFQ80 AVEB	3 x FXFQ50 AVEB + 9 x FXFQ63 AVEB + 2 x FXFQ80 AVEB	2 x FXFQ50 AVEB + 10 x FXFQ63 AVEB + 2 x FXFQ80 AVEB	6 x FXFQ50 AVEB + 10 x FXFQ63 AVEB
Recommended combination 2		6 x FXSQ50 A2VEB + 4 x FXSQ63 A2VEB	4 x FXSQ50 A2VEB + 4 x FXSQ63 A2VEB + 2 x FXSQ80 A2VEB	7 x FXSQ50 A2VEB + 5 x FXSQ63 A2VEB	6 x FXSQ50 A2VEB + 4 x FXSQ63 A2VEB + 2 x FXSQ80 A2VEB	9 x FXSQ50 A2VEB + 5 x FXSQ63 A2VEB	8 x FXSQ63 A2VEB + 4 x FXSQ80 A2VEB	3 x FXSQ50 A2VEB + 9 x FXSQ63 A2VEB + 2 x FXSQ80 A2VEB	2 x FXSQ50 A2VEB + 10 x FXSQ63 A2VEB + 2 x FXSQ80 A2VEB	6 x FXSQ50 A2VEB + 10 x FXSQ63 A2VEB

2 Specifications

2

2-3 Technical Specifications				RXYQ22U	RXYQ24U	RXYQ26U	RXYQ28U	RXYQ30U	RXYQ32U	RXYQ34U	RXYQ36U	RXYQ38U
Recommended combination 3				6 x FXMQ50 P7VEB + 4 x FXMQ63 P7VEB	4 x FXMQ50 P7VEB + 4 x FXMQ63 P7VEB + 2 x FXMQ80 P7VEB	7 x FXMQ50 P7VEB + 5 x FXMQ63 P7VEB	6 x FXMQ50 P7VEB + 4 x FXMQ63 P7VEB + 2 x FXMQ80 P7VEB	9 x FXMQ50 P7VEB + 5 x FXMQ63 P7VEB	8 x FXMQ63 P7VEB + 4 x FXMQ80 P7VEB	3 x FXMQ50 P7VEB + 9 x FXMQ63 P7VEB + 2 x FXMQ80 P7VEB	2 x FXMQ50 P7VEB + 10 x FXMQ63 P7VEB + 2 x FXMQ80 P7VEB	6 x FXMQ50 P7VEB + 10 x FXMQ63 P7VEB
Cooling capacity	Prated,c		kW	61.5 (1)	67.4 (1)	73.5 (1)	78.5 (1)	83.9 (1)	90.0 (1)	95.4 (1)	97.0 (1)	102.4 (1)
Heating capacity	Prated,h		kW	34.4	36.9	39.0	41.6	46.3	46.4	51.1	54.2	60.7
	Max.	6°CWB	kW	69.0 (2)	75.0 (2)	82.5 (2)	87.5 (2)	94.0 (2)	100.0 (2)	106.5 (2)	113.0 (2)	119.5 (2)
SEER				6.9	6.8	6.7	6.5		6.4		6.3	6.9
SEER recommended combination 2				6.7	6.6	6.5	6.3					6.8
SEER recommended combination 3				6.9	6.7	6.6	6.4	6.5	6.2	6.3		6.9
SCOP				4.4	4.3	4.2		4.3	4.2		4.1	4.3
SCOP recommended combination 2				4.4	4.3	4.2		4.3	4.2	4.3	4.2	4.3
SCOP recommended combination 3				4.3	4.2			4.3	4.1	4.2	4.1	4.2
ηs,c			%	274.5	269.9	264.2	257.8	256.8	251.7	253.3	250.8	272.4
ηs,c recommended combination 2				266.5	262.6	256.1	249.3	249.8	248.3	250.9	248.7	269.2
ηs,c recommended combination 3				273.3	265.3	261.1	253.1	256.1	244.2	249.8	247.2	272.2
ηs,h			%	171.2	167.0	164.6	166.0	169.8	163.1	166.2	162.4	167.5
ηs,h recommended combination 2				172.3	167.1	165.4	166.8	170.6	164.6	167.7	164.1	168.4
ηs,h recommended combination 3				170.2	165.5	164.5	165.0	167.0	161.9	164.2	159.9	164.8
Capacity range			HP	22	24	26	28	30	32	34	36	38
Maximum number of connectable indoor units				64 (3)								
Indoor index connection	Min.			275.0	300.0	325.0	350.0	375.0	400.0	425.0	450.0	475.0
	Max.			715.0	780.0	845.0	910.0	975.0	1,040.0	1,105.0	1,170.0	1,235.0
Heat exchanger	Indoor side			Air								
	Outdoor side			Air								
	Air flow rate	Cooling	Rated	m³/h	21,600	25,320	24,480	26,700	26,160	31,200	30,660	31,260
Heating		Rated	m³/h	21,600	25,320	24,480	26,700	26,160	31,200	30,660	31,260	35,880
Sound power level	Cooling	Nom.	dBA	84.8 (4)	86.3 (4)	85.3 (4)	87.6 (4)	86.6 (4)	88.6 (4)	87.8 (4)	89.9 (4)	88.8 (4)
	Heating	Nom.	dBA	67.8 (4)	69.6 (4)	69.9 (4)	70.1 (4)	68.7 (4)	71.6 (4)	70.6 (4)	70.9 (4)	69.9 (4)
Sound pressure level	Cooling	Nom.	dBA	62.5 (5)	64.0 (5)	63.5 (5)	65.1 (5)	64.5 (5)	66.0 (5)	65.5 (5)	67.1 (5)	66.2 (5)
Refrigerant	Type			R-410A								
	GWP			2,087.5								
Refrigerant oil	Type			Synthetic (ether) oil FVC68D								
Piping connections	Liquid	Type		Braze connection								
		OD	mm	15,9			19,1					
	Gas	Type		Braze connection								
		OD	mm	28.6	34.9					41.3		
Total piping length	System	Actual	m	1,000 (6)								
PED	Category			Category II								
Space cooling	A Condition (35°C - 27/19)	EERd		2.6	2.5	2.6	2.3	2.1	2.3	2.1		2.4
		Pdc	kW	61.5	67.4	73.5	78.5	83.9	90.0	95.4	97.0	102.4
	B Condition (30°C - 27/19)	EERd		4.8	4.6		4.4	4.3		4.2	4.1	4.5
		Pdc	kW	45.3	49.7	54.2	57.8	61.8	66.3	70.3	71.5	75.5
	C Condition (25°C - 27/19)	EERd		8.5	8.6	8.2	8.1	8.2	8.1		7.9	8.5
		Pdc	kW	29.1	31.9	34.8	37.2	39.7	42.6	45.2	45.9	48.5
	D Condition (20°C - 27/19)	EERd		16.0	15.2	14.2	14.3	16.8	14.3	16.8	16.7	17.9
		Pdc	kW	18.8	15.8	16.2	16.5	21.0	19.0	20.1	20.4	21.6
Space cooling recommended combination 2	A Condition (35°C - 27/19)	EERd		2.6	2.4	2.6	2.3	2.1	2.2	2.1		2.3
		Pdc	kW	61.5	67.4	73.5	78.5	83.9	90.0	95.4	97.0	102.4
	B Condition (30°C - 27/19)	EERd		4.6	4.5	4.4	4.3	4.2		4.1	4.5	
		Pdc	kW	45.3	49.7	54.1	57.8	61.8	66.3	70.3	71.5	75.4
	C Condition (25°C - 27/19)	EERd		8.2	8.4	7.9	7.8	7.9	8.0	8.1	7.9	8.4
		Pdc	kW	29.1	31.9	34.8	37.2	39.7	42.6	45.2	45.9	48.5
	D Condition (20°C - 27/19)	EERd		15.6	14.7	13.6	13.8	16.1	14.0	16.5		17.8
		Pdc	kW	18.4	15.4	15.7	16.5	20.5	18.9	20.1	20.4	21.6

8

2 Specifications

2-3 Technical Specifications			RXYQ22U	RXYQ24U	RXYQ26U	RXYQ28U	RXYQ30U	RXYQ32U	RXYQ34U	RXYQ36U	RXYQ38U	
Space cooling recommended combination 3	A Condition (35°C - 27/19)	EERd	2.5			2.3	2.1	2.2	2.1		2.4	
		Pdc	kW	61.5	67.4	73.5	78.5	83.9	90.0	95.4	97.0	102.4
	B Condition (30°C - 27/19)	EERd	4.8	4.5		4.3		4.1		4.0	4.5	
		Pdc	kW	45.3	49.7	54.2	57.8	61.8	66.3	70.3	71.5	75.5
	C Condition (25°C - 27/19)	EERd	8.5	8.4	8.1	8.0	8.2	7.8	8.0	7.8	8.5	
		Pdc	kW	29.1	31.9	34.8	37.2	39.7	42.6	45.2	45.9	48.5
	D Condition (20°C - 27/19)	EERd	15.8	15.2	14.0	14.1	16.6	13.8	16.6	16.5	17.9	
		Pdc	kW	18.8	15.7	16.0	16.6	21.0	19.0	20.1	20.4	21.6
Space heating (Average climate)	TBivalent	COPd (declared COP)	2.3	2.5	2.3	2.2	2.1	2.4	2.2	2.1	2.2	
		Pdh (declared heating cap)	kW	34.4	36.9	39.0	41.6	46.3	46.4	51.1	54.2	60.7
		Tbiv (bivalent temperature)	°C	-10								
	TOL	COPd (declared COP)	2.3	2.5	2.3	2.2	2.1	2.4	2.2	2.1	2.2	
		Pdh (declared heating cap)	kW	34.4	36.9	39.0	41.6	46.3	46.4	51.1	54.2	60.7
		Tol (temperature operating limit)	°C	-10								
	A Condition (-7°C)	COPd (declared COP)	2.6	2.8	2.6		2.7	2.6	2.5			
		Pdh (declared heating cap)	kW	30.4	32.6	34.5	36.8	41.0		45.2	47.9	53.7
	B Condition (2°C)	COPd (declared COP)	4.0	3.7	3.8		3.9	3.6	3.7		3.9	
		Pdh (declared heating cap)	kW	18.5	19.9	21.0	22.4	24.9	25.0	27.5	29.2	32.7
	C Condition (7°C)	COPd (declared COP)	6.3		6.1	6.2	6.5	6.3	6.5	6.4	6.5	
		Pdh (declared heating cap)	kW	11.9	13.0	13.5	14.4	16.0	16.1	17.7	18.8	21.3
	D Condition (12°C)	COPd (declared COP)	8.2	8.9	8.8	9.0		8.8	8.6	8.7		
		Pdh (declared heating cap)	kW	6.0	5.7	6.0	6.4	7.1		7.9	8.3	13.1
	Space heating (Average climate) recommended combination 2	A Condition (-7°C)	COPd (declared COP)	2.6	2.7	2.6		2.7	2.6	2.5		
			Pdh (declared heating cap)	kW	30.4	32.6	34.5	36.8	41.0		45.2	47.9
		B Condition (2°C)	COPd (declared COP)	4.1	3.7	3.8		3.9	3.6	3.8	3.7	3.9
			Pdh (declared heating cap)	kW	18.5	19.9	21.0	22.4	24.9	25.0	27.5	29.2
C Condition (7°C)		COPd (declared COP)	6.3		6.1	6.3	6.6	6.3	6.6	6.5		
		Pdh (declared heating cap)	kW	11.9	13.1		14.4	16.0	16.1	17.7	18.8	21.3
D Condition (12°C)		COPd (declared COP)	8.4	9.0	8.9	9.1		8.9	8.8			
		Pdh (declared heating cap)	kW	6.0	5.7	6.0	6.4	7.2	7.1	7.9	8.3	13.2
TBivalent		COPd (declared COP)	2.2	2.4	2.2		2.1	2.4	2.2		2.3	
		Pdh (declared heating cap)	kW	34.4	36.9	39.0	41.6	46.3	46.4	51.1	54.2	60.7
		Tbiv (bivalent temperature)	°C	-10								
TOL		COPd (declared COP)	2.2	2.4	2.2		2.1	2.4	2.2		2.3	
		Pdh (declared heating cap)	kW	34.4	36.9	39.0	41.6	46.3	46.4	51.1	54.2	60.7
		Tol (temperature operating limit)	°C	-10								

2 Specifications

2

2-3 Technical Specifications					RXYQ22U	RXYQ24U	RXYQ26U	RXYQ28U	RXYQ30U	RXYQ32U	RXYQ34U	RXYQ36U	RXYQ38U
Space heating (Average climate) recommended combination 3	A Condition (-7°C)	COPd (declared COP)			2.6	2.7	2.6		2.5	2.7	2.6	2.4	2.5
		Pdh (declared heating cap)	kW		30.4	32.6	34.5	36.8	41.0		45.2	47.9	53.7
	B Condition (2°C)	COPd (declared COP)			4.0	3.7	3.8		3.9	3.6	3.7	3.6	3.8
		Pdh (declared heating cap)	kW		18.5	19.9	21.0	22.4	24.9	25.0	27.5	29.2	32.7
	C Condition (7°C)	COPd (declared COP)			6.2	6.3	6.1	6.2	6.3		6.4	6.3	
		Pdh (declared heating cap)	kW		11.9	12.9	13.5	14.4	16.0	16.1	17.7	18.8	21.2
	D Condition (12°C)	COPd (declared COP)			8.2	8.9	8.8	9.0	8.6	9.0	8.9	8.3	8.5
		Pdh (declared heating cap)	kW		6.0	5.7	6.0	6.4	7.1		7.9	8.3	12.9
	TBivalent	COPd (declared COP)			2.3	2.4	2.2		2.1	2.4	2.2	2.1	2.2
		Pdh (declared heating cap)	kW		34.4	36.9	39.0	41.6	46.3	46.4	51.1	54.2	60.7
		Tbiv (bivalent temperature)	°C		-10								
	TOL	COPd (declared COP)			2.3	2.4	2.2		2.1	2.4	2.2	2.1	2.2
Pdh (declared heating cap)		kW		34.4	36.9	39.0	41.6	46.3	46.4	51.1	54.2	60.7	
Tol (temperature operating limit)		°C		-10									
Cooling	Cdc (Degradation cooling)			0.25									
Heating	Cdh (Degradation heating)			0.25									
Power consumption in other than active mode	Off mode	Cooling	POFF	kW	0.081	0.115		0.116	0.149	0.150	0.157		
		Heating	POFF	kW	0.103	0.129		0.141	0.154	0.166	0.192		
	Standby mode	Cooling	PSB	kW	0.081	0.115		0.116	0.149	0.150	0.157		
		Heating	PSB	kW	0.103	0.129		0.141	0.154	0.166	0.192		
	Thermostat-off mode	Cooling	PTO	kW	0.009	0.014			0.019				
		Heating	PTO	kW	0.113	0.154		0.155	0.195	0.196	0.211		
Indication if the heater is equipped with a supplementary heater				no									
Supplementary heater	Back-up capacity	Heating	elbu	kW	0.0								

Standard Accessories : Installation manual; Quantity : 1;

Standard Accessories : Operation manual; Quantity : 1;

Standard Accessories : Connection pipes; Quantity : 1;

2-4 Technical Specifications				RXYQ40U	RXYQ42U	RXYQ44U	RXYQ46U	RXYQ48U	RXYQ50U	RXYQ52U	RXYQ54U	
System	Outdoor unit module 1			RXYQ10U		RXYQ12U	RXYQ14U	RXYQ16U			RXYQ18U	
	Outdoor unit module 2			RXYQ12U	RXYQ16U						RXYQ18U	
	Outdoor unit module 3			RXYQ18U	RXYQ16U					RXYQ18U		
Recommended combination				9 x FXFQ50A VEB + 9 x FXFQ63A VEB	12 x FXFQ63A VEB + 4 x FXFQ80A VEB	6 x FXFQ50A VEB + 8 x FXFQ63A VEB + 4 x FXFQ80A VEB	1 x FXFQ50A VEB + 13 x FXFQ63A VEB + 4 x FXFQ80A VEB	12 x FXFQ63A VEB + 6 x FXFQ80A VEB	3 x FXFQ50A VEB + 13 x FXFQ63A VEB + 4 x FXFQ80A VEB	6 x FXFQ50A VEB + 14 x FXFQ63A VEB + 2 x FXFQ80A VEB	9 x FXFQ50A VEB + 15 x FXFQ63A VEB	
Recommended combination 2				9 x FXSQ50A 2VEB + 9 x FXSQ63A 2VEB	12 x FXSQ63A 2VEB + 4 x FXSQ80A 2VEB	6 x FXSQ50A 2VEB + 8 x FXSQ63A 2VEB + 4 x FXSQ80A 2VEB	1 x FXSQ50A 2VEB + 13 x FXSQ63A 2VEB + 4 x FXSQ80A 2VEB	12 x FXSQ63A 2VEB + 6 x FXSQ80A 2VEB	3 x FXSQ50A 2VEB + 13 x FXSQ63A 2VEB + 4 x FXSQ80A 2VEB	6 x FXSQ50A 2VEB + 14 x FXSQ63A 2VEB + 2 x FXSQ80A 2VEB	9 x FXSQ50A 2VEB + 15 x FXSQ63A 2VEB	

2 Specifications

2-4 Technical Specifications				RXYQ40U	RXYQ42U	RXYQ44U	RXYQ46U	RXYQ48U	RXYQ50U	RXYQ52U	RXYQ54U		
Recommended combination 3				9 x FXMQ50P 7VEB + 9 x FXMQ63P 7VEB	12 x FXMQ63P 7VEB + 4 x FXMQ80P 7VEB	6 x FXMQ50P 7VEB + 8 x FXMQ63P 7VEB + 4 x FXMQ80P 7VEB	1 x FXMQ50P 7VEB + 13 x FXMQ63P 7VEB + 4 x FXMQ80P 7VEB	12 x FXMQ63P 7VEB + 6 x FXMQ80P 7VEB	3 x FXMQ50P 7VEB + 13 x FXMQ63P 7VEB + 4 x FXMQ80P 7VEB	6 x FXMQ50P 7VEB + 14 x FXMQ63P 7VEB + 2 x FXMQ80P 7VEB	9 x FXMQ50P 7VEB + 15 x FXMQ63P 7VEB		
Cooling capacity	Prated,c		kW	111.9 (1)	118.0 (1)	123.5 (1)	130.0 (1)	135.0 (1)	140.4 (1)	145.8 (1)	151.2 (1)		
Heating capacity	Prated,h		kW	62.3	62.4	64.8	67.0	69.6	74.3	79.0	83.7		
	Max.	6°CWB	kW	125.5 (2)	131.5 (2)	137.5 (2)	145.0 (2)	150.0 (2)	156.5 (2)	163.0 (2)	169.5 (2)		
SEER				6.7	6.6	6.5	6.4						
SEER recommended combination 2				6.6		6.3	6.4	6.3		6.4			
SEER recommended combination 3				6.7	6.5	6.3		6.2	6.3	6.4			
SCOP				4.3	4.2		4.1		4.2	4.3			
SCOP recommended combination 2				4.4	4.3	4.2					4.3		
SCOP recommended combination 3				4.3	4.2		4.1		4.2				
ηs,c	%			263.5	261.2	255.9	254.9	251.7	252.8	253.7	254.1		
ηs,c recommended combination 2				259.2	259.3	249.2	252.2	248.3	250.0	251.6	252.5		
ηs,c recommended combination 3				263.2	255.4	250.1	248.3	244.2	248.0	251.5	253.9		
ηs,h	%			170.0	165.5	164.5	162.0	162.8	165.2	167.2	169.4		
ηs,h recommended combination 2				171.3	167.3	165.6	163.5	164.3	166.7	168.7	170.8		
ηs,h recommended combination 3				167.8	164.4	163.5	161.3	161.7	163.2	164.4	166.0		
Capacity range				HP		40	42	44	46	48	50	52	54
Maximum number of connectable indoor units				64 (3)									
Indoor index connection	Min.			500.0	525.0	550.0	575.0	600.0	625.0	650.0	675.0		
	Max.			1,300.0	1,365.0	1,430.0	1,495.0	1,560.0	1,625.0	1,690.0	1,755.0		
Heat exchanger	Indoor side			Air									
	Outdoor side			Air									
	Air flow rate	Cooling	Rated	m³/h	36,660	41,700	42,300	44,580	46,800	46,260	45,720	45,180	
		Heating	Rated	m³/h	36,660	41,700	42,300	44,580	46,800	46,260	45,720	45,180	
Sound power level	Cooling	Nom.	dBA	87.3 (4)	89.1 (4)	89.8 (4)	89.3 (4)	90.4 (4)	89.8 (4)	89.3 (4)	88.6 (4)		
	Heating	Nom.	dBA	70.2 (4)	72.4 (4)		73.3 (4)	73.4 (4)	72.7 (4)	72.0 (4)	71.1 (4)		
Sound pressure level	Cooling	Nom.	dBA	65.2 (5)	66.5 (5)	67.2 (5)	67.0 (5)	67.8 (5)	67.5 (5)	67.1 (5)	66.8 (5)		
Refrigerant	Type			R-410A									
	GWP			2,087.5									
Refrigerant oil	Type			Synthetic (ether) oil FVC68D									
Piping connections	Liquid	Type		Braze connection									
		OD	mm	19.1									
	Gas	Type		Braze connection									
		OD	mm	41.3									
Total piping length	System	Actual	m		1,000 (6)								
PED	Category			Category II									
Space cooling	A Condition (35°C - 27/19)	EERd	2.2		2.3		2.4	2.3	2.1	2.0	1.9		
		Pdc	kW	111.9	118.0	123.5	130.0	135.0	140.4	145.8	151.2		
	B Condition (30°C - 27/19)	EERd	4.5		4.4		4.3		4.2		4.1		
		Pdc	kW	82.5	86.9	91.0	95.8	99.5	103.4	107.4	111.4		
	C Condition (25°C - 27/19)	EERd	8.3		8.2		8.1						
		Pdc	kW	53.0	55.9	58.5	61.6	64.0	66.5	69.1	71.6		
	D Condition (20°C - 27/19)	EERd	16.0		15.4		14.4		14.3		15.9	17.6	19.1
		Pdc	kW	23.6	24.8	26.0	27.4	28.4	29.6	30.7	34.4		
Space cooling recommended combination 2	A Condition (35°C - 27/19)	EERd	2.2		2.3		2.2		2.1	2.0	1.9		
		Pdc	kW	111.9	118.0	123.5	130.0	135.0	140.4	145.8	151.2		
	B Condition (30°C - 27/19)	EERd	4.4		4.3		4.2		4.1				
		Pdc	kW	82.4	86.9	91.0	95.8	99.5	103.5	107.4	111.4		
	C Condition (25°C - 27/19)	EERd	8.1		8.2		7.9		8.1		8.0		
		Pdc	kW	53.0	55.9	58.5	61.6	63.9	66.5	69.0	71.6		
	D Condition (20°C - 27/19)	EERd	15.9		15.3		14.0		15.6		17.4	18.9	
		Pdc	kW	23.6	24.8	26.0	27.4	28.4	29.6	30.7	34.1		

2 Specifications

2

2-4 Technical Specifications			RXYQ40U	RXYQ42U	RXYQ44U	RXYQ46U	RXYQ48U	RXYQ50U	RXYQ52U	RXYQ54U		
Space cooling recommended combination 3	A Condition (35°C - 27/19)	EERd	2.2	2.3			2.2	2.1	2.0	1.9		
		Pdc	111.9	118.0	123.5	130.0	135.0	140.4	145.8	151.2		
	B Condition (30°C - 27/19)	EERd	4.4	4.3			4.2	4.1				
		Pdc	82.5	87.0	91.0	95.8	99.5	103.5	107.4	111.4		
	C Condition (25°C - 27/19)	EERd	8.4	8.0	7.9			7.8	7.9	8.0	8.2	
		Pdc	53.0	55.9	58.5	61.6	63.9	66.5	69.1	71.6		
	D Condition (20°C - 27/19)	EERd	16.1	15.2	14.2	13.9	13.8	15.6	17.5	19.1		
		Pdc	23.6	24.8	26.0	27.4	28.4	29.6	30.7	34.7		
Space heating (Average climate)	TBivalent	COPd (declared COP)	2.2	2.4	2.3	2.4		2.3	2.2	2.1		
		Pdh (declared heating cap)	62.3	62.4	64.8	67.0	69.6	74.3	79.0	83.7		
		Tbiv (bivalent temperature)	-10									
	TOL	COPd (declared COP)	2.2	2.4	2.3	2.4		2.3	2.2	2.1		
		Pdh (declared heating cap)	62.3	62.4	64.8	67.0	69.6	74.3	79.0	83.7		
		Tol (temperature operating limit)	-10									
	A Condition (-7°C)	COPd (declared COP)	2.6	2.7					2.6			
		Pdh (declared heating cap)	55.1	55.2	57.3	59.3	61.6	65.7	69.9	74.0		
	B Condition (2°C)	COPd (declared COP)	4.0	3.7			3.6		3.7	3.8	3.9	
		Pdh (declared heating cap)	33.5	33.6	34.9	36.1	37.5	40.0	42.5	45.1		
	C Condition (7°C)	COPd (declared COP)	6.5	6.3			6.2	6.3	6.5	6.6	6.8	
		Pdh (declared heating cap)	21.6		22.4	23.2	24.1	25.7	27.4	29.0		
	D Condition (12°C)	COPd (declared COP)	8.7	8.6			8.7	8.8	8.9	9.0		
		Pdh (declared heating cap)	13.1	9.9	10.0	10.3	10.7	12.0	14.2			
	Space heating (Average climate) recommended combination 2	A Condition (-7°C)	COPd (declared COP)	2.6	2.7					2.6		
			Pdh (declared heating cap)	55.1	55.2	57.3	59.3	61.6	65.7	69.9	74.0	
		B Condition (2°C)	COPd (declared COP)	4.0	3.7			3.6		3.7	3.8	3.9
			Pdh (declared heating cap)	33.5	33.6	34.9	36.1	37.5	40.0	42.6	45.1	
C Condition (7°C)		COPd (declared COP)	6.5	6.4	6.3			6.5	6.7	6.8		
		Pdh (declared heating cap)	21.6		22.4	22.8	24.1	25.7	27.4	29.0		
D Condition (12°C)		COPd (declared COP)	8.8	8.7			8.8	8.9	9.0	9.1		
		Pdh (declared heating cap)	13.2	10.0			10.3	10.7	12.2	14.4		
TBivalent		COPd (declared COP)	2.2	2.4	2.3	2.4		2.3	2.2	2.1		
		Pdh (declared heating cap)	62.3	62.4	64.8	67.0	69.6	74.3	79.0	83.7		
		Tbiv (bivalent temperature)	-10									
TOL		COPd (declared COP)	2.2	2.4	2.3	2.4		2.3	2.2	2.1		
		Pdh (declared heating cap)	62.3	62.4	64.8	67.0	69.6	74.3	79.0	83.7		
		Tol (temperature operating limit)	-10									

2 Specifications

2-4 Technical Specifications					RXYQ40U	RXYQ42U	RXYQ44U	RXYQ46U	RXYQ48U	RXYQ50U	RXYQ52U	RXYQ54U
Space heating (Average climate) recommended combination 3	A Condition (-7°C)	COPd (declared COP)			2.6	2.7	2.6	2.7		2.6		2.5
		Pdh (declared heating cap)	kW		55.1	55.2	57.3	59.3	61.6	65.7	69.9	74.0
	B Condition (2°C)	COPd (declared COP)			3.9	3.7		3.6		3.7	3.8	
		Pdh (declared heating cap)	kW		33.5	33.6	34.9	36.1	37.5	40.0	42.5	45.1
	C Condition (7°C)	COPd (declared COP)			6.4	6.3	6.2		6.3	6.4		6.5
		Pdh (declared heating cap)	kW		21.6		22.4	23.2	24.1	25.7	27.3	29.0
	D Condition (12°C)	COPd (declared COP)			8.4	8.6		8.7	8.8	8.7		
		Pdh (declared heating cap)	kW		12.8	9.9	10.0	10.3	10.7	11.8	13.7	
	TBivalent	COPd (declared COP)			2.2	2.4	2.3	2.4		2.2		2.1
		Pdh (declared heating cap)	kW		62.3	62.4	64.8	67.0	69.6	74.3	79.0	83.7
		Tbiv (bivalent temperature)	°C		-10							
	TOL	COPd (declared COP)			2.2	2.4	2.3	2.4		2.2		2.1
		Pdh (declared heating cap)	kW		62.3	62.4	64.8	67.0	69.6	74.3	79.0	83.7
		Tol (temperature operating limit)	°C		-10							
	Cooling	Cdc (Degradation cooling)			0.25							
Heating	Cdh (Degradation heating)			0.25								
Power consumption in other than active mode	Off mode	Cooling	POFF	kW	0.157	0.190		0.223		0.224	0.225	0.226
		Heating	POFF	kW	0.192	0.206		0.231		0.243	0.255	0.267
	Standby mode	Cooling	PSB	kW	0.157	0.190		0.223		0.224	0.225	0.226
		Heating	PSB	kW	0.192	0.206		0.231		0.243	0.255	0.267
	Thermostat-off mode	Cooling	PTO	kW	0.019	0.024		0.029				
		Heating	PTO	kW	0.211	0.251		0.292		0.293	0.294	
Indication if the heater is equipped with a supplementary heater				no								
Supplementary heater	Back-up capacity	Heating	elbu	kW	0.0							

Standard Accessories : Installation manual; Quantity : 1;

Standard Accessories : Operation manual; Quantity : 1;

Standard Accessories : Connection pipes; Quantity : 1;

2-5 Electrical Specifications				RXYQ22U	RXYQ24U	RXYQ26U	RXYQ28U	RXYQ30U	RXYQ32U	RXYQ34U	RXYQ36U	RXYQ38U
Power supply	Name			Y1								
	Phase			3N~								
	Frequency			50								
	Voltage			380-415								
Voltage range	Min.			-10								
	Max.			10								
Current	Nominal running current (RLA) - 50Hz	Cooling	A	22.9 (7)	25.2 (7)	28.1 (7)	30.7 (7)	33.5 (7)	36.0 (7)	38.8 (7)	44.9 (7)	44.3 (7)
Current - 50Hz	Starting current (MSC) - remark			(8)								
	Zmax	List		No requirements								
	Minimum circuit amps (MCA)			A	46.0 (9)	51.0 (9)	55.0 (9)	59.0 (9)	62.0 (9)	66.0 (9)	70.0 (9)	76.0 (9)
	Maximum fuse amps (MFA)			A	63 (10)			80 (10)			100 (10)	
Wiring connections - 50Hz	For power supply	Quantity		5G								
	For connection with indoor	Quantity		2								
	Remark		F1,F2									
Power supply intake				Both indoor and outdoor unit								

2-6 Electrical Specifications				RXYQ40U	RXYQ42U	RXYQ44U	RXYQ46U	RXYQ48U	RXYQ50U	RXYQ52U	RXYQ54U	
Power supply	Name			Y1								
	Phase			3N~								
	Frequency			50								
	Voltage			380-415								

2 Specifications

2

2-6 Electrical Specifications				RXYQ40U	RXYQ42U	RXYQ44U	RXYQ46U	RXYQ48U	RXYQ50U	RXYQ52U	RXYQ54U
Voltage range	Min.			-10							
	Max.			10							
Current	Nominal running current (RLA) - 50Hz	Cooling	A	43.7 (7)	46.2 (7)	48.7 (7)	51.4 (7)	54.0 (7)	56.8 (7)	59.6 (7)	62.4 (7)
Current - 50Hz	Starting current (MSC) - remark		(8)								
	Zmax	List	No requirements								
	Minimum circuit amps (MCA)		A	81.0 (9)	84.0 (9)	86.0 (9)	89.0 (9)	93.0 (9)	97.0 (9)	101.0 (9)	105.0 (9)
	Maximum fuse amps (MFA)		A	100 (10)				125 (10)			
Wiring connections - 50Hz	For power supply	Quantity	5G								
	For connection with indoor	Quantity	2								
		Remark	F1,F2								
Power supply intake			Both indoor and outdoor unit								

Notes

- (1) Cooling: indoor temp. 27°CDB, 19°CWB; outdoor temp. 35°CDB; equivalent piping length: 7.5m; level difference: 0m
 - (2) Heating: indoor temp. 20°CDB; outdoor temp. 7°CDB, 6°CWB; equivalent refrigerant piping: 7.5m; level difference: 0m
 - (3) Actual number of connectable indoor units depends on the indoor unit type (VRV indoor, Hydrobox, RA indoor, etc.) and the connection ratio restriction for the system (50% ≤ CR ≤ 130%)
 - (4) Sound power level is an absolute value that a sound source generates.
 - (5) Sound pressure level is a relative value, depending on the distance and acoustic environment. For more details, please refer to the sound level drawings.
 - (6) Refer to refrigerant pipe selection or installation manual
 - (7) RLA is based on following conditions: indoor temp. 27°CDB, 19°CWB; outdoor temp. 35°CDB
 - (8) MSC means the maximum current during start up of the compressor. VRV IV uses only inverter compressors. Starting current is always ≤ max. running current.
 - (9) MCA must be used to select the correct field wiring size. The MCA can be regarded as the maximum running current.
 - (10) MFA is used to select the circuit breaker and the ground fault circuit interrupter (earth leakage circuit breaker).
- In accordance with EN/IEC 61000-3-12, it may be necessary to consult the distribution network operator to ensure that the equipment is connected only to a supply with Ssc ≥ minimum Ssc value
- FLA means the nominal running current of the fan
- Maximum allowable voltage range variation between phases is 2%.
- Voltage range: units are suitable for use on electrical systems where voltage supplied to unit terminal is not below or above listed range limits.
- The AUTOMATIC ESEER value corresponds with normal VRV4 Heat Pump operation, taking into account advanced energy saving operation functionality (variable refrigerant temperature)
- The STANDARD ESEER value corresponds with normal VRV4 Heat Pump operation, not taking into account advanced energy saving operation functionality
- Sound values are measured in a semi-anechoic room.
- Soundpressure system [dBA] = $10 \cdot \log[10^{A/10} + 10^{B/10} + 10^{C/10}]$, with Unit A = A dBA, Unit B = B dBA, Unit C = C dBA
- EN/IEC 61000-3-12: European/international technical standard setting the limits for harmonic currents produced by equipment connected to public low-voltage system with input current > 16A and ≤ 75A per phase
- Ssc: Short-circuit power
- For detailed contents of standard accessories, see installation/operation manual
- Multi combination (22~54HP) data is corresponding with the standard multi combination

3 Options

3 - 1 Options

RXYQQ-U
RXYQ-U
RYYQ-U
RYMQ-U

No	Item	RXYQ8U RYYQ8U RXYQQ8U		RXYQ10-12U RYYQ10-12U RXYQQ10-12U		RXYQ14-18U RYYQ14-18U RXYQQ14-18U		RXYQ20U RYYQ20U RXYQQ20U		RYYQ22~54U RXYQ22~54U RXYQQ22~42U	
I.	Refnet header	KHRQ22M29H									
		KHRQ22M64H									
		---	---	---	KHRQ22M75H						
II.	Refnet joint	KHRQ22M20T									
		KHRQ22M29T9									
		KHRQ22M64T									
		---	---	---	KHRQ22M75T						
III.	Outdoor multi-connection kit	See note 2.	---	---	---	---	---	---	---	BHFQ22P1007	
IV.	Outdoor multi-connection kit	See note 2.	---	---	---	---	---	---	---	BHFQ22P1517	
No	Item	8HP	10HP	12HP	14HP	16HP	18HP	20HP			
1a	Cool/heat selector (switch)	See note 4.	KRC19-26A								
1b	Cool/heat selector (PCB)	BRP2A81									
1c	Cool/heat selector (fixing box)	KJB111A									
2	VRV configurator	EKPCAB*									
3	Heater tape kit PCB	EKBP012T7A				EKBP020T7A					
4	Demand PCB	See note 5.	DTA104A61/62*								
5	Demand PCB mounting plate	See note 5.	---			KKS26B1*					

Notes

- 1 All options are kits
- 2 Only for multi units
- 3 To operate the cool/heat selector function, options 1a and 1b are both required.
- 4 To mount option 1a, option 1c is required.
- 5 To install the demand PCB on the large casing type, the demand PCB mounting plate is required.

Medium casing type VRV4 heat pump: modules 8~12HP
Large casing type VRV4 heat pump: modules 14~20HP

3D120006

4 Combination table

4 - 1 Combination Table

4

RXYQQ-U
RXYQ-U
RYYQ-U
RYMQ-U

Heat pump VRV4
Multi-unit standard combinations table

		8HP	10HP	12HP	14HP	16HP	18HP	20HP
Heat pump	RXYQ8* / RYYQ8* / RXYQ08*	1						
	RXYQ10* / RYYQ10* / RXYQ10*		1					
	RXYQ12* / RYYQ12* / RXYQ12*			1				
	RXYQ14* / RYYQ14* / RXYQ14*				1			
	RXYQ16* / RYYQ16* / RXYQ16*					1		
	RXYQ18* / RYYQ18* / RXYQ18*						1	
	RXYQ20* / RYYQ20* / RXYQ20*							1
Multi-combination with 2 outdoor units	RXYQ22* / RYYQ22* / RXYQ22*		1	1				
	RXYQ24* / RYYQ24* / RXYQ24*	1				1		
	RXYQ26* / RYYQ26* / RXYQ26*			1	1			
	RXYQ28* / RYYQ28* / RXYQ28*			1		1		
	RXYQ30* / RYYQ30* / RXYQ30*			1			1	
	RXYQ32* / RYYQ32* / RXYQ32*					2		
	RXYQ34* / RYYQ34* / RXYQ34*						1	1
	RXYQ36* / RYYQ36* / RXYQ36*							1
Multi-combination with 3 outdoor units	RXYQ38* / RYYQ38* / RXYQ38*	1	1					1
	RXYQ40* / RYYQ40* / RXYQ40*		1	1				1
	RXYQ42* / RYYQ42* / RXYQ42*			1		2		
	RXYQ44* / RYYQ44*			1		2		
	RXYQ46* / RYYQ46*				1	2		
	RXYQ48* / RYYQ48*						3	
	RXYQ50* / RYYQ50*						2	1
	RXYQ52* / RYYQ52*						1	2
	RXYQ54* / RYYQ54*							3

Remark

- RXYQ8~20 = Single continuous heating
- RYYQ22~54 Multi continuous heating
- RXYQ8~20 = Single non-continuous heating
- RXYQ22~54 Multi non-continuous heating
- RXYQ8~20 Single non-continuous heating replacement (VRV4-Q)
- RXYQ22~54 Multi non-continuous heating replacement (VRV4-Q)
- 1) For single unit installation: RYYQ* units (continuous heating) and RXYQ* units (non-continuous heating)
- 2) "Non-continuous heating" multi-outdoor-unit combinations consist of RXYQ8~20 units (e.g. RXYQ36*-RXYQ16*+RXYQ20*).
- 3) "Continuous heating" multi-outdoor-unit combinations consist of RYM08~20 units (e.g. RYYQ36*-RYMQ16*+RYMQ20*).
- RYM08~20 units can only be used in multi-outdoor-unit combinations and cannot be used as standalone units.
- 4) RXYQ8~20* units cannot be used in multi-outdoor-unit combinations.
- 5) RYYQ8~20 "Continuous heating" multi-outdoor-unit combinations cannot contain RXYQ* units.
- 6) RXYQ8~20 "Non-continuous heating" multi-outdoor-unit combinations cannot contain RYM08~20 units.
- 7) Multi "non-continuous heating" replacement models only consist of RXYQ8~20 modules (e.g. RXYQ36*+RXYQ16*+RXYQ20*).
- 8) Replacement units cannot be combined with other units.
- 9) T-series outdoor units and U-series outdoor units cannot share the same refrigerant circuit. When combining these units, make sure they are part of separate refrigerant circuits.

3D120060

RYYQ8-20U
RYMQ8-20U
RXYQ8-20U

Compatibility list: ·VRV4· heat pump - ·RA DX· indoor unit

Wall mounted type	Emura	FTXJ20M FTXJ25M FTXJ35M FTXJ50M
	Stylish	FTXA20 FTXA25 FTXA35 FTXA42 FTXA50
Ceiling/wall mounted	Flex	FLXS25B FLXS35B FLXS50B FLXS60B
Floor standing type	FVXM	FVXM25F FVXM35F FVXM50F
	Nexura	FVXG25K FVXG35K FVXG50K

Remark

- The limitations on the use of ·RA DX· indoor units with the ·VRV4· Heat Pump are subject to the rules set out in drawings ·3D079543· and ·3D079540·.
- If you want to connect ·RA·/·SA· ·DX· cassette, ceiling-mounted, or duct indoor units, use their ·VRV DX· indoor unit equivalents instead.

3D082373D

4 Combination table

4 - 1 Combination Table

RXYQ-U
RYYQ-U
RYMQ-U

VRV4
Heat pump
Indoor unit combination restrictions
(1/2)

Indoor unit combination pattern	-VRV* DX- indoor unit	-RA DX- indoor unit	Hydrobox unit	Air handling unit (AHU) ⁽³⁾
-VRV* DX- indoor unit	O	O	O	O
-RA DX- indoor unit	O	O	X	X
Hydrobox unit	O	X	O ₁	X
Air handling unit ⁽³⁾	O	X	X	O ₂

O: Allowed
X: Not allowed

Notes

1. -VRV* DX- indoor unit

- When combining -VRV DX- indoor units with other types of indoor units, respect the following combination patterns:

Example

Allowed : (-VRV DX- indoor unit + Hydrobox- unit) or (-VRV DX- indoor unit + -RA DX- indoor unit) or (-VRV DX- indoor unit + -AHU-)

Not allowed : [-VRV DX- indoor unit + (-RA DX- indoor unit & (-Hydrobox- unit or -AHU-))] or [-VRV DX- indoor unit + (Hydrobox- unit & (-RA DX- indoor unit or -AHU-))]

2. O₁

- Only connect -Hydrobox- units to a -VRV IV- Heat Pump in combination with a -VRV DX- indoor unit.

→ Refer to the connection ratio restrictions (3D079540 & 3D117169-).

→ Connection with only Hydrobox units: refer to the Daikin Altherma solutions.

- Only connect -Hydrobox- units of the -HX* - series.

→ -HXHD* - series -Hydrobox- units are not allowed.

3. O₂

- Combination of -AHU- only + control box -EKEQFA- (the combination with -VRV DX- indoor units is not allowed; maximum -54-HP for -400 + 2x500- class -EKE XV- kit)
→ -X- control is possible (up to -3x- [-EKE XV+EKEQFA* - boxes] can be connected to one outdoor unit (system)). No Variable Refrigerant Temperature control possible.
→ -Y- control is possible (up to -3x- [-EKE XV+EKEQFA* - boxes] can be connected to one outdoor unit (system)). No Variable Refrigerant Temperature control possible.
→ -W- control is possible (up to -3x- [-EKE XV+EKEQFA* - boxes] can be connected to one outdoor unit (system)). No Variable Refrigerant Temperature control possible.

- Combination of -AHU- only + control box -EKEQMA- (not combined with -VRV DX- indoor units)

→ Z-control is possible (the allowed number of [-EKE XV + EKEQMA- boxes] is determined by the connection ratio (90-110%) and the capacity of the outdoor unit.

4. Combination of -AHU- and -VRV DX- indoor units

→ Z-control is possible (-EKEQMA* - boxes are allowed, but with a limited connection ratio).

5. The combination of -AHU- with -Hydrobox- units or -RA DX- indoor units is not allowed.

6. (3) The following units are considered AHUs:

- -EKE XV + EKEQ(MA/FA) + AHU- coil
- -Biddle- air curtain
- -FXMQ_MF- units

Information

- -VKM- units are considered to be regular -VRV DX- indoor units.

3D079543F

RXYQ-U
RYYQ-U
RYMQ-U

VRV4
Heat pump
Indoor unit combination restrictions
(2/2)

Combination table	RYYQ*	RYYQ*	RXYQ* RXMLQ* RXYLQ*	RXYQ* RXMLQ* RXYLQ*
	Single continuous heating	Multi continuous heating	Single non-continuous heating	Multi non-continuous heating
-VRV* DX- indoor unit	O	O	O	O
-RA DX- indoor unit	O	X	O	X
Hydrobox unit	O	O ₁	O	O ₁
Air handling unit (AHU) ⁽²⁾	O	O	O	O

O: Allowed
X: Not allowed

Notes

1. O₁

- Available upon request through the -SPN- procedure.

2. (2)

The following units are considered AHUs:

- -EKE XV + EKEQ(MA/FA) + AHU- coil
- -Biddle- air curtain
- -FXMQ_MF- units

3D079543F

4 Combination table

4 - 1 Combination Table

4

REMQ5U
 REYQ8-20U
 RXYQQ8-20U
 RXYTQ8-16UYF
 RYYQ8-20U
 RYMQ8-20U

Unit combination restrictions: VRV4 outdoor units (all models) + 15-class indoor units

Units in scope: FXZQ15A and FXAQ15A.

1. In case the system contains these indoor units and the total connection ratio (CR) $\leq 100\%$: no special restrictions. Follow the restrictions that apply to regular VRV DX indoor units.
2. In case the system contains these indoor units and the total connection ratio (CR) $> 100\%$: special restrictions apply.
 - A. When the connection ratio (CR1) of the sum of all FXZQ15A and/or FXAQ15A units in the system $\leq 70\%$, and ALL other VRV DX indoor units have an individual capacity class > 50 : no special restrictions.
 - B. When the connection ratio (CR1) of the sum of all FXZQ15A and/or FXAQ15A units in the system $\leq 70\%$, and NOT ALL other VRV DX indoor units have an individual capacity class > 50 : the restrictions below apply.
 - $100\% < CR \leq 105\% \rightarrow$ CR1 of the sum of all FXZQ15A and/or FXAQ15A indoor units in the system must be $\leq 70\%$.
 - $105\% < CR \leq 110\% \rightarrow$ CR1 of the sum of all FXZQ15A and/or FXAQ15A indoor units in the system must be $\leq 60\%$.
 - $110\% < CR \leq 115\% \rightarrow$ CR1 of the sum of all FXZQ15A and/or FXAQ15A indoor units in the system must be $\leq 40\%$.
 - $115\% < CR \leq 120\% \rightarrow$ CR1 of the sum of all FXZQ15A and/or FXAQ15A indoor units in the system must be $\leq 25\%$.
 - $120\% < CR \leq 125\% \rightarrow$ CR1 of the sum of all FXZQ15A and/or FXAQ15A indoor units in the system must be $\leq 10\%$.
 - $125\% < CR \leq 130\% \rightarrow$ FXZQ15A and FXAQ15A cannot be used

REMARK

Only the 15-class indoor units explicitly mentioned on this page are in scope. Other indoor units follow the rules that apply to regular VRV DX indoor units.

3D104665

5 Capacity tables

5 - 1 Capacity Table Legend

In order to fulfill more your requirements on quick access of data in the format you require, we have developed a tool to consult capacity tables.

Below you can find the link to the capacity table database and an overview of all the tools we have to help you select the correct product:

- Capacity table database: lets you find back and export quickly the capacity information you are looking for based upon unit model, refrigerant temperature and connection ratio.

[Click here to access the capacity table viewer.](#)



- For more information about all our tools we offer [click here to see the overview](#) on my.daikin.eu



5 Capacity tables

5 - 2 Capacity Correction Factor

RXYQQ-U
RXYQ-U
RYYQ-U
RYMQ-U

VRV4 Heat pump Integrated heating capacity coefficient

The heating capacity tables do not take into account the capacity reduction in case of frost accumulation or defrost operation. The capacity values that take these factors into account, or in other words, the integrated heating capacity values, can be calculated as follows:

Formula
A = Integrated heating capacity
B = Capacity characteristics value (see table)
C = Integrated correction factor for frost accumulation (see table)
A = B * C

Inlet air temperature of heat exchanger

[°CDB/°CWB]	-7/-7,6 or less	-5/-5,6	-3/-3,7	0/-0,7	3/2,2	5/4,1	7/6
Integrated correction factor for frost accumulation C							
8HP	0,95	0,93	0,88	0,84	0,85	0,90	1,00
10HP	0,95	0,93	0,87	0,79	0,80	0,88	1,00
12HP	0,95	0,92	0,87	0,75	0,76	0,85	1,00
14HP	0,95	0,92	0,86	0,72	0,73	0,84	1,00
16HP	0,95	0,92	0,86	0,72	0,72	0,83	1,00
18HP	0,95	0,93	0,88	0,84	0,85	0,90	1,00
20HP	0,95	0,93	0,88	0,84	0,85	0,90	1,00
22HP	0,95	0,92	0,87	0,77	0,78	0,86	1,00
24HP	0,95	0,92	0,87	0,75	0,76	0,85	1,00
26HP	0,95	0,92	0,86	0,73	0,74	0,84	1,00
28HP	0,95	0,92	0,86	0,73	0,74	0,84	1,00
30HP	0,95	0,93	0,87	0,80	0,81	0,88	1,00
32HP	0,95	0,92	0,86	0,71	0,72	0,83	1,00
34HP	0,95	0,92	0,87	0,78	0,79	0,87	1,00
36HP	0,95	0,92	0,87	0,78	0,79	0,87	1,00
38HP	0,95	0,93	0,88	0,83	0,84	0,89	1,00
40HP	0,95	0,93	0,87	0,80	0,81	0,88	1,00
42HP	0,95	0,92	0,86	0,73	0,74	0,84	1,00
44HP	0,95	0,92	0,86	0,72	0,73	0,84	1,00
46HP	0,95	0,92	0,86	0,72	0,72	0,83	1,00
48HP	0,95	0,92	0,86	0,71	0,72	0,83	1,00
50HP	0,95	0,92	0,87	0,76	0,77	0,86	1,00
52HP	0,95	0,93	0,87	0,80	0,81	0,88	1,00
54HP	0,95	0,93	0,88	0,84	0,85	0,90	1,00

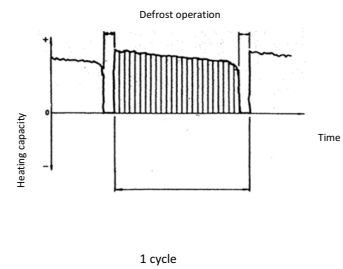

Notes

The figure shows the integrated heating capacity for a single cycle (from one defrost operation to the next).

When there is an accumulation of snow against the outdoor unit heat exchanger, there will always be a temporary reduction in capacity depending on the outdoor temperature (°C DB), relative humidity (RH) and the amount of frosting which occurs.

The multi-combination data 22°54HP corresponds with the standard multi-combination of drawing 3D079534.

3D079898A

5 Capacity tables

5 - 2 Capacity Correction Factor

RXYQQ8U
RXYQ8U
RYYQ8U
RYMQ8U

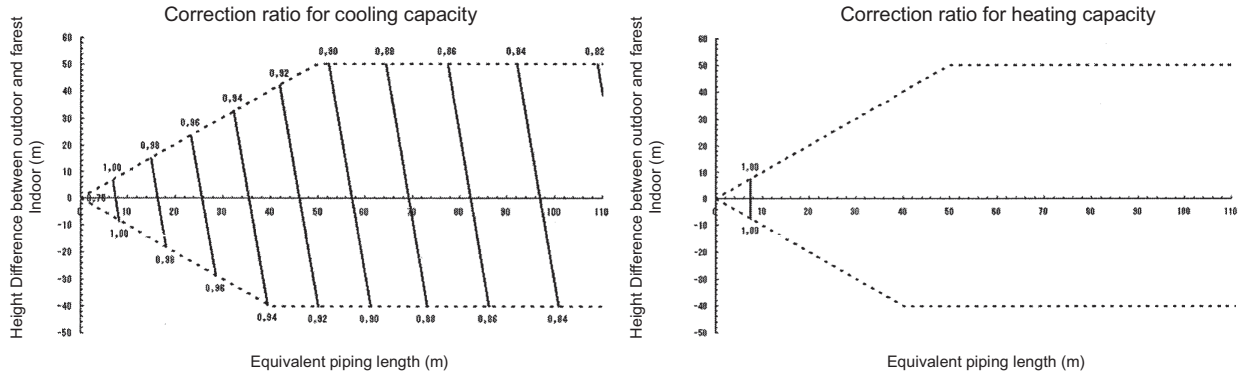

NOTES

- These figures illustrate the correction ratio for piping length in capacity for a standard indoor unit system at maximum load (with the thermostat set to maximum) under standard conditions. Moreover, under partial load conditions, there is only a minor deviation for the capacity correction ratio, shown in the above figures.
- With this outdoor unit, constant evaporating pressure control when cooling and constant condensing pressure control when heating is carried out.
- Method of calculating the capacity of the outdoor units
The maximum capacity of the system will be either the total capacity of the indoor units or the maximum capacity of the outdoor units as mentioned below, whichever is smaller.

Condition: Indoor connection ratio does not exceed 100%.

$$\text{Maximum capacity of outdoor units} = \text{Capacity of outdoor units from capacity table at the 100\% connection ratio} \times \text{Correction ratio of piping to furthest indoor}$$

Condition: Indoor connection ratio exceeds 100%.

$$\text{Maximum capacity of outdoor units} = \text{Capacity of outdoor units from capacity table at installed connection ratio} \times \text{Correction ratio of piping to furthest indoor}$$

- When level difference is 50 m or more (see installation manual and 3D079540 / 3D079543) and equivalent pipe length is 90 m or more, the diameter of the main gas and liquid pipes (outdoor unit - branch sections) must be increased. For new diameters, see below.

Model	Gas	Liquid
8HP	22.2	12.7

- When the pipe length after the first refrigerant branch kit is more than 40 m, pipe size between first and final branch kit must be increased (only for VRV DX indoor units; details see installation manual).
*Refer to the installation manual for allowed system setups and rules for dedicated indoor connection types.

Diameter of main pipes (standard size)

Model	Gas	Liquid
8HP	19.1	9.5

- Equivalent length used in the above figures is based upon the following equivalent length

$$\text{Equivalent piping length} = \text{Equivalent length of main pipe} \times \text{Correction factor} + \text{Equivalent length of branch pipes}$$

Choose the correction factor from the following table. When cooling capacity is calculated: gas pipe size. When heating capacity is calculated: liquid pipe size

	Correction factor	
	Standard size	Size increase
Cooling (gas pipe)	1.0	0.5
Heating (liquid pipe)	1.0	0.5

Example

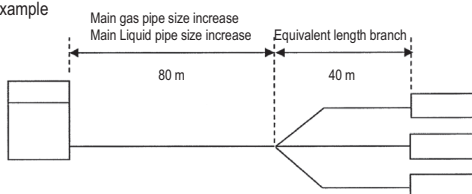

In the above case (Cooling) Overall equivalent length = 80 m x 0.5 + 40 m = 80 m
(Heating) Overall equivalent length = 80 m x 0.5 + 40 m = 80 m
The rate of change in cooling capacity when height difference = 0 is thus approximately 0.86
heating capacity when height difference = 0 is thus approximately 1.0

3D079897A

5 Capacity tables

5 - 2 Capacity Correction Factor

5

RXYQQ10U
RXYQ10U
RYYQ10U
RYMQ10U

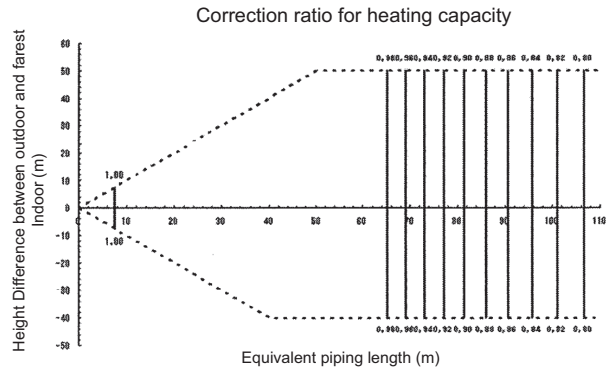
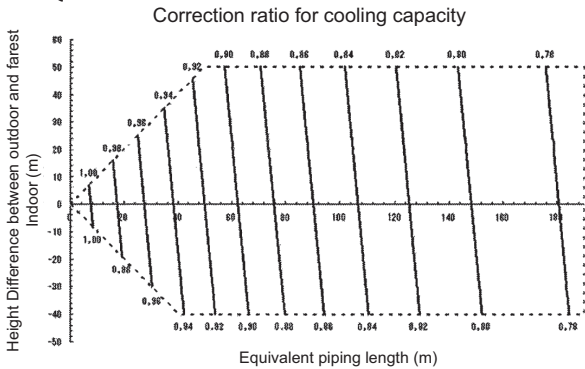

NOTES

- These figures illustrate the correction ratio for piping length in capacity for a standard indoor unit system at maximum load (with the thermostat set to maximum) under standard conditions. Moreover, under partial load conditions, there is only a minor deviation for the capacity correction ratio, shown in the above figures.
- With this outdoor unit, constant evaporating pressure control when cooling and constant condensing pressure control when heating is carried out.
- Method of calculating the capacity of the outdoor units
The maximum capacity of the system will be either the total capacity of the indoor units or the maximum capacity of the outdoor units as mentioned below, whichever is smaller.

Condition: Indoor connection ratio does not exceed 100%.

$$\text{Maximum capacity of outdoor units} = \text{Capacity of outdoor units from capacity table at the 100\% connection ratio} \times \text{Correction ratio of piping to furthest indoor}$$

Condition: Indoor connection ratio exceeds 100%.

$$\text{Maximum capacity of outdoor units} = \text{Capacity of outdoor units from capacity table at installed connection ratio} \times \text{Correction ratio of piping to furthest indoor}$$

- When level difference is 50 m or more (see installation manual and 3D079540 / 3D079543) and equivalent pipe length is 90 m or more, the diameter of the main gas and liquid pipes (outdoor unit - branch sections) must be increased. For new diameters, see below.

Model	Gas	Liquid
RXYQ10P	25.4*	12.7

*If not available on site, do not increase. If not increased correction factor should be applied to the equivalent length (see note 6).

- When the pipe length after the first refrigerant branch kit is more than 40 m, pipe size between first and final branch kit must be increased (only for VRV DX indoor units; details see installation manual).

*Refer to the installation manual for allowed system setups and rules for dedicated indoor connection types.

Diameter of main pipes (standard size)

Model	Gas	Liquid
10 HP	22.2	9.5

- Equivalent length used in the above figures is based upon the following equivalent length

$$\text{Equivalent piping length} = \text{Equivalent length of main pipe} \times \text{Correction factor} + \text{Equivalent length of branch pipes}$$

Choose the correction factor from the following table. When cooling capacity is calculated: gas pipe size When heating capacity is calculated: liquid pipe size

	Correction factor	
	Standard size	Size increase
Cooling (gas pipe)	1.0	0.5
Heating (liquid pipe)	1.0	0.5

Example

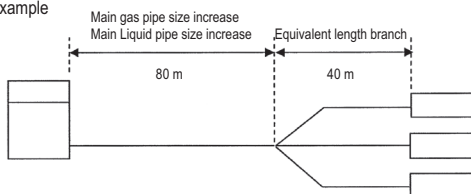

In the above case (Cooling) Overall equivalent length = 80 m x 0.5 + 40 m = 80 m
(Heating) Overall equivalent length = 80 m x 0.5 + 40 m = 80 m

The rate of change in cooling capacity when height difference = 0 is thus approximately 0.87
heating capacity when height difference = 0 is thus approximately 0.90

3D079897A

5 Capacity tables

5 - 2 Capacity Correction Factor

RXYQQ12,14,16,24,36U

RXYQ12,14,24,36U

RYYQ12,14,24,36U

RYMQ12,14U

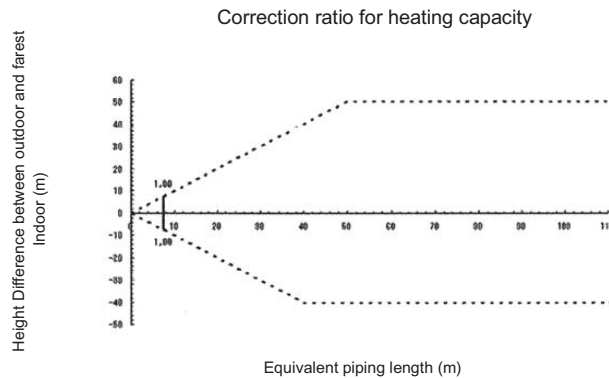
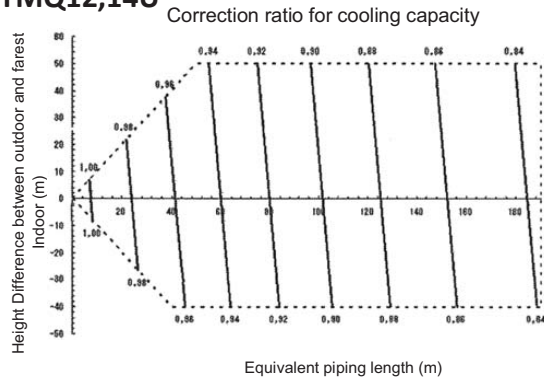

NOTES

- These figures illustrate the correction ratio for piping length in capacity for a standard indoor unit system at maximum load (with the thermostat set to maximum) under standard conditions. Moreover, under partial load conditions, there is only a minor deviation for the capacity correction ratio, shown in the above figures.
- With this outdoor unit, constant evaporating pressure control when cooling and constant condensing pressure control when heating is carried out.
- Method of calculating the capacity of the outdoor units
The maximum capacity of the system will be either the total capacity of the indoor units or the maximum capacity of the outdoor units as mentioned below, whichever is smaller.

Condition: Indoor connection ratio does not exceed 100%.

$$\text{Maximum capacity of outdoor units} = \text{Capacity of outdoor units from capacity table at the 100\% connection ratio} \times \text{Correction ratio of piping to furthest indoor}$$

Condition: Indoor connection ratio exceeds 100%.

$$\text{Maximum capacity of outdoor units} = \text{Capacity of outdoor units from capacity table at installed connection ratio} \times \text{Correction ratio of piping to furthest indoor}$$

- When level difference is 50 m or more (see installation manual and 3D079540 / 3D079543) and equivalent pipe length is 90 m or more, the diameter of the main gas and liquid pipes (outdoor unit - branch sections) must be increased. For new diameters, see below.

Model	Gas	Liquid
12 HP	28.6	15.9
14 HP	28.6	15.9
24 HP	34.9	19.1
36 HP	41.3	22.2

- When the pipe length after the first refrigerant branch kit is more than 40 m, pipe size between first and final branch kit must be increased (only for VRV DX indoor units; details see installation manual).
*Refer to the installation manual for allowed system setups and rules for dedicated indoor connection types.

Diameter of main pipes (standard size)

Model	Gas	Liquid
12 HP	28.6	12.7
14 HP	28.6	12.7
24 HP	34.9	15.9
36 HP	41.3	19.1

- Equivalent length used in the above figures is based upon the following equivalent length

$$\text{Equivalent piping length} = \text{Equivalent length of main pipe} \times \text{Correction factor} + \text{Equivalent length of branch pipes}$$

Choose a correction factor from the following table. When cooling capacity is calculated: gas pipe size. When heating capacity is calculated: liquid pipe size

	Correction factor	
	Standard size	Size increase
Cooling (gas pipe)	1,0	1,0
Heating (liquid pipe)	1,0	0,5

Example

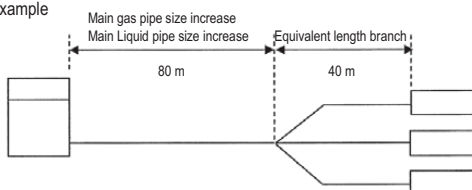

In the above case (Cooling) Overall equivalent length = 80 m x 1.0 + 40 m = 120 m
(Heating) Overall equivalent length = 80 m x 0.5 + 40 m = 80 m
The rate of change in cooling capacity when height difference = 0 is thus approximately 0.89
heating capacity when height difference = 0 is thus approximately 1.0

3D079897A

5 Capacity tables

5 - 2 Capacity Correction Factor

5

RXYQQ16U
RXYQ16U
RYYQ16U
RYMQ16U

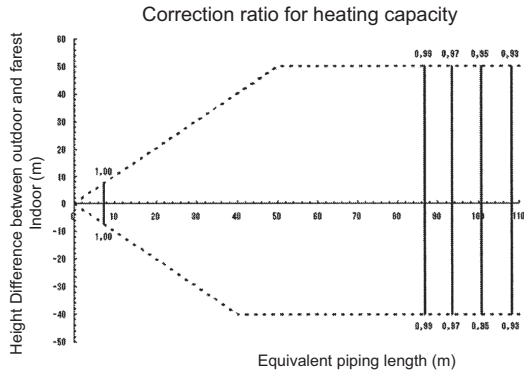
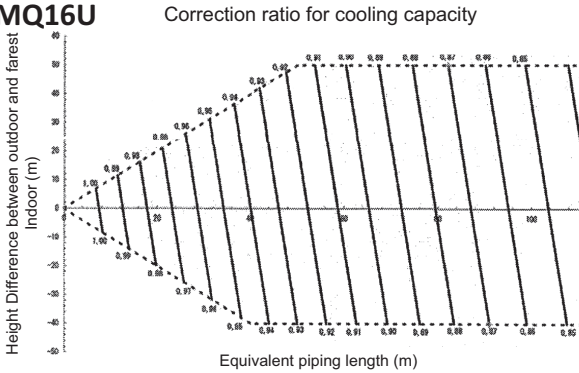

NOTES

- These figures illustrate the correction ratio for piping length in capacity for a standard indoor unit system at maximum load (with the thermostat set to maximum) under standard conditions. Moreover, under partial load conditions, there is only a minor deviation for the capacity correction ratio, shown in the above figures.
- With this outdoor unit, constant evaporating pressure control when cooling and constant condensing pressure control when heating is carried out.
- Method of calculating the capacity of the outdoor units
The maximum capacity of the system will be either the total capacity of the indoor units or the maximum capacity of the outdoor units as mentioned below, whichever is smaller.

Condition: Indoor connection ratio does not exceed 100%.

$$\text{Maximum capacity of outdoor units} = \text{Capacity of outdoor units from capacity table at the 100\% connection ratio} \times \text{Correction ratio of piping to furthest indoor}$$

Condition: Indoor connection ratio exceeds 100%.

$$\text{Maximum capacity of outdoor units} = \text{Capacity of outdoor units from capacity table at installed connection ratio} \times \text{Correction ratio of piping to furthest indoor}$$

- When level difference is 50 m or more (see installation manual and 3D079540 / 3D079543) and equivalent pipe length is 90 m or more, the diameter of the main gas and liquid pipes (outdoor unit - branch sections) must be increased. For new diameters, see below.

Model	Gas	Liquid
16 HP	31.8*	15.9

*If not available on site, do not increase. If not increased correction factor should be applied to the equivalent length (see note 6).

- When the pipe length after the first refrigerant branch kit is more than 40 m, pipe size between first and final branch kit must be increased (only for VRV DX indoor units; details see installation manual).
*Refer to the installation manual for allowed system setups and rules for dedicated indoor connection types.

Diameter of main pipes (standard size)

Model	Gas	Liquid
16 HP	28.6	12.7

- Equivalent length used in the above figures is based upon the following equivalent length

$$\text{Equivalent piping length} = \text{Equivalent length of main pipe} \times \text{Correction factor} + \text{Equivalent length of branch pipes}$$

Choose a correction factor from the following table. When cooling capacity is calculated: gas pipe size When heating capacity is calculated: liquid pipe size

	Correction factor	
	Standard size	Size increase
Cooling (gas pipe)	1.0	0.5
Heating (liquid pipe)	1.0	0.5

Example

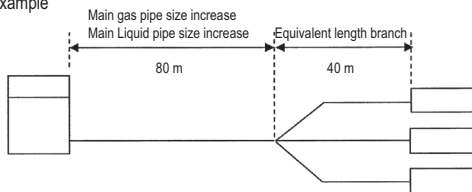

In the above case (Cooling) Overall equivalent length = 80 m x 1.0 + 40 m = 80 m
(Heating) Overall equivalent length = 80 m x 0.5 + 40 m = 80 m
The rate of change in cooling capacity when height difference = 0 is thus approximately 0.88
heating capacity when height difference = 0 is thus approximately 0.99

3D079897A

5 Capacity tables

5 - 2 Capacity Correction Factor

RXYQQ18,26,28,30,38,42,44U
 RXYQ18,26,28,30,38,42,44U
 RYYQ18,26,28,30,38,42,44U
 RYMQ18U

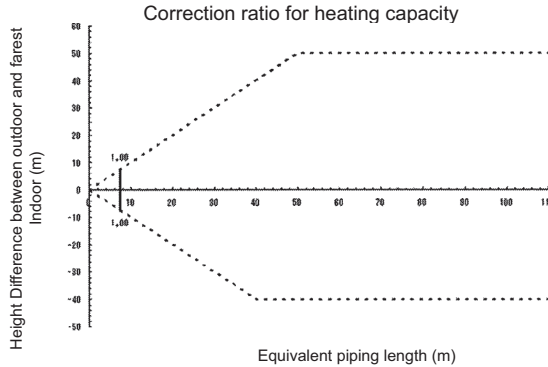
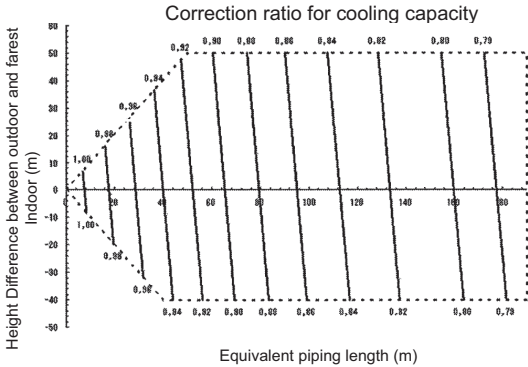

NOTES

- These figures illustrate the correction ratio for piping length in capacity for a standard indoor unit system at maximum load (with the thermostat set to maximum) under standard conditions. Moreover, under partial load conditions, there is only a minor deviation for the capacity correction ratio, shown in the above figures.
- With this outdoor unit, constant evaporating pressure control when cooling and constant condensing pressure control when heating is carried out.
- Method of calculating the capacity of the outdoor units
 The maximum capacity of the system will be either the total capacity of the indoor units or the maximum capacity of the outdoor units as mentioned below, whichever is smaller.

Condition: Indoor connection ratio does not exceed 100%.

$$\text{Maximum capacity of outdoor units} = \text{Capacity of outdoor units from capacity table at the 100\% connection ratio} \times \text{Correction ratio of piping to furthest indoor}$$

Condition: Indoor connection ratio exceeds 100%.

$$\text{Maximum capacity of outdoor units} = \text{Capacity of outdoor units from capacity table at installed connection ratio} \times \text{Correction ratio of piping to furthest indoor}$$

- When level difference is 50 m or more (see installation manual and 3D079540 / 3D079543) and equivalent pipe length is 90 m or more, the diameter of the main gas and liquid pipes (outdoor unit - branch sections) must be increased. For new diameters, see below.

Model	Gas	Liquid
18 HP	31.8*	19.1
26-30 HP	38.1*	22.2
38-44 HP	41.3	22.2

*If not available on site, do not increase. If not increased correction factor should be applied to the equivalent length (see note 6).

- When the pipe length after the first refrigerant branch kit is more than 40 m, pipe size between first and final branch kit must be increased (only for VRV DX indoor units; details see installation manual).

*Refer to the installation manual for allowed system setups and rules for dedicated indoor connection types.

Diameter of main pipes (standard size)

Model	Gas	Liquid
18 HP	28.6	15.9
26-30 HP	34.9	19.1
38-44 HP	41.3	19.1

- Equivalent length used in the above figures is based upon the following equivalent length

$$\text{Equivalent piping length} = \text{Equivalent length of main pipe} \times \text{Correction factor} + \text{Equivalent length of branch pipes}$$

Choose the correction factor from the following table. When cooling capacity is calculated: gas pipe size. When heating capacity is calculated: liquid pipe size

	Correction factor	
	Standard size	Size increase
Cooling (gas pipe)	1.0	0.5
Heating (liquid pipe)	1.0	0.5

Example

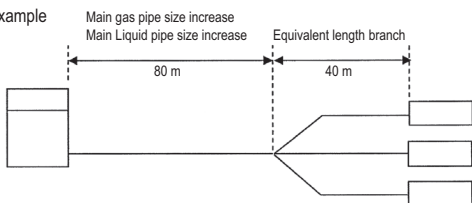

In the above case (for RXYQ38-44) (Cooling) Overall equivalent length = 80 m x 1.0 + 40 m = 120 m
 (Heating) Overall equivalent length = 80 m x 0.5 + 40 m = 80 m
 The rate of change in cooling capacity when height difference = 0 is thus approximately 0.83
 heating capacity when height difference = 0 is thus approximately 1.0

3D079897A

5 Capacity tables

5 - 2 Capacity Correction Factor

5

RXYQQ20,32,34U
 RXYQ20,32,34U
 RYYQ20,32,34U
 RYM20,32,34U

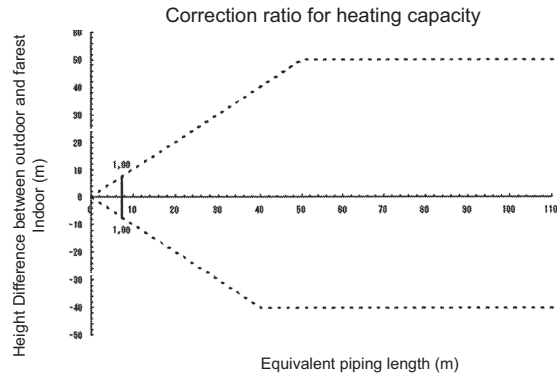
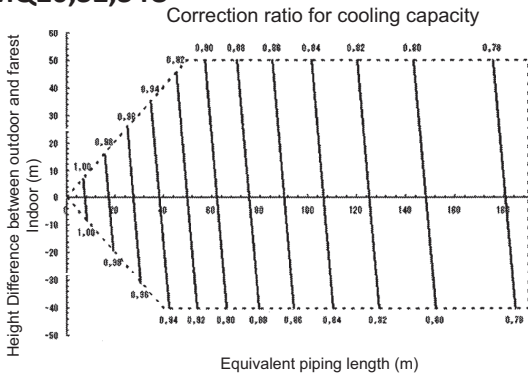

NOTES

- These figures illustrate the correction ratio for piping length in capacity for a standard indoor unit system at maximum load (with the thermostat set to maximum) under standard conditions. Moreover, under partial load conditions, there is only a minor deviation for the capacity correction ratio, shown in the above figures.
- With this outdoor unit, constant evaporating pressure control when cooling and constant condensing pressure control when heating is carried out.
- Method of calculating the capacity of the outdoor units
 The maximum capacity of the system will be either the total capacity of the indoor units or the maximum capacity of the outdoor units as mentioned below, whichever is smaller.

Condition: Indoor connection ratio does not exceed 100%.

$$\text{Maximum capacity of outdoor units} = \text{Capacity of outdoor units from capacity table at the 100\% connection ratio} \times \text{Correction ratio of piping to furthest indoor}$$

Condition: Indoor connection ratio exceeds 100%.

$$\text{Maximum capacity of outdoor units} = \text{Capacity of outdoor units from capacity table at installed connection ratio} \times \text{Correction ratio of piping to furthest indoor}$$

- When level difference is 50 m or more (see installation manual and 3D079540 / 3D079543) and equivalent pipe length is 90 m or more, the diameter of the main gas and liquid pipes (outdoor unit - branch sections) must be increased. For new diameters, see below.

Model	Gas	Liquid
20 HP	31.8*	19.1
32/34 HP	38.1*	22.2

*If not available on site, do not increase. If not increased correction factor should be applied to the equivalent length (see note 6).

- When the pipe length after the first refrigerant branch kit is more than 40 m, pipe size between first and final branch kit must be increased (only for VRV DX indoor units; details see installation manual).

*Refer to the installation manual for allowed system setups and rules for dedicated indoor connection types.

Diameter of main pipes (standard size)

Model	Gas	Liquid
20 HP	28.6	15.9
32/34 HP	34.9	19.1

- Equivalent length used in the above figures is based upon the following equivalent length

$$\text{Equivalent piping length} = \text{Equivalent length of main pipe} \times \text{Correction factor} + \text{Equivalent length of branch pipes}$$

Choose a correction factor from the following table. When cooling capacity is calculated: gas pipe size When heating capacity is calculated: liquid pipe size

	Correction factor	
	Standard size	Size increase
Cooling (gas pipe)	1.0	0.5
Heating (liquid pipe)	1.0	0.5

Example

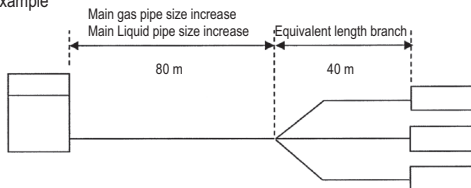

In the above case (Cooling) Overall equivalent length = 80 m x 0.5 + 40 m = 80 m
 (Heating) Overall equivalent length = 80 m x 0.5 + 40 m = 80 m

The rate of change in cooling capacity when height difference = 0 is thus approximately 0.88
 heating capacity when height difference = 0 is thus approximately 1.0

3D079897A

5 Capacity tables

5 - 2 Capacity Correction Factor

RXYQQ22U
RXYQ22U
RYYQ22U
RYMQ22U

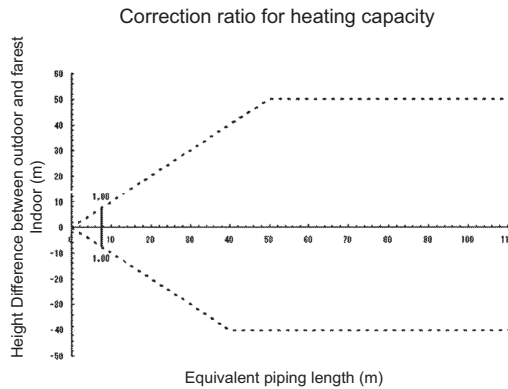
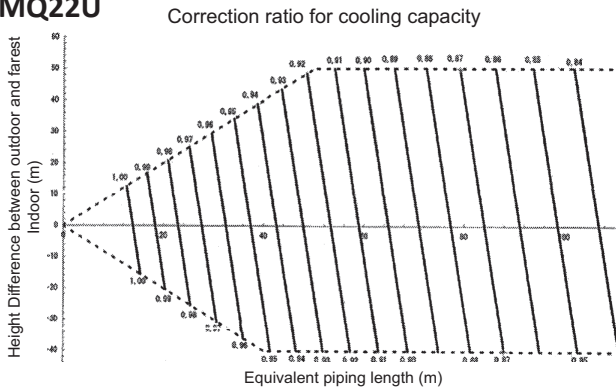

NOTES

- These figures illustrate the correction ratio for piping length in capacity for a standard indoor unit system at maximum load (with the thermostat set to maximum) under standard conditions. Moreover, under partial load conditions, there is only a minor deviation for the capacity correction ratio, shown in the above figures.
- With this outdoor unit, constant evaporating pressure control when cooling and constant condensing pressure control when heating is carried out.
- Method of calculating the capacity of the outdoor units
The maximum capacity of the system will be either the total capacity of the indoor units or the maximum capacity of the outdoor units as mentioned below, whichever is smaller.

Condition: Indoor connection ratio does not exceed 100%.

$$\text{Maximum capacity of outdoor units} = \text{Capacity of outdoor units from capacity table at the 100\% connection ratio} \times \text{Correction ratio of piping to furthest indoor}$$

Condition: Indoor connection ratio exceeds 100%.

$$\text{Maximum capacity of outdoor units} = \text{Capacity of outdoor units from capacity table at installed connection ratio} \times \text{Correction ratio of piping to furthest indoor}$$

- When level difference is 50 m or more (see installation manual and 3D079540 / 3D079543) and equivalent pipe length is 90 m or more, the diameter of the main gas and liquid pipes (outdoor unit - branch sections) must be increased. For new diameters, see below.

Model	Gas	Liquid
22 HP	31.8*	19.1

* If not available on site, do not increase, if not increased, no correction factor should be applied to the equivalent length (see note 6).

- When the pipe length after the first refrigerant branch kit is more than 40 m, pipe size between first and final branch kit must be increased (only for VRV DX indoor units; details see installation manual).

*Refer to the installation manual for allowed system setups and rules for dedicated indoor connection types.

Diameter of main pipes (standard size)

Model	Gas	Liquid
22 HP	28.6	15.9

- Equivalent length used in the above figures is based upon the following equivalent length

$$\text{Overall equivalent length} = \text{Equivalent length of main pipe} \times \text{Correction factor} + \text{Equivalent length of branch pipes}$$

Choose a correction factor from the following table. When cooling capacity is calculated: gas pipe size When heating capacity is calculated: liquid pipe size

	Correction factor	
	Standard size	Size increase
Cooling (gas pipe)	1.0	0.5
Heating (liquid pipe)	1.0	0.5

Example

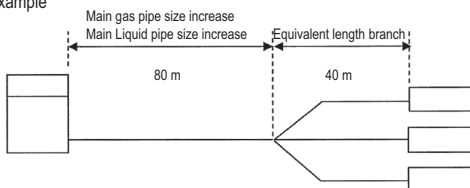

In the above case (Cooling) Overall equivalent length = 80 m x 0.5 + 40 m = 80 m
(Heating) Overall equivalent length = 80 m x 0.5 + 40 m = 80 m

The rate of change in cooling capacity when height difference = 0 is thus approximately 0.88
heating capacity when height difference = 0 is thus approximately 1.0

5 Capacity tables

5 - 2 Capacity Correction Factor

5

RYYQ46U RXYQ46U

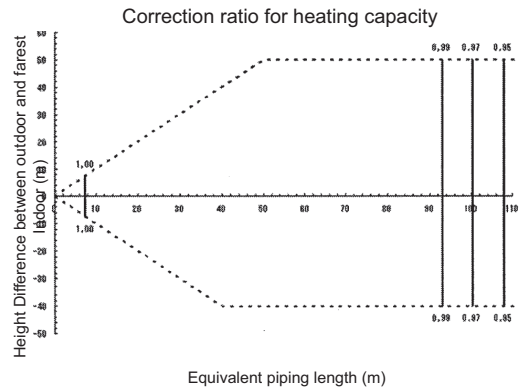
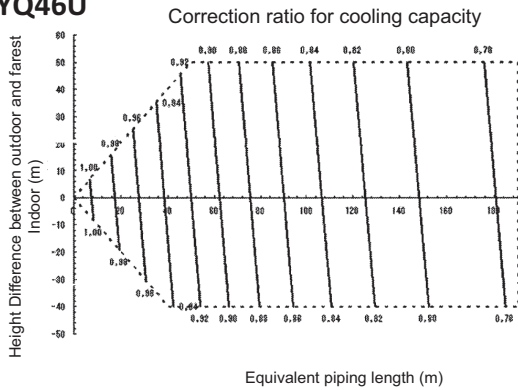

NOTES

- These figures illustrate the correction ratio for piping length in capacity for a standard indoor unit system at maximum load (with the thermostat set to maximum) under standard conditions. Moreover, under partial load conditions, there is only a minor deviation for the capacity correction ratio, shown in the above figures.
- With this outdoor unit, constant evaporating pressure control when cooling and constant condensing pressure control when heating is carried out.
- Method of calculating the capacity of the outdoor units
The maximum capacity of the system will be either the total capacity of the indoor units or the maximum capacity of the outdoor units as mentioned below, whichever is smaller.

Condition: Indoor connection ratio does not exceed 100%.

$$\text{Maximum capacity of outdoor units} = \text{Capacity of outdoor units from capacity table at the 100\% connection ratio} \times \text{Correction ratio of piping to furthest indoor}$$

Condition: Indoor connection ratio exceeds 100%.

$$\text{Maximum capacity of outdoor units} = \text{Capacity of outdoor units from capacity table at installed connection ratio} \times \text{Correction ratio of piping to furthest indoor}$$

- When level difference is 50 m or more (see installation manual and 3D079540 / 3D079543) and equivalent pipe length is 90 m or more, the diameter of the main gas and liquid pipes (outdoor unit - branch sections) must be increased. For new diameters, see below.

Model	Gas	Liquid
46 HP	41.3	22.2

- When the pipe length after the first refrigerant branch kit is more than 40 m, pipe size between first and final branch kit must be increased (only for VRV DX indoor units; details see installation manual).

*Refer to the installation manual for allowed system setups and rules for dedicated indoor connection types.

Diameter of main pipes (standard size)

Model	Gas	Liquid
46 HP	41.3	19.1

- Equivalent length used in the above figures is based upon the following equivalent length

$$\text{Equivalent piping length} = \text{Equivalent length of main pipe} \times \text{Correction factor} + \text{Equivalent length of branch pipes}$$

Choose a correction factor from the following table. When cooling capacity is calculated: gas pipe size When heating capacity is calculated: liquid pipe size

	Correction factor	
	Standard size	Size increase
Cooling (gas pipe)	1.0	0.5
Heating (liquid pipe)	1.0	0.5

Example

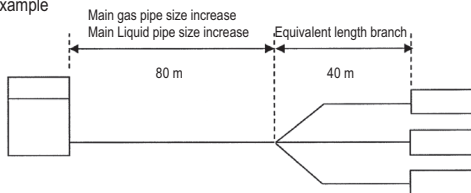

In the above case (Cooling) Overall equivalent length = 80 m x 1.0 + 40 m = 120 m
(Heating) Overall equivalent length = 80 m x 0.5 + 40 m = 80 m
The rate of change in cooling capacity when height difference = 0 is thus approximately 0.83
heating capacity when height difference = 0 is thus approximately 1.0

5 Capacity tables

5 - 2 Capacity Correction Factor

RYYQ48U
RXYQ48U
RXYQ48U

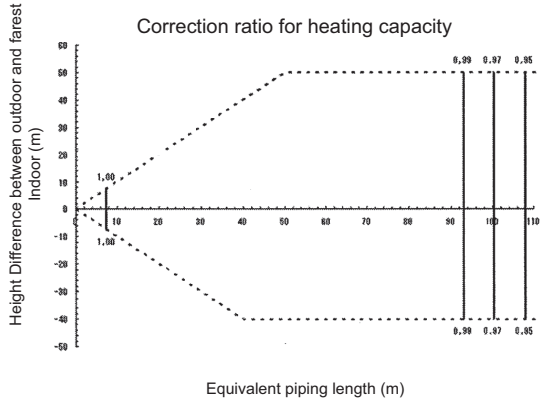
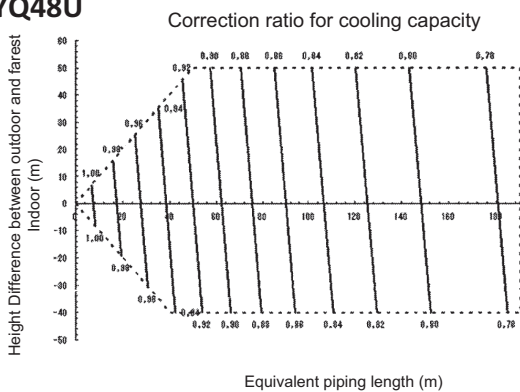

NOTES

- These figures illustrate the correction ratio for piping length in capacity for a standard indoor unit system at maximum load (with the thermostat set to maximum) under standard conditions. Moreover, under partial load conditions, there is only a minor deviation for the capacity correction ratio, shown in the above figures.
- With this outdoor unit, constant evaporating pressure control when cooling and constant condensing pressure control when heating is carried out.
- Method of calculating the capacity of the outdoor units
The maximum capacity of the system will be either the total capacity of the indoor units or the maximum capacity of the outdoor units as mentioned below, whichever is smaller.

Condition: Indoor connection ratio does not exceed 100%.

$$\text{Maximum capacity of outdoor units} = \text{Capacity of outdoor units from capacity table at the 100\% connection ratio} \times \text{Correction ratio of piping to furthest indoor}$$

Condition: Indoor connection ratio exceeds 100%.

$$\text{Maximum capacity of outdoor units} = \text{Capacity of outdoor units from capacity table at installed connection ratio} \times \text{Correction ratio of piping to furthest indoor}$$

- When level difference is 50 m or more (see installation manual and 3D079540 / 3D079543) and equivalent pipe length is 90 m or more, the diameter of the main gas and liquid pipes (outdoor unit - branch sections) must be increased. For new diameters, see below.

Model	Gas	Liquid
48 HP	41.3	22.2

- When the pipe length after the first refrigerant branch kit is more than 40 m, pipe size between first and final branch kit must be increased (only for VRV DX indoor units; details see installation manual).

*Refer to the installation manual for allowed system setups and rules for dedicated indoor connection types.

Diameter of main pipes (standard size)

Model	Gas	Liquid
48 HP	41.3	19.1

- Equivalent length used in the above figures is based upon the following equivalent length

$$\text{Equivalent piping length} = \text{Equivalent length of main pipe} \times \text{Correction factor} + \text{Equivalent length of branch pipes}$$

Choose a correction factor from the following table. When cooling capacity is calculated: gas pipe size. When heating capacity is calculated: liquid pipe size

	Correction factor	
	Standard size	Size increase
Cooling (gas pipe)	1.0	0.5
Heating (liquid pipe)	1.0	0.5

Example

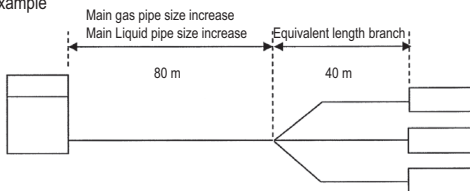

In the above case (Cooling) Overall equivalent length = 80 m x 1.0 + 40 m = 120 m
(Heating) Overall equivalent length = 80 m x 0.5 + 40 m = 80 m
The rate of change in cooling capacity when height difference = 0 is thus approximately 0.83
heating capacity when height difference = 0 is thus approximately 0.97

5 Capacity tables

5 - 2 Capacity Correction Factor

5

RYYQ50U
RXYQQ50U
RXYQ50U

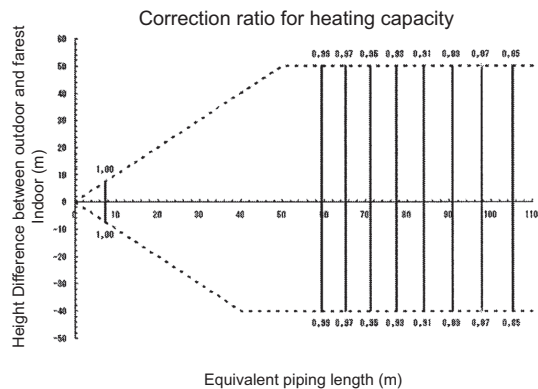
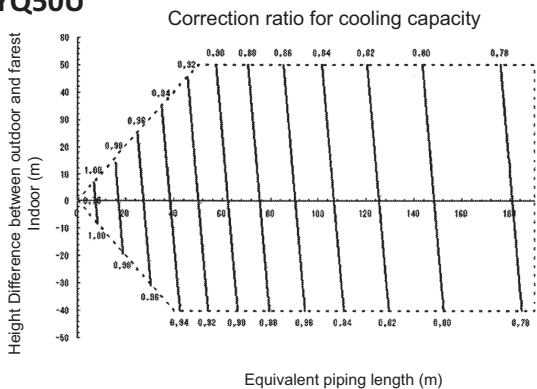

NOTES

- These figures illustrate the correction ratio for piping length in capacity for a standard indoor unit system at maximum load (with the thermostat set to maximum) under standard conditions. Moreover, under partial load conditions, there is only a minor deviation for the capacity correction ratio, shown in the above figures.
- With this outdoor unit, constant evaporating pressure control when cooling and constant condensing pressure control when heating is carried out.
- Method of calculating the capacity of the outdoor units
The maximum capacity of the system will be either the total capacity of the indoor units or the maximum capacity of the outdoor units as mentioned below, whichever is smaller.

Condition: Indoor connection ratio does not exceed 100%.

$$\text{Maximum capacity of outdoor units} = \text{Capacity of outdoor units from capacity table at the 100\% connection ratio} \times \text{Correction ratio of piping to furthest indoor}$$

Condition: Indoor connection ratio exceeds 100%.

$$\text{Maximum capacity of outdoor units} = \text{Capacity of outdoor units from capacity table at installed connection ratio} \times \text{Correction ratio of piping to furthest indoor}$$

- When level difference is 50 m or more (see installation manual and 3D079540 / 3D079543) and equivalent pipe length is 90 m or more, the diameter of the main gas and liquid pipes (outdoor unit - branch sections) must be increased. For new diameters, see below.

Model	Gas	Liquid
50 HP	41.3	22.2

- When the pipe length after the first refrigerant branch kit is more than 40 m, pipe size between first and final branch kit must be increased (only for VRV DX indoor units; details see installation manual).

*Refer to the installation manual for allowed system setups and rules for dedicated indoor connection types.

Diameter of main pipes (standard size)

Model	Gas	Liquid
50 HP	41.3	19.1

- Equivalent length used in the above figures is based upon the following equivalent length

$$\text{Equivalent piping length} = \text{Equivalent length of main pipe} \times \text{Correction factor} + \text{Equivalent length of branch pipes}$$

Choose a correction factor from the following table. When cooling capacity is calculated: gas pipe size When heating capacity is calculated: liquid pipe size

	Correction factor	
	Standard size	Size increase
Cooling (gas pipe)	1.0	0.5
Heating (liquid pipe)	1.0	0.5

Example

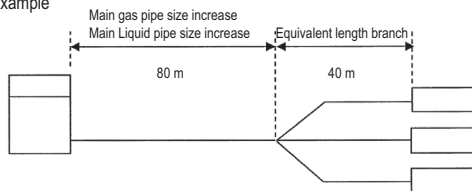

In the above case (Cooling) Overall equivalent length = 80 m x 1.0 + 40 m = 120 m
 (Heating) Overall equivalent length = 80 m x 0.5 + 40 m = 80 m
 The rate of change in cooling capacity when height difference = 0 is thus approximately 0.83
 heating capacity when height difference = 0 is thus approximately 0.92

5 Capacity tables

5 - 2 Capacity Correction Factor

RYYQ52U
RXYQQ52U
RXYQ52U

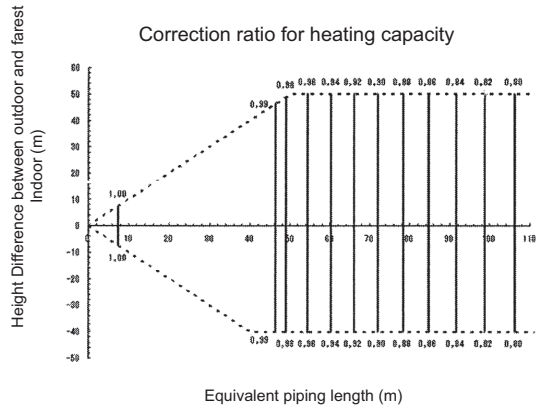
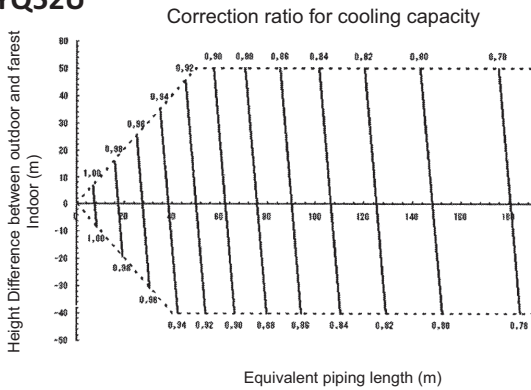

NOTES

- These figures illustrate the correction ratio for piping length in capacity for a standard indoor unit system at maximum load (with the thermostat set to maximum) under standard conditions. Moreover, under partial load conditions, there is only a minor deviation for the capacity correction ratio, shown in the above figures.
- With this outdoor unit, constant evaporating pressure control when cooling and constant condensing pressure control when heating is carried out.
- Method of calculating the capacity of the outdoor units
The maximum capacity of the system will be either the total capacity of the indoor units or the maximum capacity of the outdoor units as mentioned below, whichever is smaller.

Condition: Indoor connection ratio does not exceed 100%.

$$\text{Maximum capacity of outdoor units} = \text{Capacity of outdoor units from capacity table at the 100\% connection ratio} \times \text{Correction ratio of piping to furthest indoor}$$

Condition: Indoor connection ratio exceeds 100%.

$$\text{Maximum capacity of outdoor units} = \text{Capacity of outdoor units from capacity table at installed connection ratio} \times \text{Correction ratio of piping to furthest indoor}$$

- When level difference is 50 m or more (see installation manual and 3D079540 / 3D079543) and equivalent pipe length is 90 m or more, the diameter of the main gas and liquid pipes (outdoor unit - branch sections) must be increased. For new diameters, see below.

Model	Gas	Liquid
52 HP	41.3	22.2

- When the pipe length after the first refrigerant branch kit is more than 40 m, pipe size between first and final branch kit must be increased (only for VRV DX indoor units; details see installation manual).

*Refer to the installation manual for allowed system setups and rules for dedicated indoor connection types.

Diameter of main pipes (standard size)

Model	Gas	Liquid
52 HP	41.3	19.1

- Equivalent length used in the above figures is based upon the following equivalent length

$$\text{Equivalent piping length} = \text{Equivalent length of main pipe} \times \text{Correction factor} + \text{Equivalent length of branch pipes}$$

Choose a correction factor from the following table. When cooling capacity is calculated: gas pipe size. When heating capacity is calculated: liquid pipe size

	Correction factor	
	Standard size	Size increase
Cooling (gas pipe)	1.0	0.5
Heating (liquid pipe)	1.0	0.5

Example

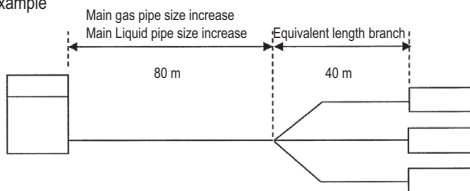

In the above case (Cooling) Overall equivalent length = 80 m x 1.0 + 40 m = 120 m
(Heating) Overall equivalent length = 80 m x 0.5 + 40 m = 80 m
The rate of change in cooling capacity when height difference = 0 is thus approximately 0.83
heating capacity when height difference = 0 is thus approximately 0.88

5 Capacity tables

5 - 2 Capacity Correction Factor

5

RYYQ54U
RXYQ54U
RXYQ54U

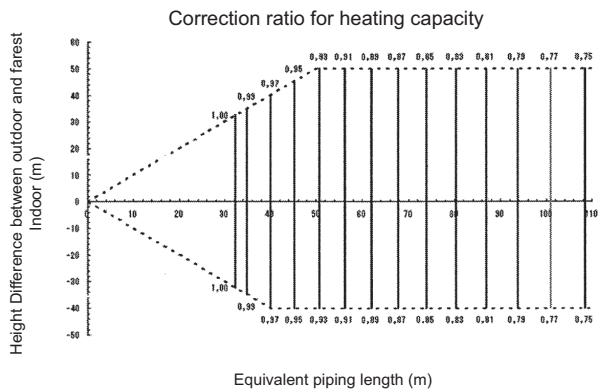
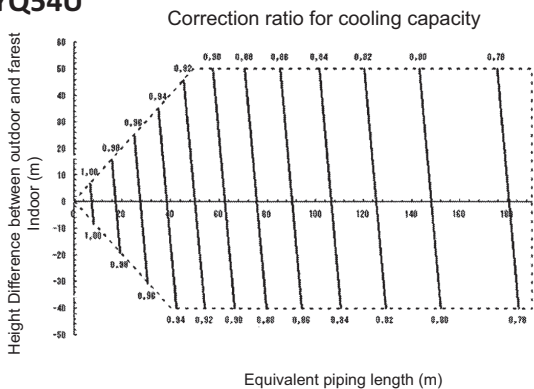

NOTES

- These figures illustrate the correction ratio for piping length in capacity for a standard indoor unit system at maximum load (with the thermostat set to maximum) under standard conditions. Moreover, under partial load conditions, there is only a minor deviation for the capacity correction ratio, shown in the above figures.
- With this outdoor unit, constant evaporating pressure control when cooling and constant condensing pressure control when heating is carried out.
- Method of calculating the capacity of the outdoor units
The maximum capacity of the system will be either the total capacity of the indoor units or the maximum capacity of the outdoor units as mentioned below, whichever is smaller.

Condition: Indoor connection ratio does not exceed 100%.

$$\text{Maximum capacity of outdoor units} = \text{Capacity of outdoor units from capacity table at the 100\% connection ratio} \times \text{Correction ratio of piping to furthest indoor}$$

Condition: Indoor connection ratio exceeds 100%.

$$\text{Maximum capacity of outdoor units} = \text{Capacity of outdoor units from capacity table at installed connection ratio} \times \text{Correction ratio of piping to furthest indoor}$$

- When level difference is 50 m or more (see installation manual and 3D079540 / 3D079543) and equivalent pipe length is 90 m or more, the diameter of the main gas and liquid pipes (outdoor unit - branch sections) must be increased. For new diameters, see below.

Model	Gas	Liquid
54 HP	41.3	22.2

- When the pipe length after the first refrigerant branch kit is more than 40 m, pipe size between first and final branch kit must be increased (only for VRV DX indoor units; details see installation manual).
*Refer to the installation manual for allowed system setups and rules for dedicated indoor connection types.

Diameter of main pipes (standard size)

Model	Gas	Liquid
54 HP	41.3	19.1

- Equivalent length used in the above figures is based upon the following equivalent length

$$\text{Equivalent piping length} = \text{Equivalent length of main pipe} \times \text{Correction factor} + \text{Equivalent length of branch pipes}$$

Choose a correction factor from the following table. When cooling capacity is calculated: gas pipe size When heating capacity is calculated: liquid pipe size

	Correction factor	
	Standard size	Size increase
Cooling (gas pipe)	1.0	0.5
Heating (liquid pipe)	1.0	0.5

Example

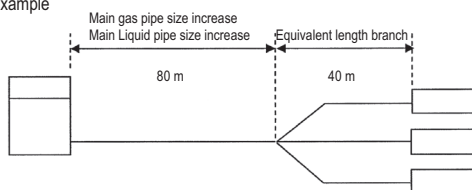

In the above case (Cooling) Overall equivalent length = 80 m x 1.0 + 40 m = 120 m
(Heating) Overall equivalent length = 80 m x 0.5 + 40 m = 80 m

The rate of change in cooling capacity when height difference = 0 is thus approximately 0.83
heating capacity when height difference = 0 is thus approximately 0.83

6 Dimensional drawings

6 - 1 Dimensional Drawings

REMQ5U
REYQ8-12U
RXYQQ8-12U
RXYQ8-12U
RYMQ8-12U
RXYTQ8-UYF
RYYQ8-12U

Notes

- Detail 'A' and detail 'B' indicate the dimensions after fixing the attached piping.
- Items 4 - 10: Knockout hole.
- Gas pipe
- RYYQ8U, RYMQ8U, RXYQ8U, RXYQQ8U, RXYTQ8U : \varnothing 19.1- brazing connection
 RYYQ10U, RYMQ10U, RXYQ10U, RXYQQ10U : \varnothing 22.2- brazing connection
 REMQ5U, REYQ8-12U : \varnothing 25.4- brazing connection
 RYYQ12U, RYMQ12U, RXYQ12U, RXYQQ12U : \varnothing 28.6- brazing connection
 Liquid pipe
- RYYQ8-10U, RYMQ8-10U, RXYQ8-10U, RXYQQ8-10U, : \varnothing 9.5- brazing connection
 REMQ5U, REYQ8-12U, RXYTQ8U
- RYYQ12U, RYMQ12U, RXYQ12U, RXYQQ12U : \varnothing 12.7- brazing connection

Equalising pipe

- RYMQ8-10U : \varnothing 19.1- brazing connection
- RYMQ12U : \varnothing 22.2- brazing connection

High pressure/low pressure gas pipe

- REMQ5U, REYQ8-12U : \varnothing 19.1- brazing connection

Model	AA	AB
RYYQ8-12U, RXYQ8-12U, RXYQQ8-12U, RXYTQ8U	-	-
REMQ5U, RYMQ8-12U, REYQ8-12U	246	240

11	Grounding terminal	
10	Pipe routing hole (bottom)	
9	Pipe routing hole (front)	Inside of the switch box (-M8-)
8	Power cord routing hole (bottom)	065
7	Power cord routing hole (front)	027
6	Power cord routing hole (front)	065
5	Power cord routing hole (front)	080
4	Power cord routing hole (side)	065
3	Equalising pipe connection port	See note -3-
	High pressure/low pressure gas pipe	See note -3-
2	Gas pipe connection port	See note -3-
1	Liquid pipe connection port	Remark
No.	Part name	

2D119001

REYQ14-20U
RXYQQ14-20U
RXYTQ14-20U
RYYQ14-20U
RYM14-20U

Notes

- Detail A and detail B indicate the dimensions after fixing the attached piping.
- Items 4 - 10: Knockout hole.
- Gas pipe
- RXYTQ10U : \varnothing 22.2 brazing connection
 REYQ14-20U : \varnothing 25.4 brazing connection
 RYYQ14-20U, RYM14-20U, RXYQ14-20U, RXYQQ14-20U, RXYTQ12-16U Liquid pipe : \varnothing 28.6 brazing connection
- RXYTQ10U : \varnothing 9.5 brazing connection
 RYYQ14-16U, RYM14-16U, RXYQ14-16U, RXYQQ14-16U, REYQ14-20U, RXYTQ12-16U : \varnothing 12.7 brazing connection
 RYYQ18-20U, RYM18-20U, RXYQ18-20U, RXYQQ18-20U Equalising pipe : \varnothing 15.9 brazing connection
- RYM14-16U : \varnothing 22.2 brazing connection
 RYM18-20U : \varnothing 28.6 brazing connection

High pressure/low pressure gas pipe

- REYQ14-20U : \varnothing 22.2 brazing connection

Model	AA	AB
RXYQ14-20U, RYYQ14-20U, RXYQQ14-20U, RXYTQ10-16U	-	-
RYM14-16U, REYQ14-20U	240	155
RYM18-20U	240	192

11	Grounding terminal	
10	Pipe routing hole (bottom)	
9	Pipe routing hole (front)	Inside of the switch box (M8)
8	Power cord routing hole (bottom)	065
7	Power cord routing hole (front)	027
6	Power cord routing hole (front)	065
5	Power cord routing hole (front)	080
4	Power cord routing hole (side)	065
3	Equalising pipe connection port	See note 3.
	High pressure/low pressure gas pipe	See note 3.
2	Gas pipe connection port	See note 3.
1	Liquid pipe connection port	See note 3.
No.	Part name	Remark

2D119091

7 Centre of gravity

7 - 1 Centre of Gravity

7

RXYQQ8-12U
RXYQ8-12U
RXYTQ8U
RYYQ8-12U
RYMQ8-12U

Unit	AA	AB	AC
RYYQ8-12U	328	366	565
REM05U / REYQ8-12U			
RYMQ8-12U	354	443	565
RXYQ8-12U	339	448	565
RXYQQ8-12U			
RXYTQ8U			

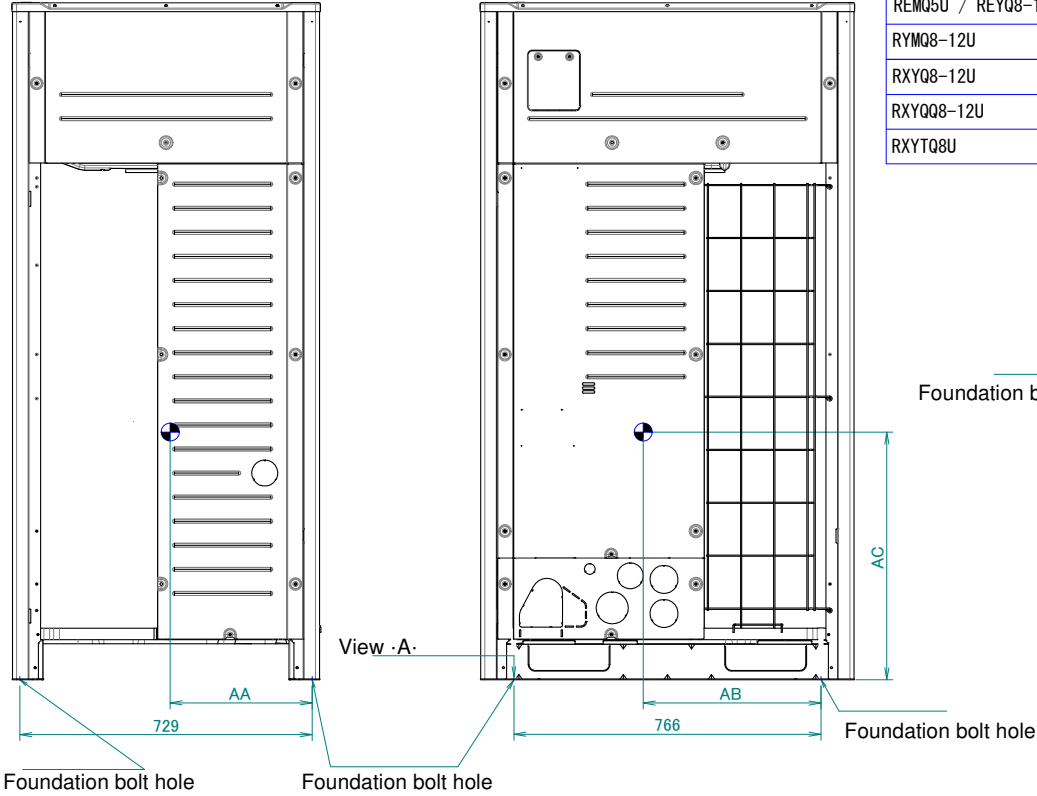

3D119703

RXYQQ14-20U
RXYQ14-20U
RXYTQ10-16U
RYYQ14-20U
RYMQ14-20U

Unit	AA	AB	AC
RYYQ14-20U	334	470	610
REYQ14-20U	334	470	610
RYMQ14-20U	360	569	610
RXYQ(Q) 14-20U	345	575	610
RXYTQ10-12U	350	610	810
RXYTQ14-16U	351	565	610

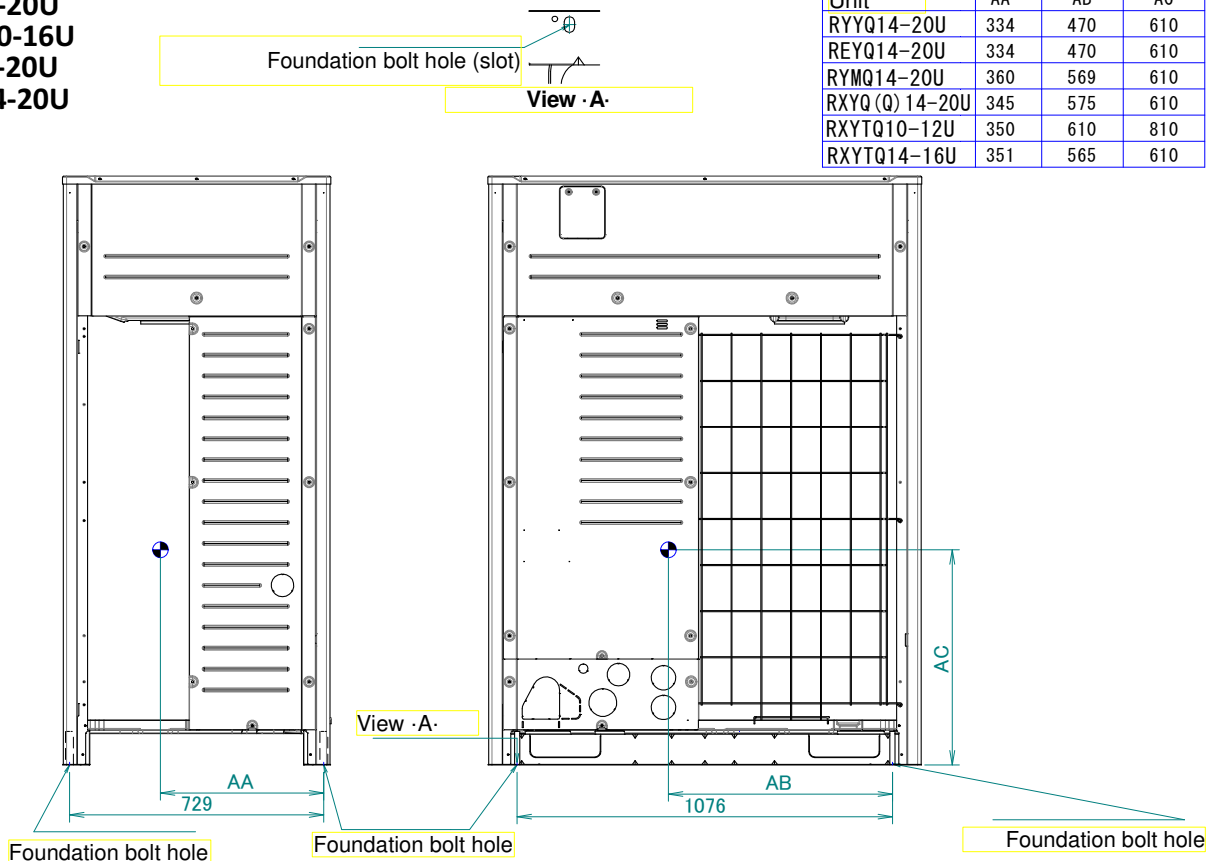

3D119704

8 Piping diagrams

8 - 1 Piping Diagrams

RXYQ8-12U
RXYTQ8UYF

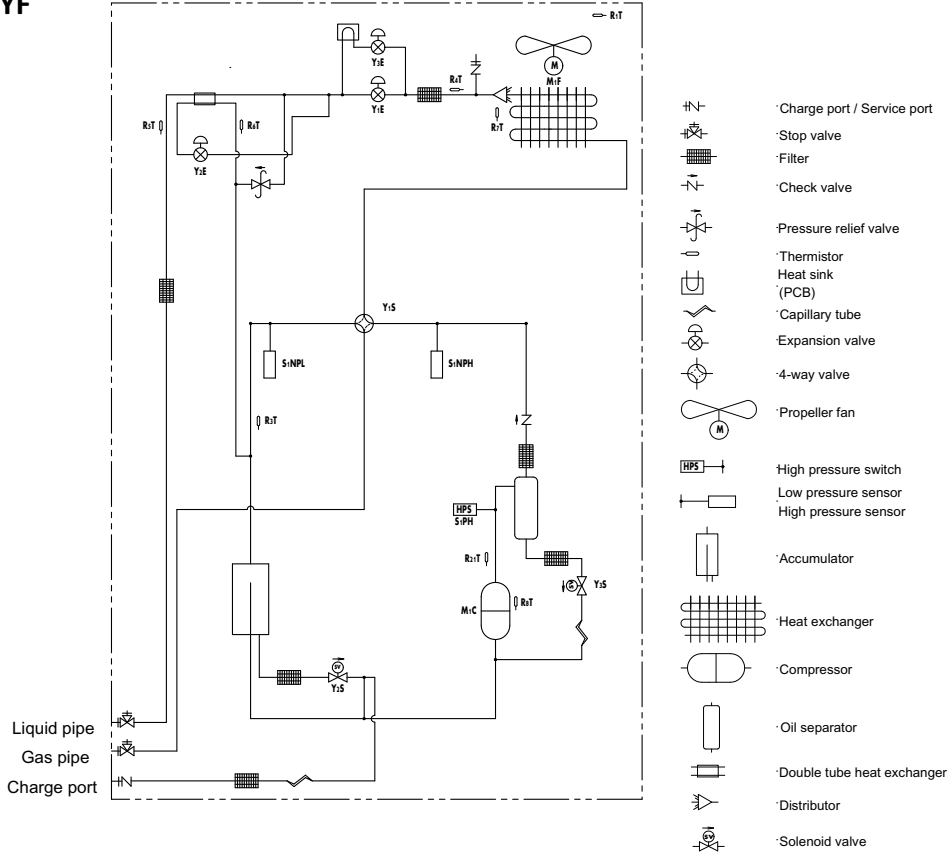

3D118179

RXYQ14-20U
RXYQ14-16UYF

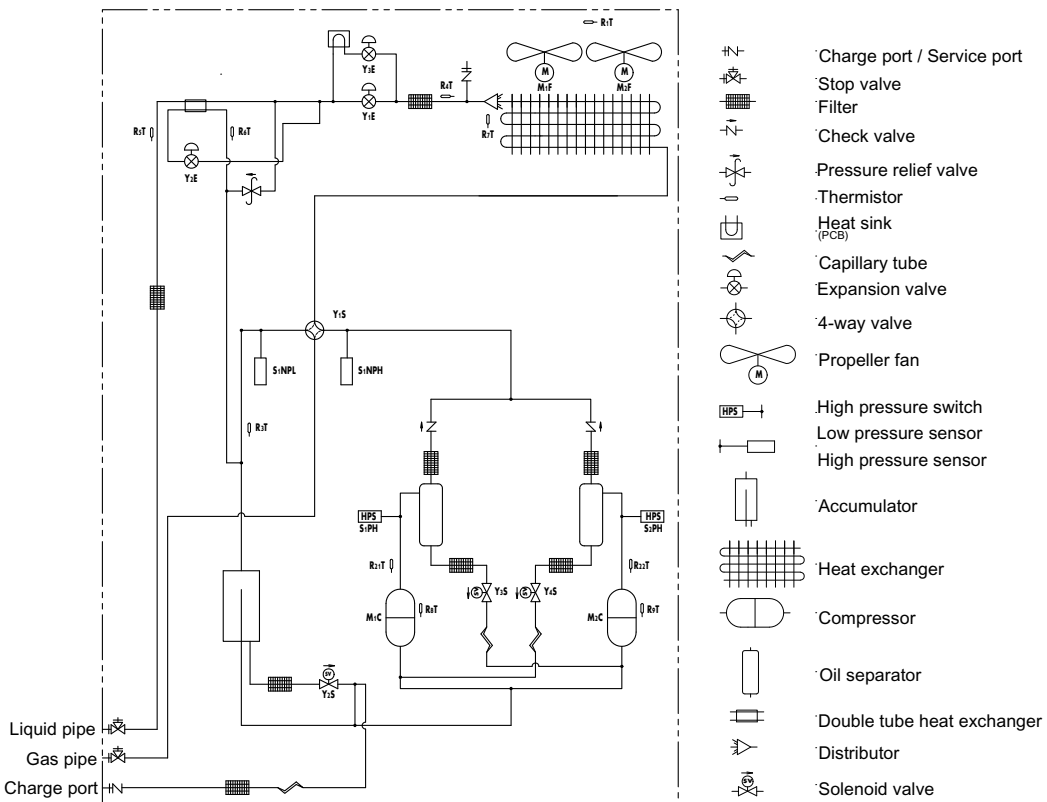

3D118180

9 Wiring diagrams

9 - 1 Wiring Diagrams - Three Phase

9

RXYQ8-12U
 RXYTQ8UYF
 RYYQ8-12U
 RYMQ8-12U

Power supply 3N~ 380-415V 50Hz
 3N~ 380V 60Hz

Wiring diagram

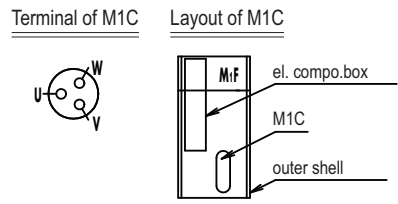
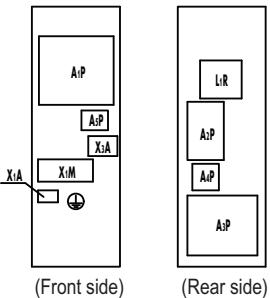
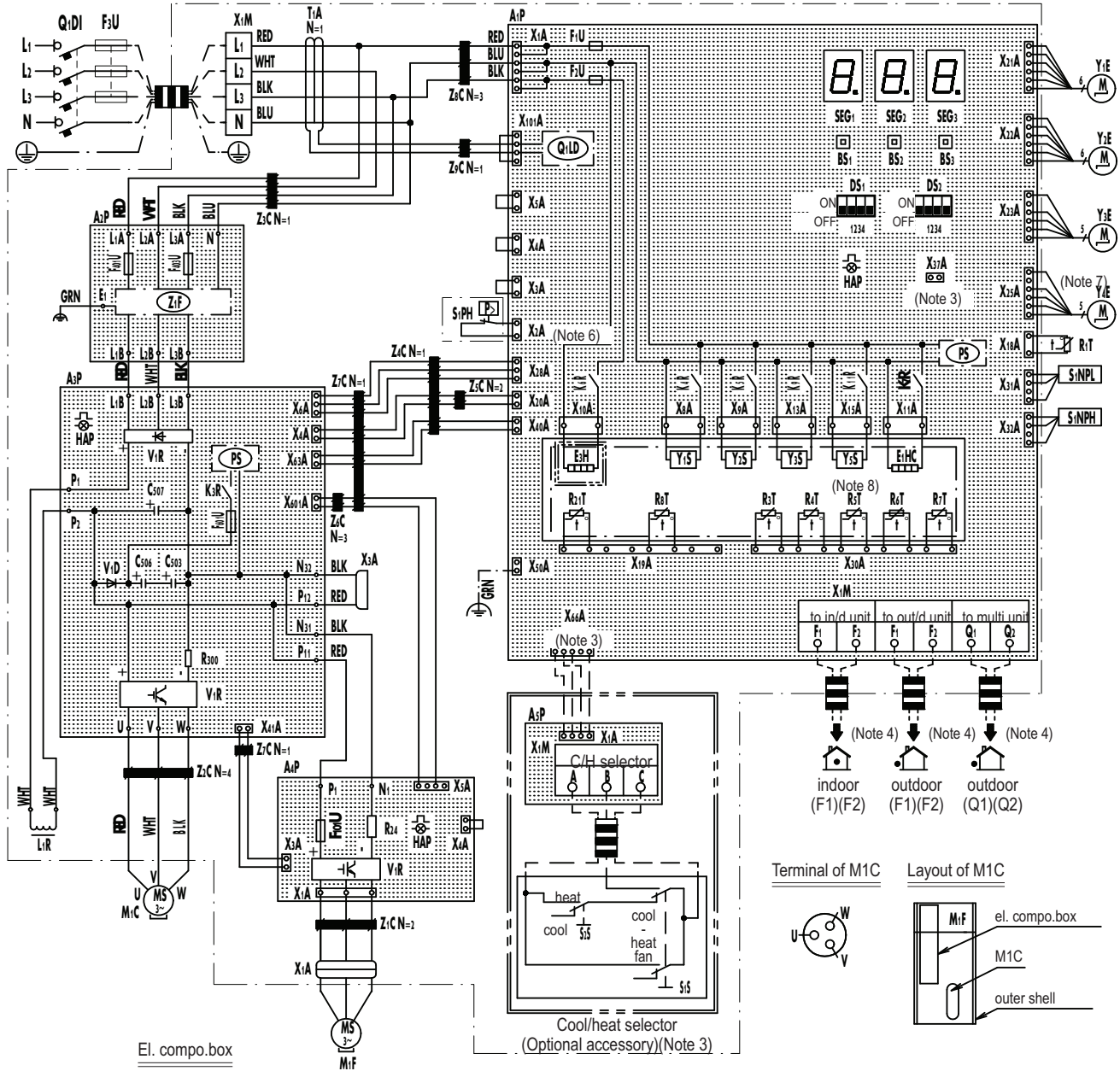

9 Wiring diagrams

9 - 1 Wiring Diagrams - Three Phase

RXYQ8-12U
RXYTQ8UYF
RYYQ8-12U
RYMQ8-12U

A1P	Printed Circuit Board (Main)	R3T	Thermistor (Accumulator)
A2P	Printed Circuit Board (Noise Filter)	R4T	Thermistor (Heat Exc,Liq,Pipe)
A3P	Printed Circuit Board (Inv)	R5T	Thermistor (Subcool,Liq,Pipe)
A4P	Printed Circuit Board (Fan)	R6T	Thermistor (Heat Exc,Gas Pipe)
A5P	Printed Circuit Board (ABC I/P)(Option)	R7T	Thermistor (Heat Exc,Deicer)
BS1~3 (A1P)	Push Button Switch (Mode,Set,Return)	R8T	Thermistor (M1C body)
C503,C506,C507 (A3P)	Capacitor	R21T	Thermistor (M1C discharge)
DS1,DS2 (A1P)	DIP Switch	S1NPH	Pressure Sensor (High)
E1HC	Crankcase Heater	S1NPL	Pressure Sensor (Low)
E3H	Drainpan Heater (Option)	S1PH	Pressure Switch (Disch)
F1U,F2U (A1P)	Fuse (T,3,15A,250V)	SEG1~SEG3 (A1P)	7-Segment Display
F3U	Field Fuse	T1A	Current Sensor
F101U (A4P)	Fuse	V1D (A3P)	Diode
F401U,F403U (A2P)	Fuse	V1R (A3P,A4P)	Power Module
F601U (A3P)	Fuse	X*A	Connector
HAP (A1P,A3P, A4P)	Pilotlamp (Service Monitor-Green)	X1M (A1P)	Terminal Block (Control)
K3R (A3P)	Magnetic Relay	X1M (A5P)	Terminal Block (Power Supply)(Option)
K4R (A1P)	Magnetic Relay (Y1S)	Y1E	Electronic Expansion Valve(Main)
K5R (A1P)	Magnetic Relay (Y2S)	Y2E	Electronic Expansion Valve (Injection)
K6R (A1P)	Magnetic Relay (E3H)	Y3E	Electronic Expansion Valve (Refrigerant Jacket)
K7R (A1P)	Magnetic Relay (E1HC)	Y4E	Electronic Expansion Valve (Storage Vessel)
K9R (A1P)	Magnetic Relay (Y3S)	Y1S	Solenoid Valve (Main)
K11R (A1P)	Magnetic Relay (Y5S)	Y2S	Solenoid Valve (Accumulator Oil Return)
L1R	Reactor	Y3S	Solenoid Valve (Oil1)
M1C	Motor (Compressor)	Y5S	Solenoid Valve (Sub)
M1F	Motor (Fan)	Z*C	Noise Filter (Ferrite Core)
PS (A1P,A3P)	Switching Power Supply	Z*F (A2P)	Noise Filter (With Surge Absorber)
Q1DI	Field Earth Leakage Breaker	Connector For Optional Accessories	
Q1LD (A1P)	Field Earth Current Detector	X10A	Connector (Drainpan Heater)
R24 (A4P)	Resistor (Current Sensor)	X37A	Connector (Power Adapter)
R300 (A3P)	Resistor (Current Sensor)	X66A	Connector (Remote Switching Cool/Heat Selector)
R1T	Thermistor (Air)		

NOTES

- This wiring diagram applies only to the outdoor unit.
- :field wiring, :terminal block, :connector, :terminal, : protective earth (screw), : functional earth, : earth wiring, : field supply, : PCB, : switch box, : option
- When using the optional adapter, refer to the installation manual of the optional adapter.
- For connection wiring to indoor-outdoor transmission F1-F2, outdoor-outdoor transmission F1-F2, outdoor-multi transmission Q1-Q2, refer to the installation manual.
- How to use BS1~3 switch. Refer to "service precaution" label on el. compo. box cover.
- When operating, don't shortcircuit the protection devices (S1PH).
- Only for RYYQ model.
- Only for RYYQ/RYMQ model.
- Colors: BLK: Black, RED: Red, BLU: Blue, WHT: White, GRN: Green.

2D117534

9 Wiring diagrams

9 - 1 Wiring Diagrams - Three Phase

RXYQ14-20U
 RXYTQ14-16U
 RYYQ14-20U
 RYMQ14-20U

Wiring diagram

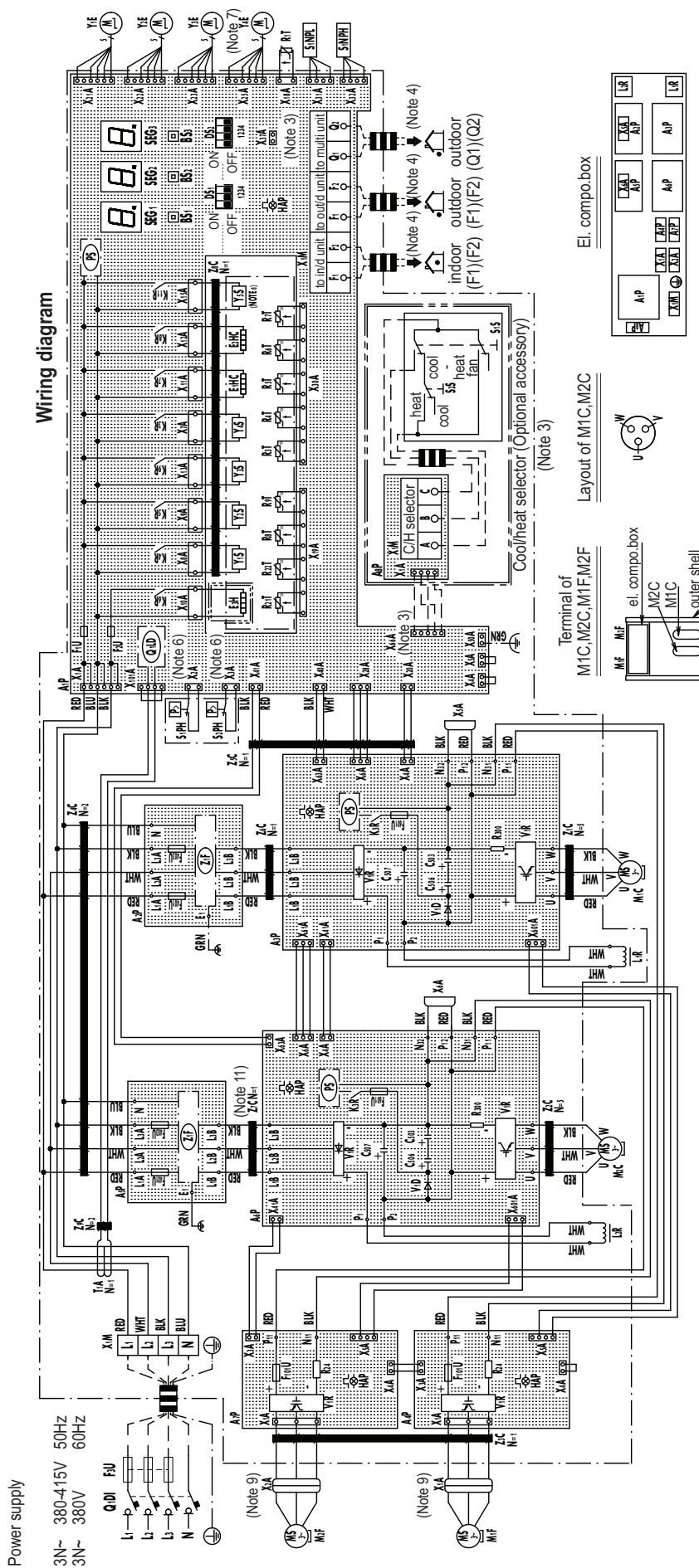

2D117536B

9 Wiring diagrams

9 - 1 Wiring Diagrams - Three Phase

RXYQ14-20U
RXYTQ14-16U
RYYQ14-20U
RYMQ14-20U

A1P	Printed Circuit Board (Main)	R3T	Thermistor (Accumulator)
A2P,A5P	Printed Circuit Board (Noise Filter)	R4T	Thermistor (Heat Exc,Liq,Pipe)
A3P,A6P	Printed Circuit Board (Inv)	R5T	Thermistor (Subcool,Liq,Pipe)
A4P,A7P	Printed Circuit Board (Fan)	R6T	Thermistor (Heat Exc,Gas Pipe)
A8P	Printed Circuit Board (ABC I/P)	R7T	Thermistor (Heat Exc,Deicer)
C503,C506,C507 (A3P,A6P)	Capacitor	R8T,R9T	Thermistor (M1C ,M2C body)
DS1,DS2 (A1P)	DIP Switch	R21T,R22T	Thermistor (M1C ,M2C discharge)
E1HC,E2HC	Crankcase Heater	S1NPH	Pressure Sensor (High)
E3H	Drainpan Heater (Option)	S1NPL	Pressure Sensor (Low)
F1U,F2U (A1P)	Fuse (T,3,15A,250V)	S1PH,S2PH	Pressure Switch (Disch)
F3U	Field Fuse	SEG1~SEG3 (A1P)	7-Segment Display
F101U (A4P,A7P)	Fuse	T1A	Current Sensor
F401U,F403U (A2P,A5P)	Fuse	V1D (A3P,A6P)	Diode
F601U (A3P,A6P)	Fuse	V1R (A3P,A4P,A6P,A7P)	Power Module
HAP (A1P,A3P,A4P,A6P,A7P)	Pilotlamp (Service Monitor-Green)	X*A	Connector
K3R (A3P,A6P)	Magnetic Relay	X1M (A1P)	Terminal Block (Control)
K3R (A1P)	Magnetic Relay (Y4S)	X1M (A8P)	Terminal Block (Power Supply)
K4R (A1P)	Magnetic Relay (Y1S)	Y1E	Electronic Expansion Valve(Main)
K5R (A1P)	Magnetic Relay (Y2S)	Y2E	Electronic Expansion Valve (Injection)
K6R (A1P)	Magnetic Relay (E3H)	Y3E	Electronic Expansion Valve (Refrigerant Jacket)
K7R (A1P)	Magnetic Relay (E1HC)	Y4E	Electronic Expansion Valve (Storage Vessel) (Note 7)
K8R (A1P)	Magnetic Relay (E2HC)	Y1S	Solenoid Valve (Main)
K9R (A1P)	Magnetic Relay (Y3S)	Y2S	Solenoid Valve (Accumulator Oil Return)
K11R (A1P)	Magnetic Relay (Y5S)	Y3S	Solenoid Valve (Oil1)
L1R,L2R	Reactor	Y3S	Solenoid Valve (Oil2)
M1C,M2C	Motor (Compressor)	Y5S	Solenoid Valve (Sub) (Note 8)
M1F,M2F	Motor (Fan)	Z*C	Noise Filter (Ferrite Core)
PS (A1P,A3P,A6P)	Switching Power Supply	Z*F (A2P,A5P)	Noise Filter (With Surge Absorber)
Q1DI	Field Earth Leakage Breaker	Connector For Optional Accessories	
Q1LD (A1P)	Field Earth Current Detector	X10A	Connector (Drainpan Heater)
R24 (A4P,A7P)	Resistor (Current Sensor)	X37A	Connector (Power Adapter)
R300 (A3P,A6P)	Resistor (Current Sensor)	X66A	Connector (Remote Switching Cool/Heat Selector)
R1T	Thermistor (Air)		

NOTES

1. This wiring diagram applies only to the outdoor unit.
2. :field wiring, : terminal block, : connector, : terminal, : protective earth (screw), : functional earth, : earth wiring, : field supply, : PCB, : switch box, : option
3. When using the optional adapter, refer to the installation manual of the optional adapter.
4. For connection wiring to indoor-outdoor transmission F1-F2, outdoor-outdoor transmission F1-F2, outdoor-multi transmission Q1-Q2, refer to the installation manual.
5. How to use BS1~3 switch. Refer to "service precaution" label on el. compo. box cover.
6. When operating, don't shortcircuit the protection devices (S1PH, S2PH).
7. Only for RYYQ model.
8. Only for RYYQ/RYMQ model.
9. Connector x1a (m1f) is red, connector x2a (m2f) is white.
10. Colors: BLK: Black, RED: Red, BLU: Blue, WHT: White, GRN: Green.
11. Only for 14,16 class

2D117536B

10 External connection diagrams

10 - 1 External Connection Diagrams

10

RXYQQ8-20U
RXYQ8-20U
RYYQ8-20U
RYMQ8-20U
RXYTQ8-16UYF

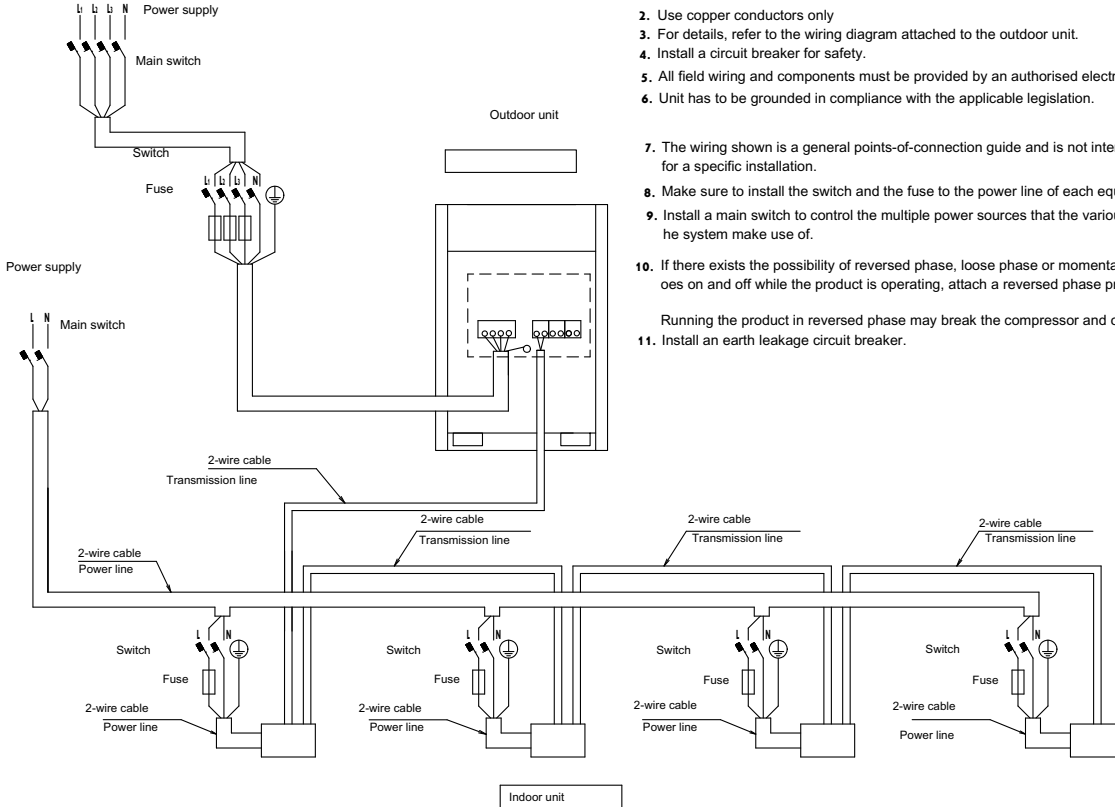

Notes

1. All wiring, components and materials to be procured on-site must comply with the applicable legislation.
2. Use copper conductors only
3. For details, refer to the wiring diagram attached to the outdoor unit.
4. Install a circuit breaker for safety.
5. All field wiring and components must be provided by an authorised electrician.
6. Unit has to be grounded in compliance with the applicable legislation.
7. The wiring shown is a general points-of-connection guide and is not intended to include all details for a specific installation.
8. Make sure to install the switch and the fuse to the power line of each equipment.
9. Install a main switch to control the multiple power sources that the various components of the system make use of.
10. If there exists the possibility of reversed phase, loose phase or momentary blackout, or if the power goes on and off while the product is operating, attach a reversed phase protection circuit locally.
- Running the product in reversed phase may break the compressor and other parts.
11. Install an earth leakage circuit breaker.

3D119317

RXYQQ8-20U
RXYQ8-20U
RXYTQ8-16U
RYYQ8-20U
RYMQ8-26U

Notes

1. All wiring, components and materials to be procured on-site must comply with the applicable legislation.
2. Use copper conductors only
3. For details, refer to the wiring diagram attached to the outdoor unit.
4. Install a circuit breaker for safety.
5. All field wiring and components must be provided by an authorised electrician.
6. Unit has to be grounded in compliance with the applicable legislation.
7. The wiring shown is a general points-of-connection guide and is not intended to include all details for a specific installation.
8. Make sure to install the switch and the fuse to the power line of each equipment.
9. Install a main switch to control the multiple power sources that the various components of the system make use of.
10. The capacity of UNIT1 must be larger than that of UNIT2 when the power source is connected in series between the units.
11. If there exists the possibility of reversed phase, loose phase or momentary blackout, or if the power goes on and off while the product is operating, attach a reversed phase protection circuit locally.
- Running the product in reversed phase may break the compressor and other parts.
12. Install an earth leakage circuit breaker.

< Power source is supplied to each outdoor unit individually. >

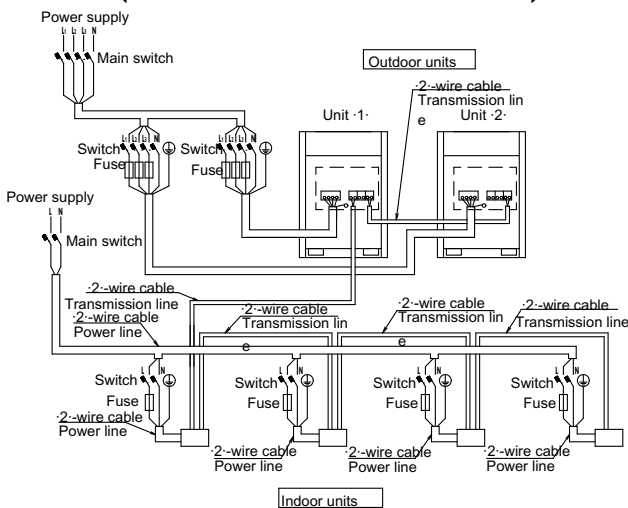

< Power source is connected in series between the units. >

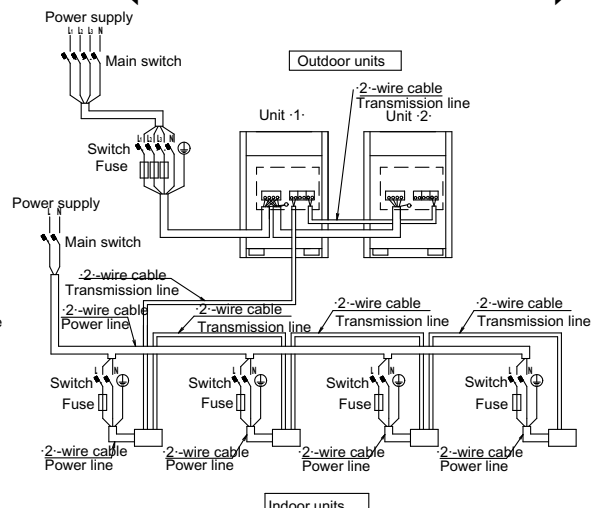

3D119316

10 External connection diagrams

10 - 1 External Connection Diagrams

RXYQQ8-20U
RXYQ8-20U
RXYTQ8-16UYF
RYYQ8-20U
RYMQ8-20U

Notes

1. All wiring, components and materials to be procured on-site must comply with the applicable legislation.
2. Use copper conductors only
3. For details, refer to the wiring diagram attached to the outdoor unit.
4. Install a circuit breaker for safety.
5. All field wiring and components must be provided by an authorised electrician.
6. Unit has to be grounded in compliance with the applicable legislation.
7. The wiring shown is a general points-of-connection guide and is not intended to include all details for a specific installation.
8. Make sure to install the switch and the fuse to the power line of each equipment.
9. Install a main switch to control the multiple power sources that the various components of the system make use of.
10. The capacity of UNIT1 must be larger than that of UNIT2 when the power source is connected in series between the units.
 The capacity of UNIT 2 must be larger than that of UNIT3 when the power source is connected in series between the units.
11. If there exists the possibility of reversed phase, loose phase or momentary blackout, or if the power goes on and off while the product is operating, attach a reversed phase protection circuit locally.
 Running the product in reversed phase may break the compressor and other parts.
12. Install an earth leakage circuit breaker.

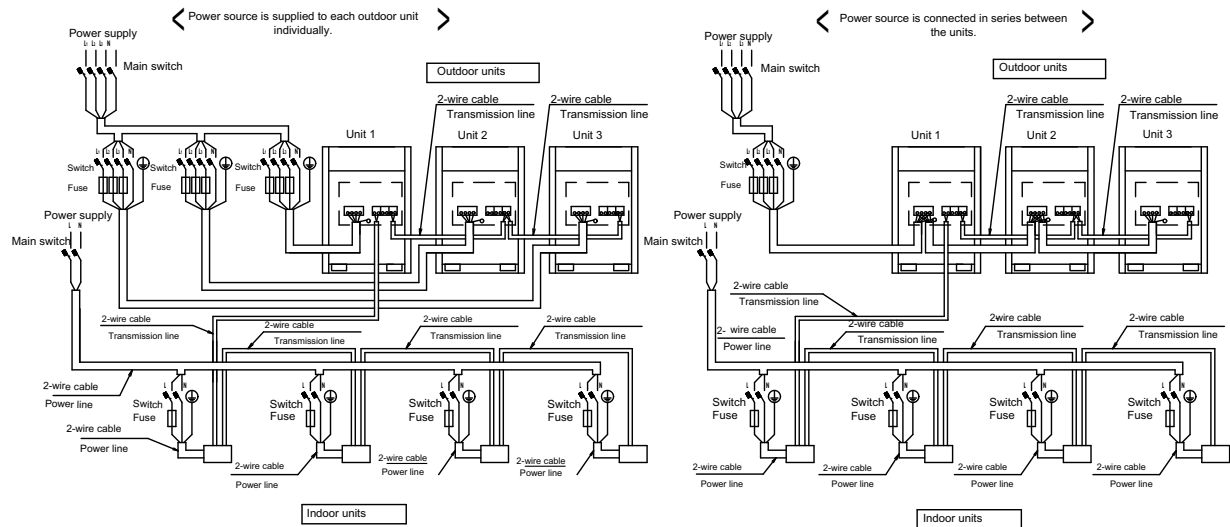

3D119200

11 Sound data

11 - 1 Sound Power Spectrum

11

REMQ5U
REYQ8U
RXYQQ8U
RXYQ8U
RXYTQ8UYF
RYYQ8U
RYMQ8U

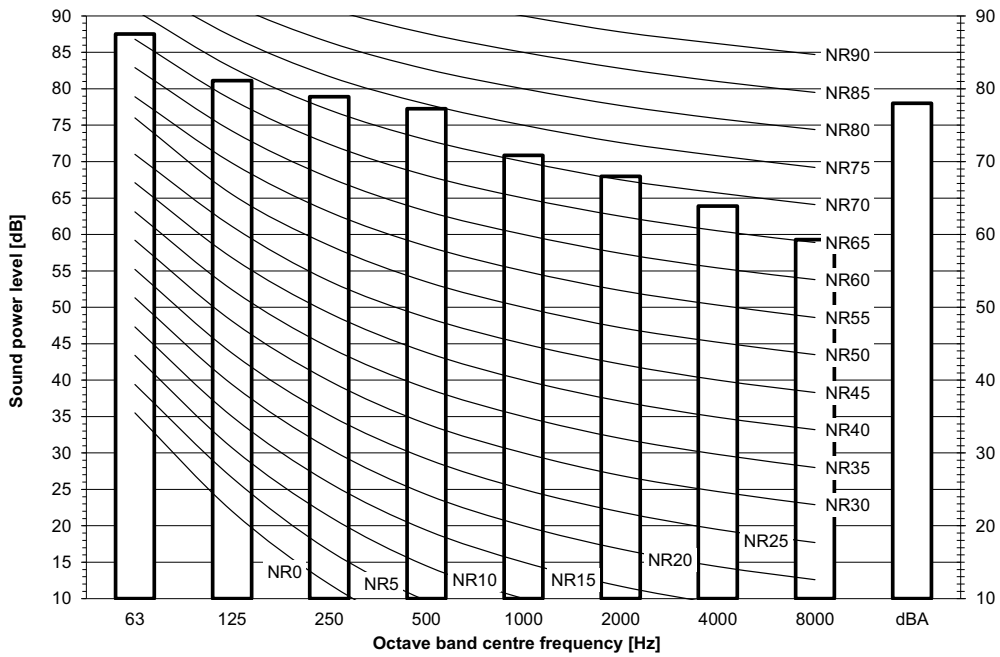

Notes
 dBA = A-weighted sound power level (A scale according to IEC).
 Reference acoustic intensity 0dB = 10E-6μW/m²
 Measured according to ISO 3744

3D119528

REYQ10U
RXYQQ10U
RXYQ10U
RYYQ10U
RYMQ10U

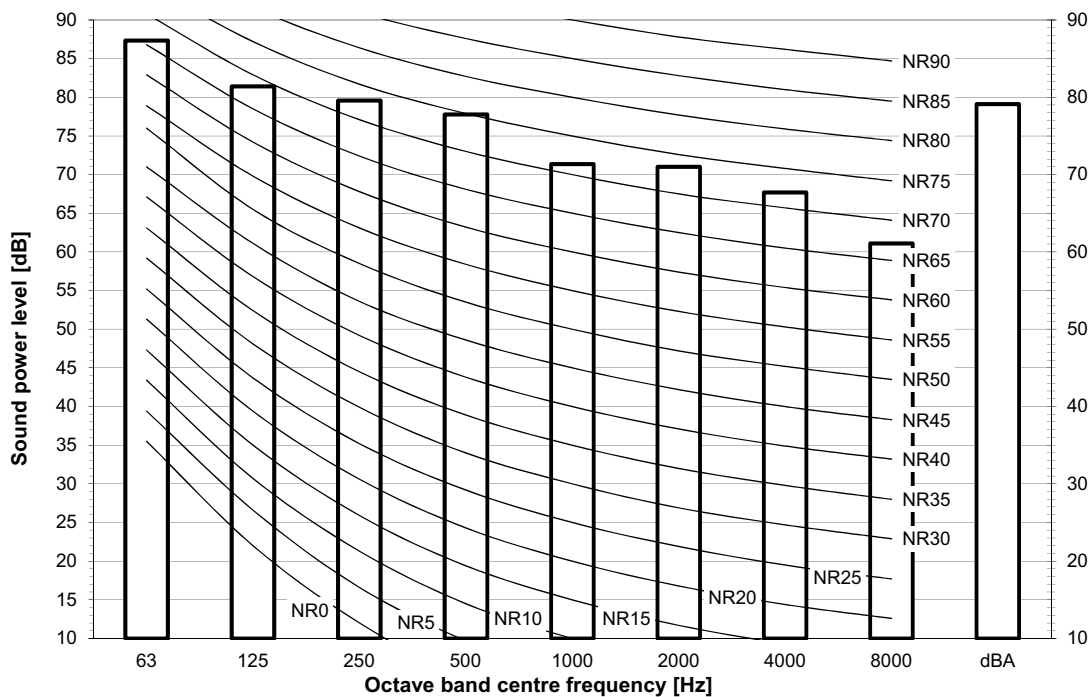

Notes
 dBA = A-weighted sound power level (A scale according to IEC).
 Reference acoustic intensity 0dB = 10E-6μW/m²
 Measured according to ISO 3744

3D119529

11 Sound data

11 - 1 Sound Power Spectrum

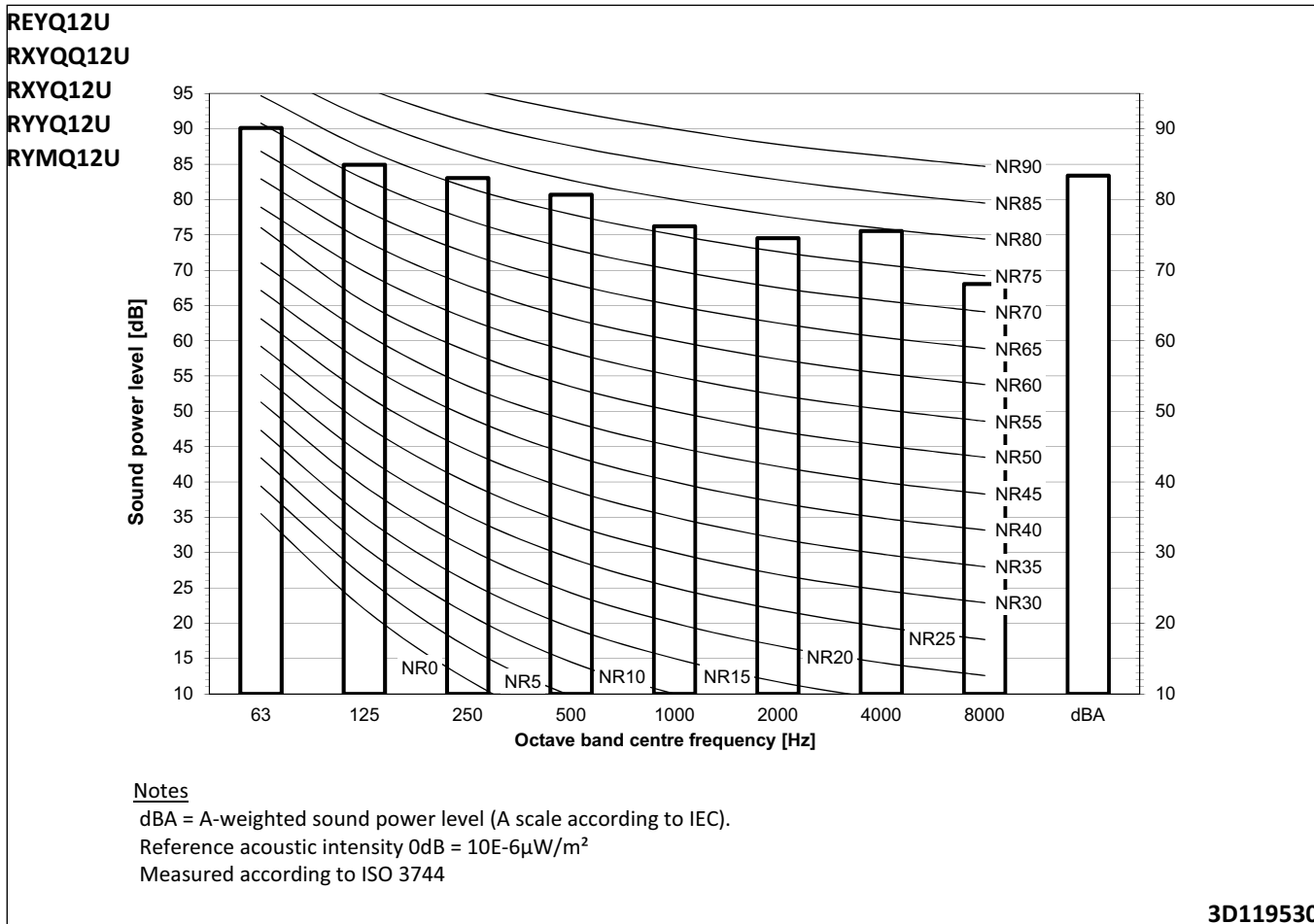

3D119530

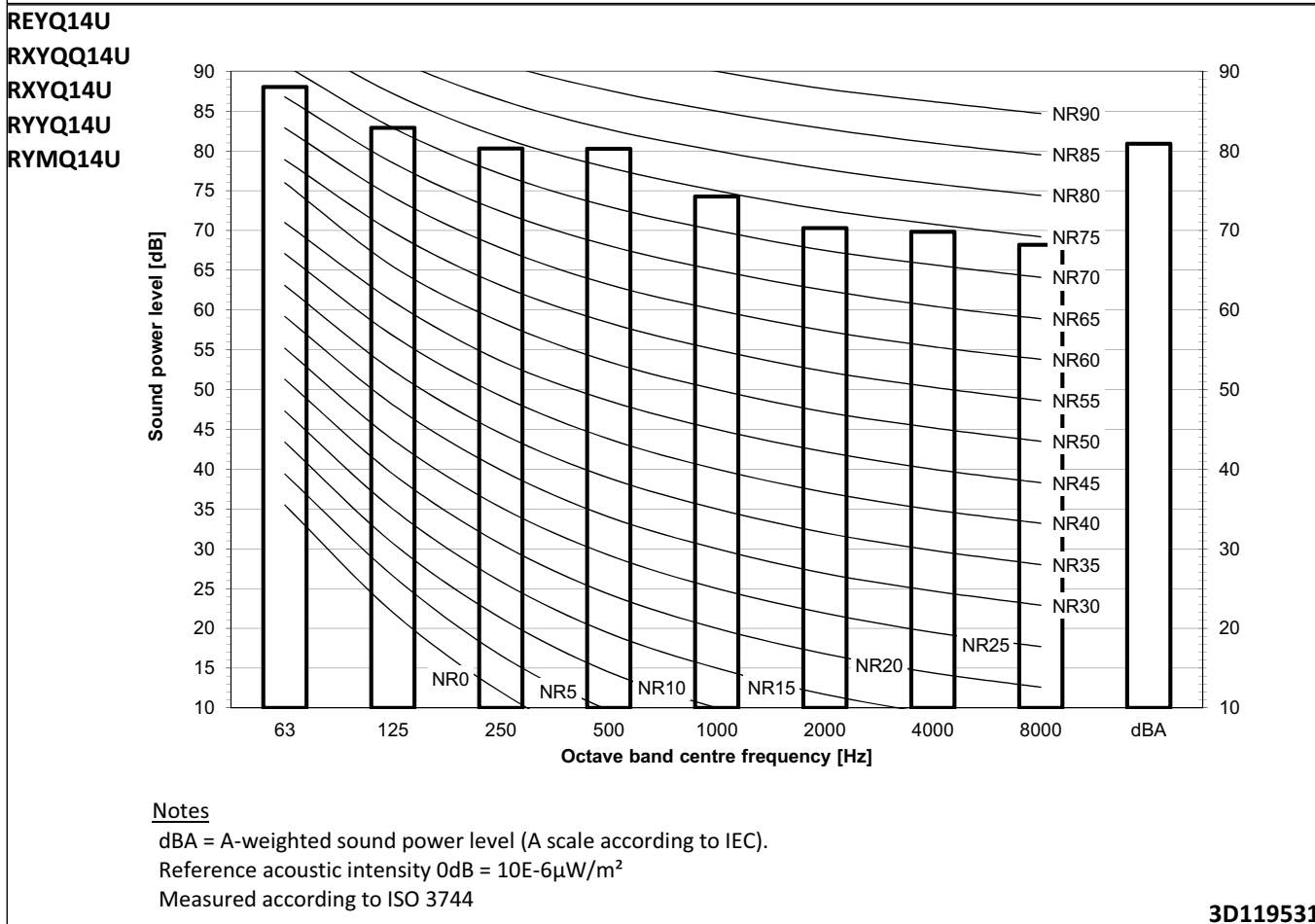

3D119531

11 Sound data

11 - 1 Sound Power Spectrum

11

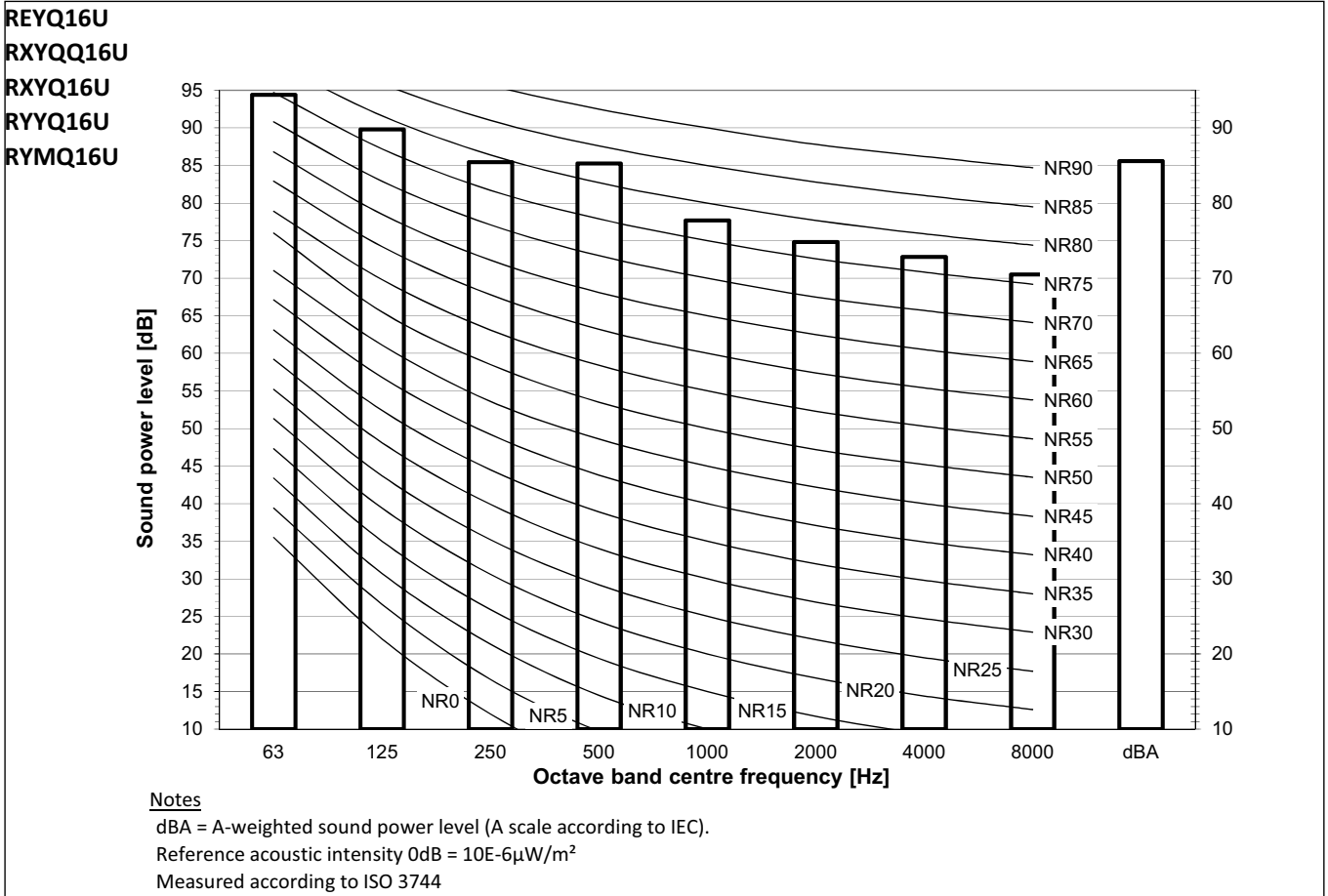

3D119532

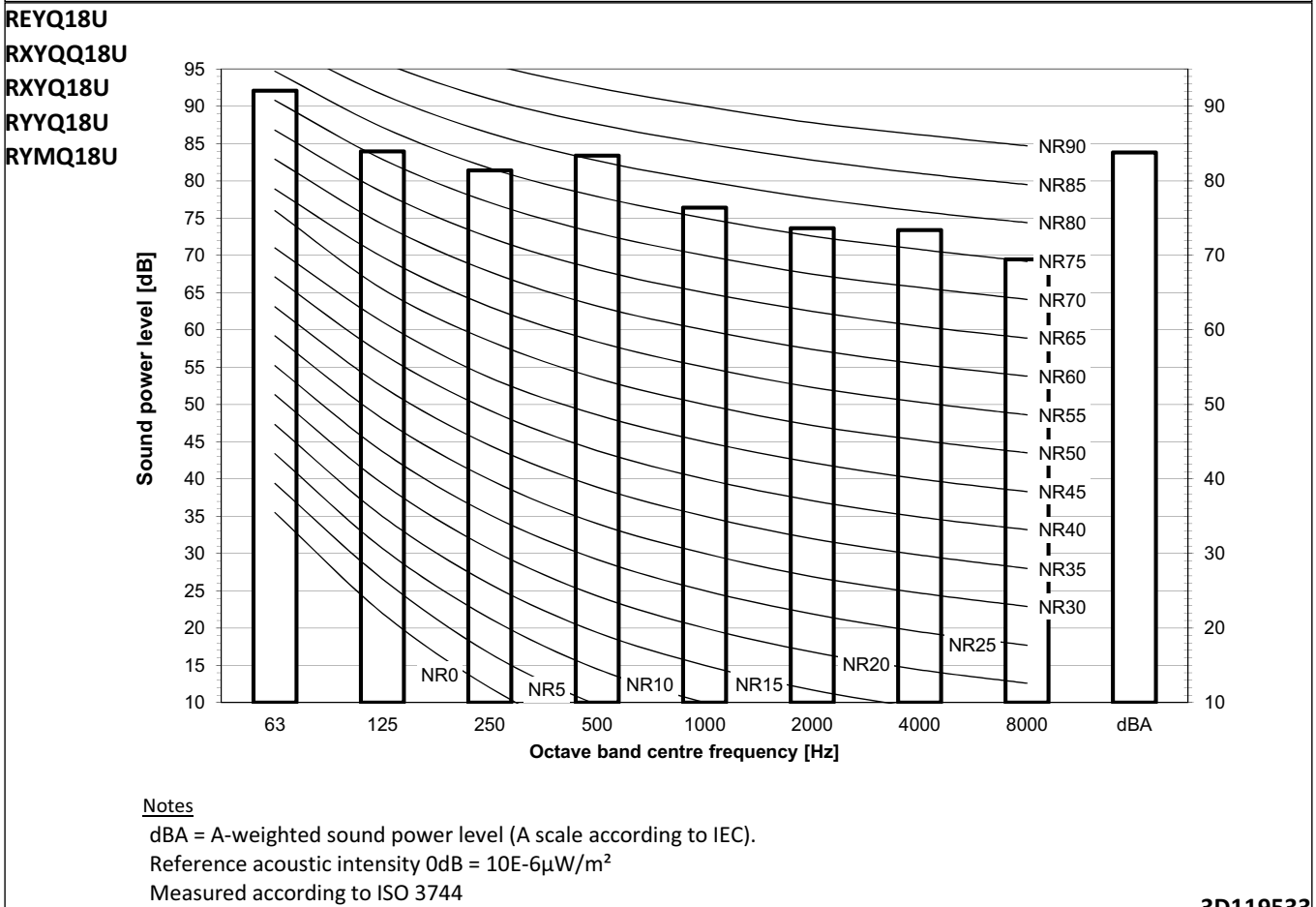

3D119533

11 Sound data

11 - 1 Sound Power Spectrum

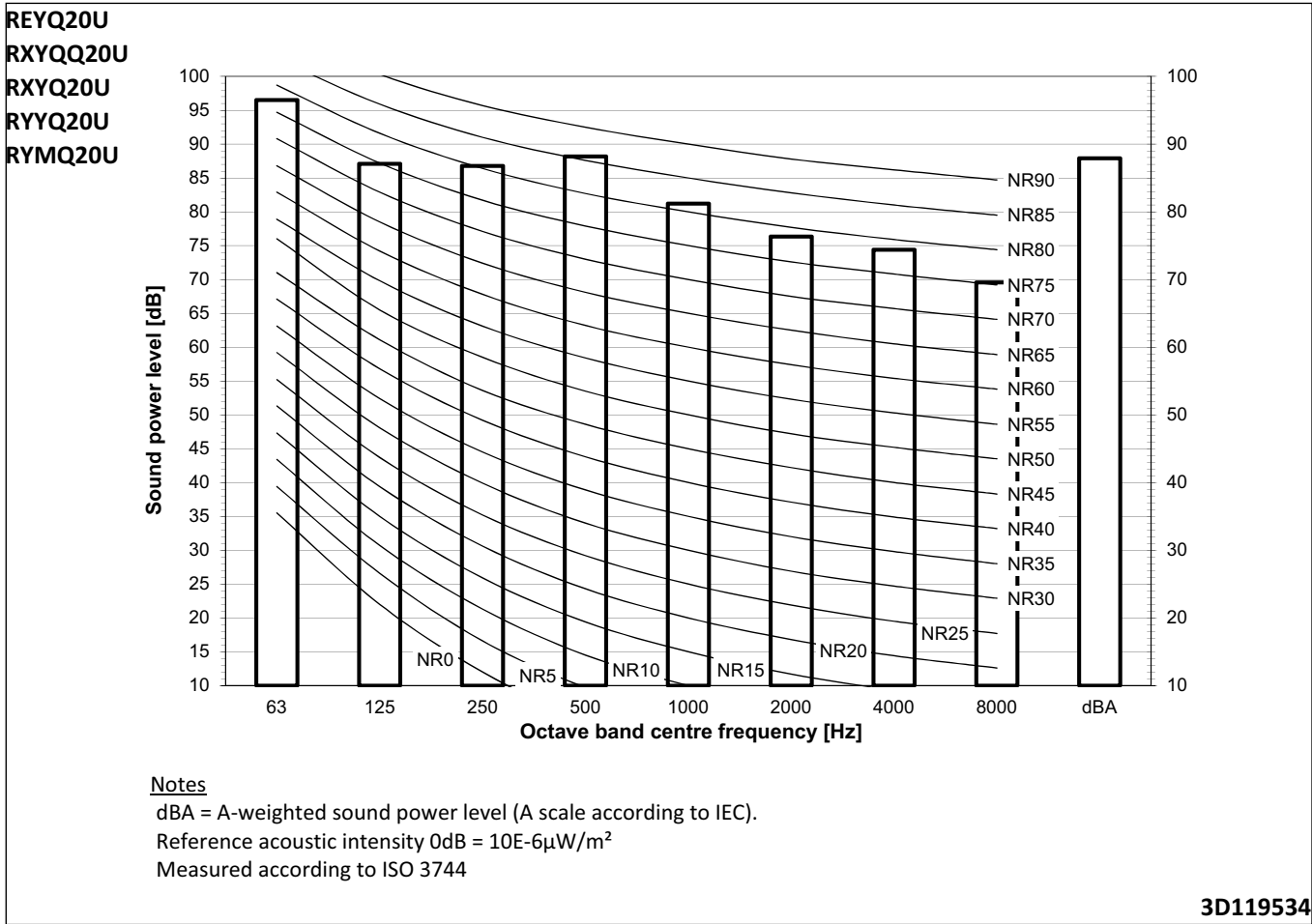

11 Sound data

11 - 2 Sound Pressure Spectrum

11

REMQ5U
REYQ8U
RXYQQ8U
RXYQ8U
RXYTQ8UYF
RYYQ8U
RYMQ8U

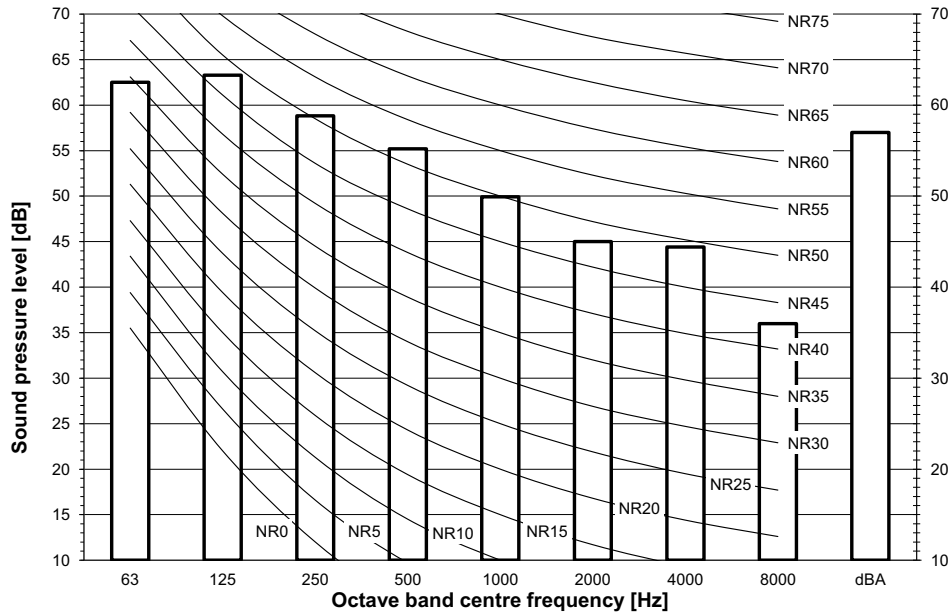

Notes

Data is valid at free field condition.
Data is valid at nominal operation condition.
dBA = A-weighted sound pressure level (A scale according to IEC).
Reference acoustic pressure 0 dB = 20 µPa

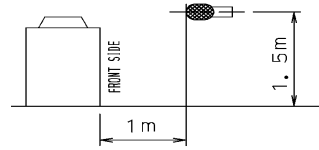

3D119521

REYQ10U
RXYQQ10U
RXYQ10U
RYYQ10U
RYMQ10U

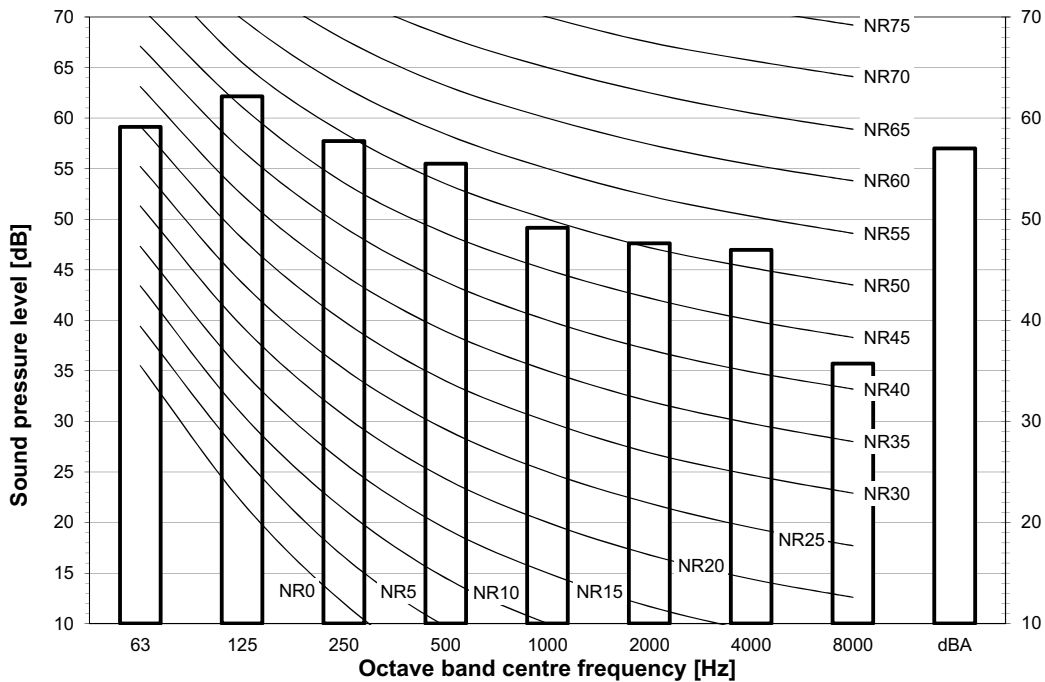

Notes

Data is valid at free field condition.
Data is valid at nominal operation condition.
dBA = A-weighted sound pressure level (A scale according to IEC).
Reference acoustic pressure 0 dB = 20 µPa

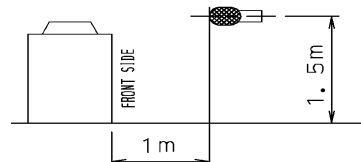

3D119522

11 Sound data

11 - 2 Sound Pressure Spectrum

REYQ12U
RXYQQ12U
RXYQ12U
RYYQ12U
RYMQ12U

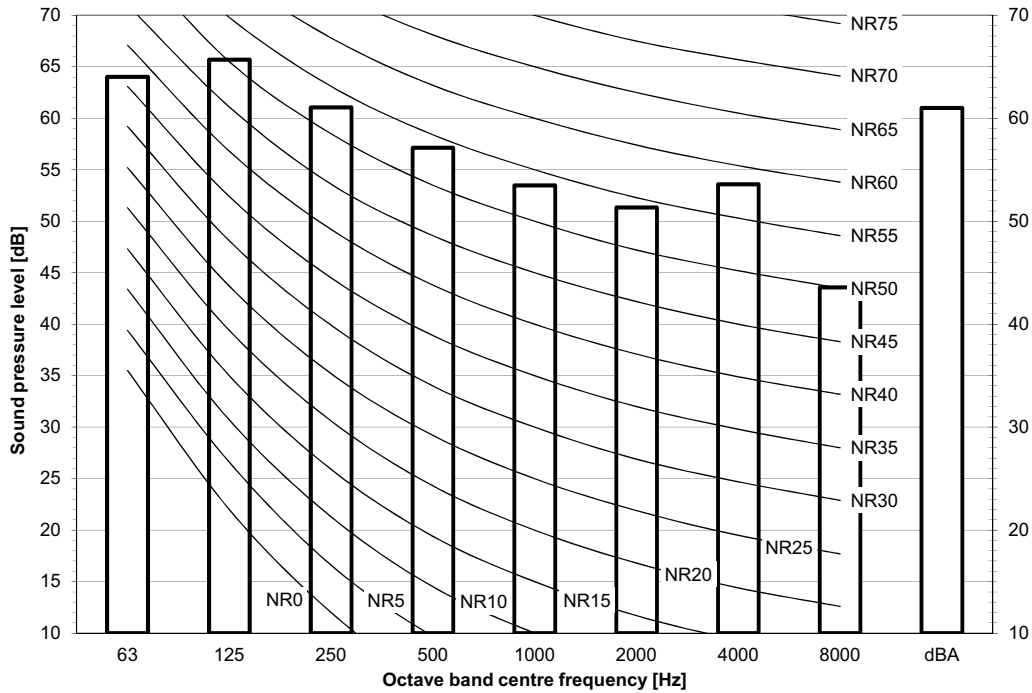

Notes

Data is valid at free field condition.
Data is valid at nominal operation condition.
dBA = A-weighted sound pressure level (A scale according to IEC).
Reference acoustic pressure 0 dB = 20 µPa

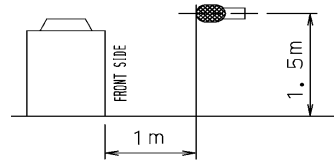

3D119523

REYQ14U
RXYQQ14U
RXYQ14U
RYYQ14U
RYMQ14U

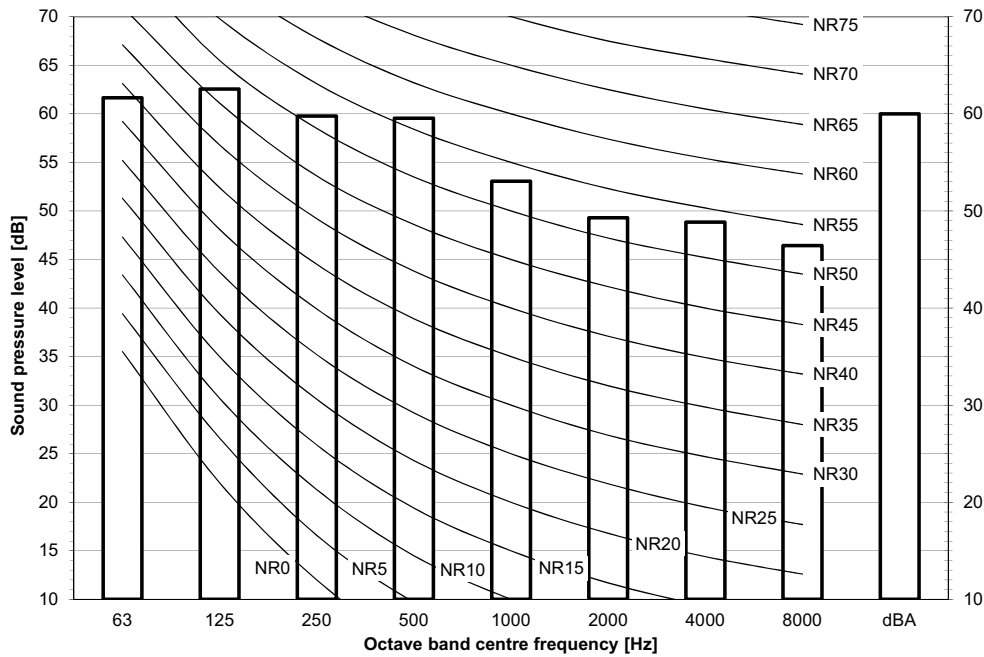

Notes

Data is valid at free field condition.
Data is valid at nominal operation condition.
dBA = A-weighted sound pressure level (A scale according to IEC).
Reference acoustic pressure 0 dB = 20 µPa

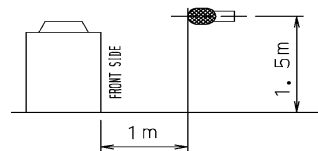

3D119524

11 Sound data

11 - 2 Sound Pressure Spectrum

11

REYQ16U
RXYQQ16U
RXYQ16U
RYYQ16U
RYMQ16U

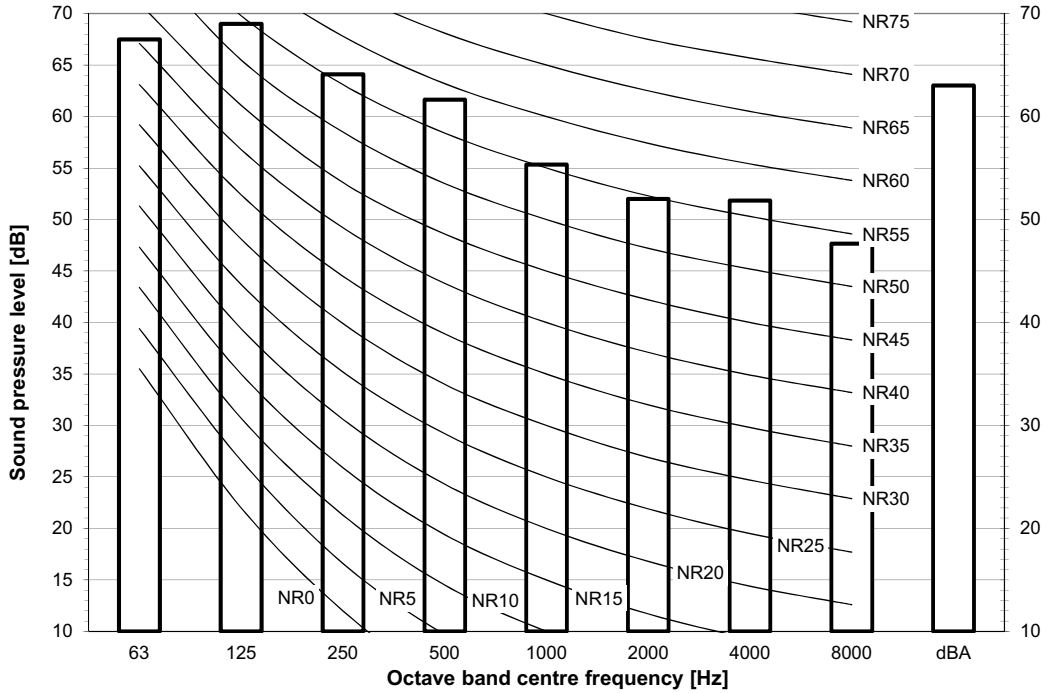

Notes

Data is valid at free field condition.
Data is valid at nominal operation condition.
dBA = A-weighted sound pressure level (A scale according to IEC).
Reference acoustic pressure 0 dB = 20 µPa

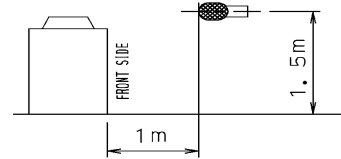

3D119525

REYQ18U
RXYQQ18U
RXYQ18U
RYYQ18U
RYMQ18U

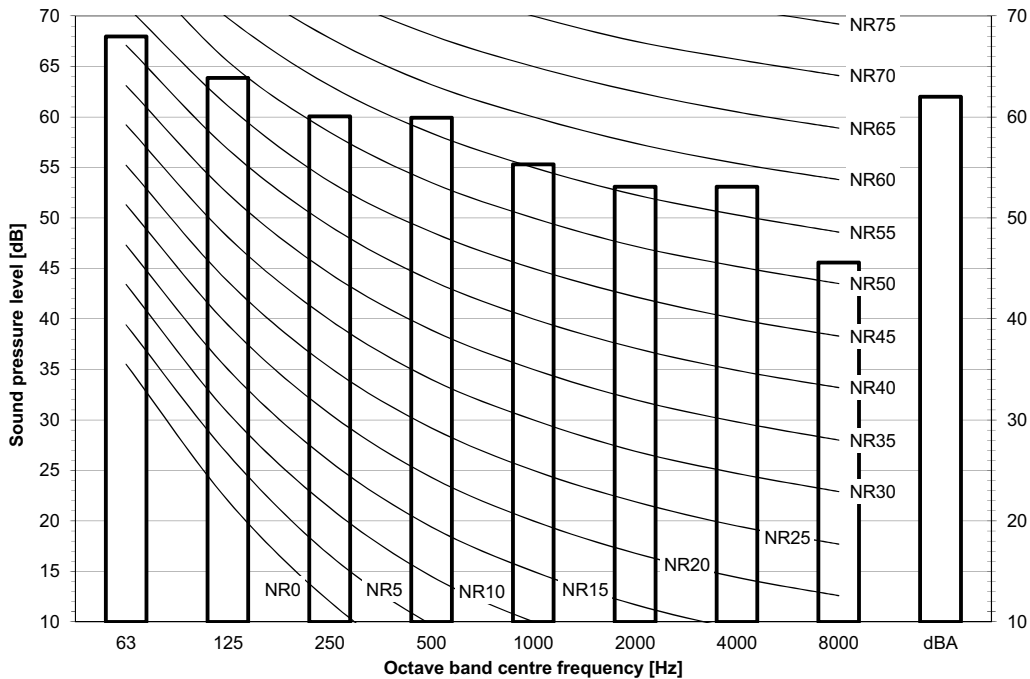

Notes

Data is valid at free field condition.
Data is valid at nominal operation condition.
dBA = A-weighted sound pressure level (A scale according to IEC).
Reference acoustic pressure 0 dB = 20 µPa

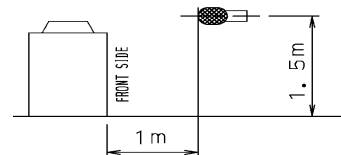

3D119526

11 Sound data

11 - 2 Sound Pressure Spectrum

REYQ20U
RXYQQ20U
RXYQ20U
RYYQ20U
RYMQ20U

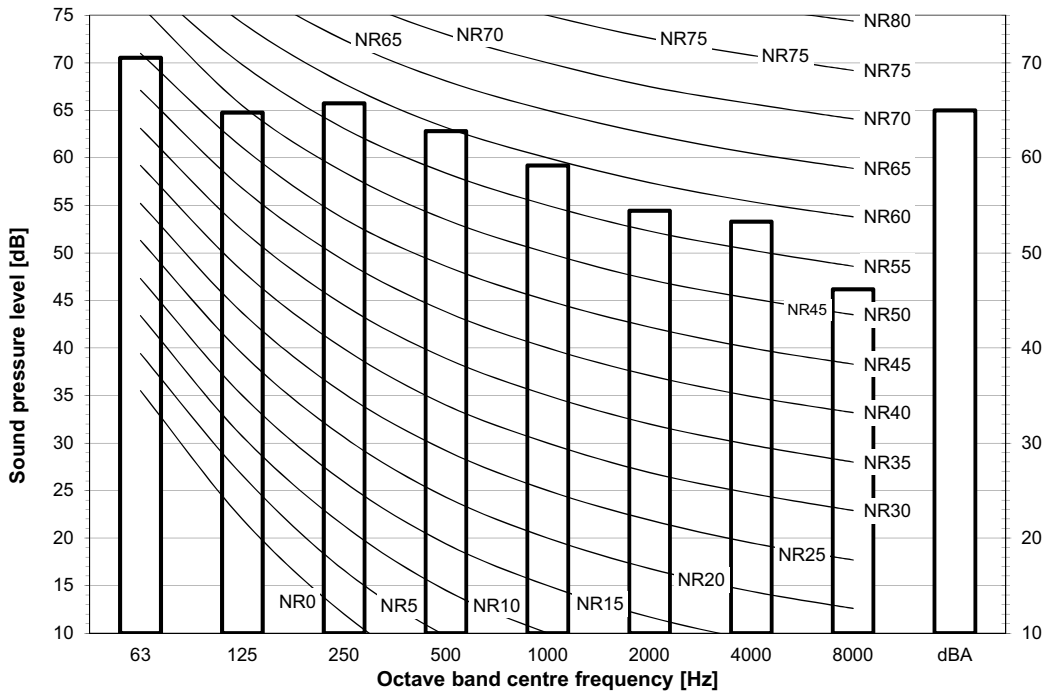

Notes

Data is valid at free field condition.
Data is valid at nominal operation condition.
dBA = A-weighted sound pressure level (A scale according to IEC).
Reference acoustic pressure 0 dB = 20 µPa

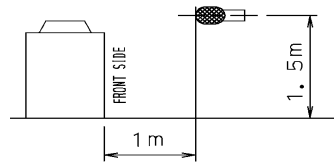

3D119527

11 Sound data

11 - 3 Sound Pressure Spectrum Quiet Mode

11

REMQ5U
REYQ8-12U
RXYQ8-12U
RXYQ8-12U
RXYTQ8UYF
RYY8-12U
RYMQ8-12U

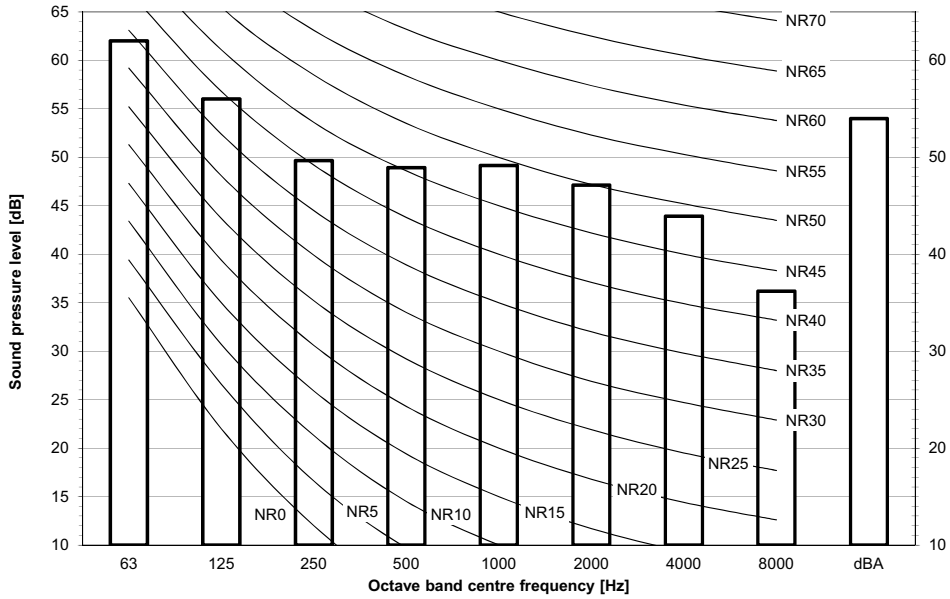

Notes
Data is valid at free field condition.
Data is valid at nominal operation condition.
dBA = A-weighted sound pressure level (A scale according to IEC).
Reference acoustic pressure 0 dB = 20 µPa
Data is valid under the following conditions
Cooling operation
Outdoor Ta: 35°C
Full load (maximum fan rps and maximum compressor rps for the dedicated low noise mode)

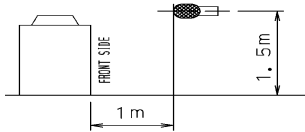

3D119535

REMQ5U
REYQ8-12U
RXYQ8-12U
RXYQ8-12U
RXYTQ8UYF
RYYQ8-12U
RYMQ8-12U

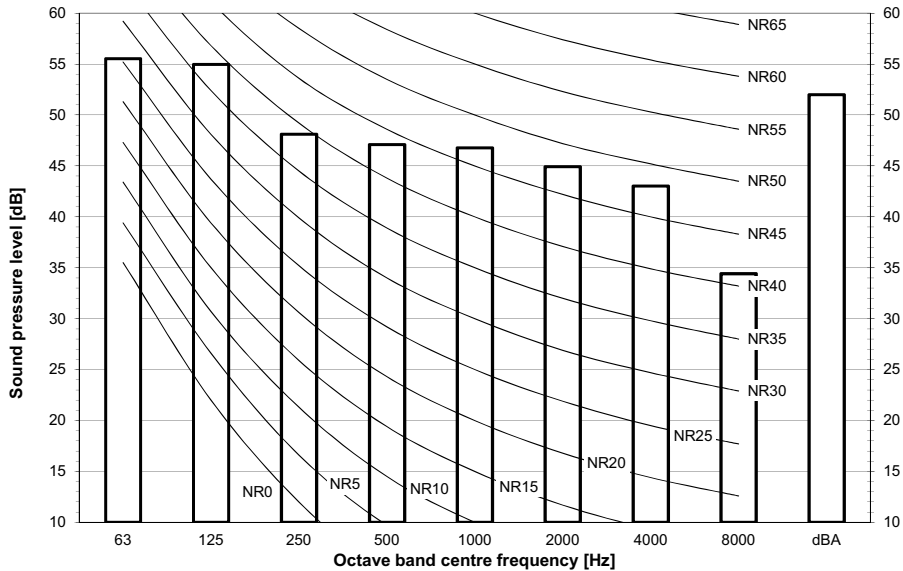

Notes
Data is valid at free field condition.
Data is valid at nominal operation condition.
dBA = A-weighted sound pressure level (A scale according to IEC).
Reference acoustic pressure 0 dB = 20 µPa
Data is valid under the following conditions
Cooling operation
Outdoor Ta: 35°C
Full load (maximum fan rps and maximum compressor rps for the dedicated low noise mode)

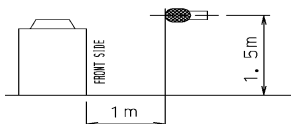

3D119536

11 Sound data

11 - 3 Sound Pressure Spectrum Quiet Mode

REMQ5U
 REYQ8-12U
 RXYQQ8-12U
 RXYQ8-12U
 RXYTQ8UYF
 RYYQ8-12U
 RYMQ8-12U

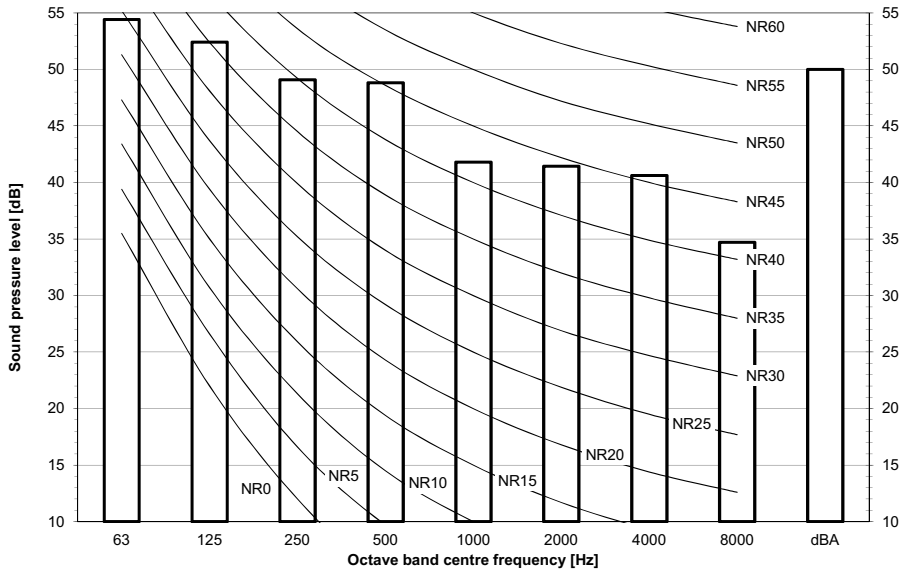

Notes
 Data is valid at free field condition.
 Data is valid at nominal operation condition.
 dBA = A-weighted sound pressure level (A scale according to IEC).
 Reference acoustic pressure 0 dB = 20 µPa
Data is valid under the following conditions
 Cooling operation
 Outdoor Ta: 35°C
 Full load (maximum fan rps and maximum compressor rps for the dedicated low noise mode)

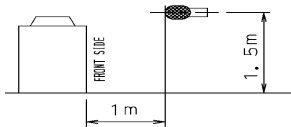

3D119537

REYQ14-16U
 RXYQQ14-16U
 RXYQ14-16U
 RXYTQ14-16UYF
 RYYQ14-16U
 RYMQ14-16U

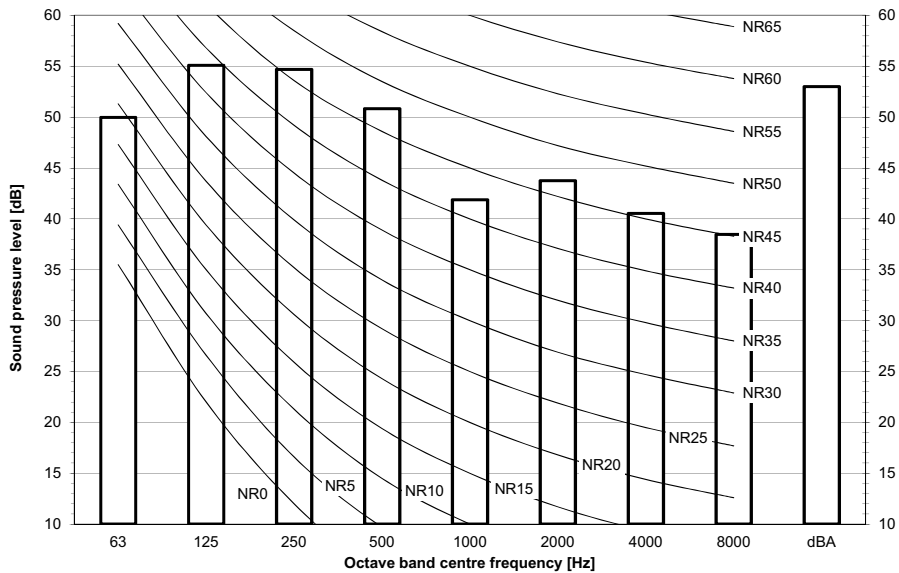

Notes
 Data is valid at free field condition.
 Data is valid at nominal operation condition.
 dBA = A-weighted sound pressure level (A scale according to IEC).
 Reference acoustic pressure 0 dB = 20 µPa
Data is valid under the following conditions
 Cooling operation
 Outdoor Ta: 35°C
 Full load (maximum fan rps and maximum compressor rps for the dedicated low noise mode)

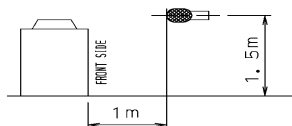

3D119538

11 Sound data

11 - 3 Sound Pressure Spectrum Quiet Mode

11

REYQ14-16U
 RXYQQ14-16U
 RXYQ14-16U
 RXYTQ14-16UYF
 RYYQ14-16U
 RYMQ14-16U

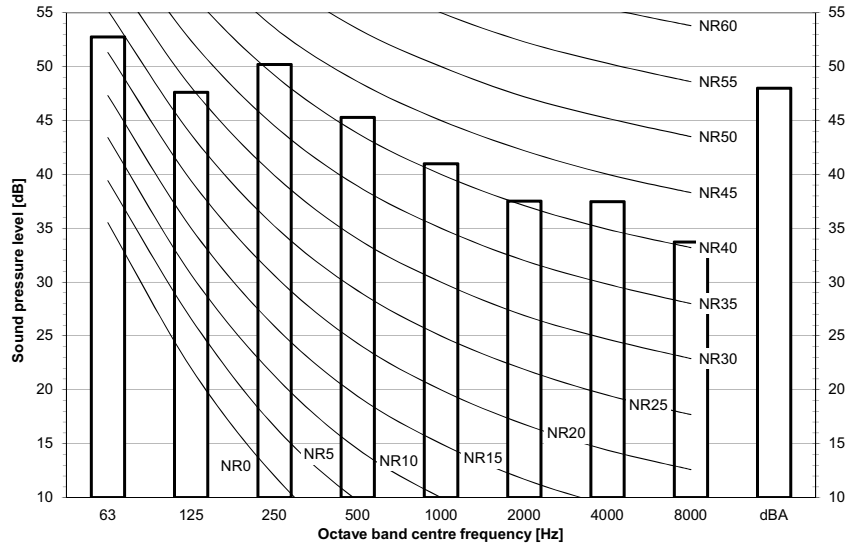

Notes
 Data is valid at free field condition.
 Data is valid at nominal operation condition.
 dBA = A-weighted sound pressure level (A scale according to IEC).
 Reference acoustic pressure 0 dB = 20 µPa
 Data is valid under the following conditions
 Cooling operation
 Outdoor Ta: 35°C
 Full load (maximum fan rps and maximum compressor rps for the dedicated low noise mode)

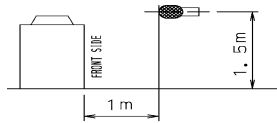

3D119539

REYQ14-16U
 RXYQQ14-16U
 RXYQ14U-16U
 RXYTQ14-16UYF
 RYYQ14-16U
 RYMQ14-16U

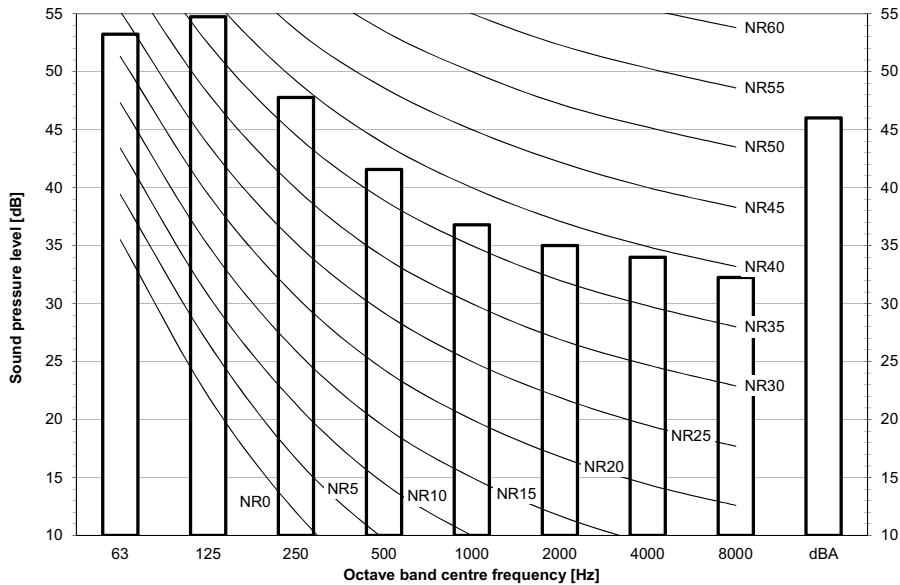

Notes
 Data is valid at free field condition.
 Data is valid at nominal operation condition.
 dBA = A-weighted sound pressure level (A scale according to IEC).
 Reference acoustic pressure 0 dB = 20 µPa
 Data is valid under the following conditions
 Cooling operation
 Outdoor Ta: 35°C
 Full load (maximum fan rps and maximum compressor rps for the dedicated low noise mode)

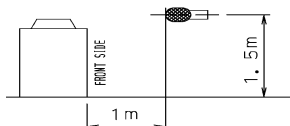

3D119540

11 Sound data

11 - 3 Sound Pressure Spectrum Quiet Mode

REYQ18-20U
 RXYQQ18-20U
 RXYQ18-20U
 RYYQ18-20U
 RYMQ18-20U

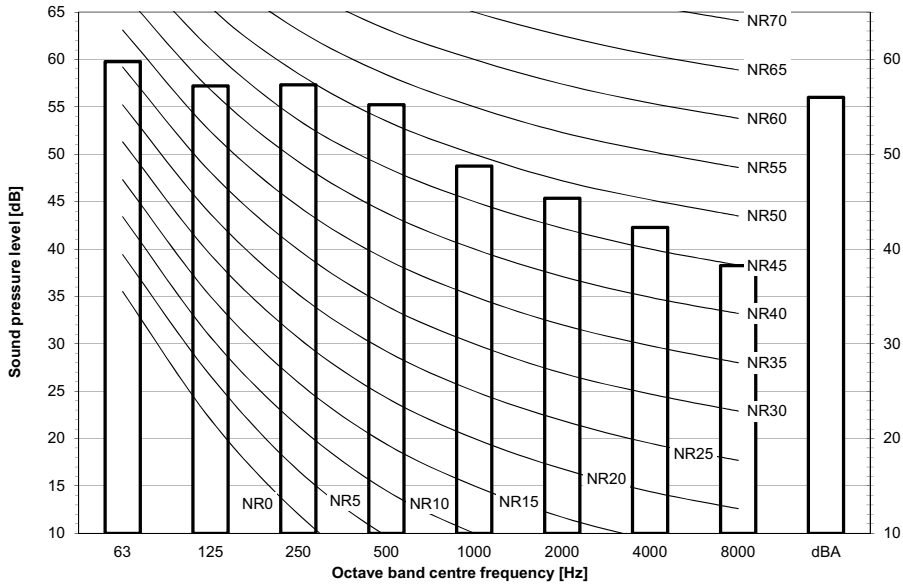

Notes
 Data is valid at free field condition.
 Data is valid at nominal operation condition.
 dBA = A-weighted sound pressure level (A scale according to IEC).
 Reference acoustic pressure 0 dB = 20 µPa
Data is valid under the following conditions
 Cooling operation
 Outdoor Ta: 35°C
 Full load (maximum fan rps and maximum compressor rps for the dedicated low noise mode)

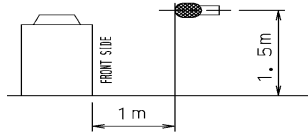

3D119541

REYQ18-20U
 RXYQQ18-20U
 RXYQ18-20U
 RYYQ18-20U
 RYMQ18-20U

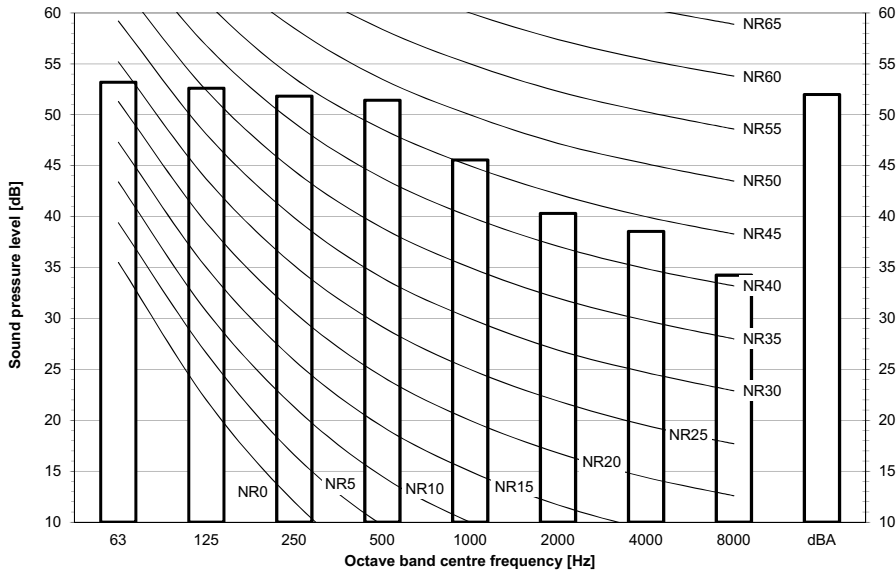

Notes
 Data is valid at free field condition.
 Data is valid at nominal operation condition.
 dBA = A-weighted sound pressure level (A scale according to IEC).
 Reference acoustic pressure 0 dB = 20 µPa
Data is valid under the following conditions
 Cooling operation
 Outdoor Ta: 35°C
 Full load (maximum fan rps and maximum compressor rps for the dedicated low noise mode)

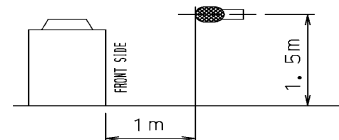

3D119542

11 Sound data

11 - 3 Sound Pressure Spectrum Quiet Mode

11

REYQ18-20U
 RXYQQ18-20U
 RXYQ18-20U
 RYYQ18-20U
 RYMQ18-20U

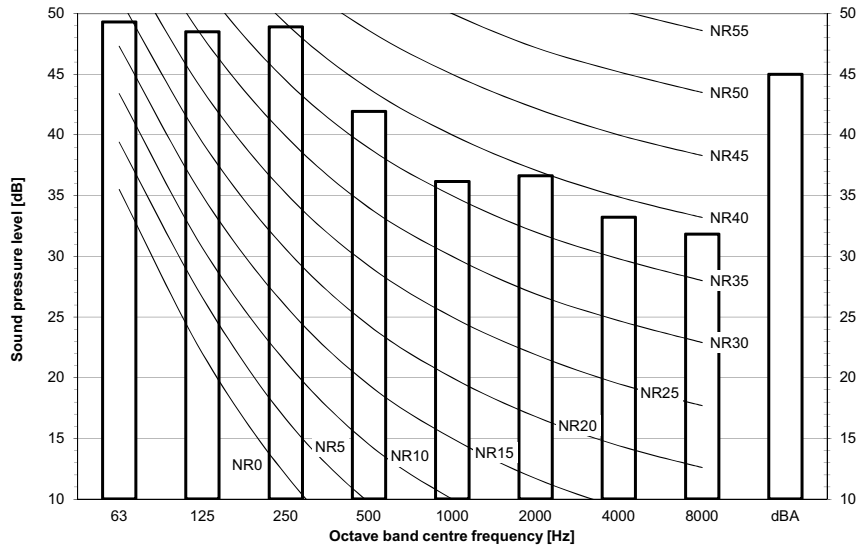

Notes
 Data is valid at free field condition.
 Data is valid at nominal operation condition.
 dBA = A-weighted sound pressure level (A scale according to IEC).
 Reference acoustic pressure 0 dB = 20 μPa
Data is valid under the following conditions
 Cooling operation
 Outdoor Ta: 35°C
 Full load (maximum fan rps and maximum compressor rps for the dedicated low noise mode)

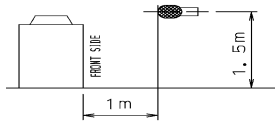

3D119543

12 Installation

12 - 1 Installation Method

REMQ5U
REYQ8-20U
RXYQ8-20U
RXYQ8-20U For single unit installation
RYYQ8-20U
RYMQ-20U

For installation in rows

For centralised group layout

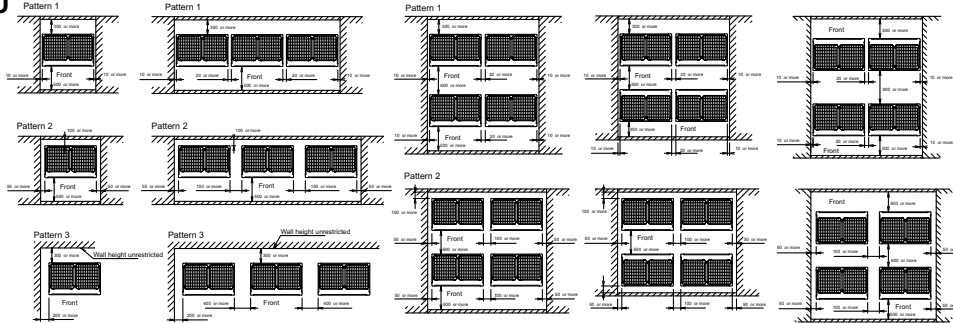

Notes

1. Height of the walls in case of patterns 1 and 2:

- Front: 1500mm
- Suction side: 500mm
- Side: height unrestricted

The installation space shown on this drawing is based on cooling operation at 35°C (outdoor temperature).

When the design outdoor ambient temperature exceeds 35°C or the load exceeds maximum ability of much generation load of heat in all outdoor unit, make sure the suction-side space is broader than the space shown on this drawing.

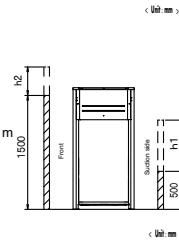

2. If the walls are higher than mentioned above, then additional service space is needed:

- suction side: service space + $h1/2$
- front side: service space + $h2/2$

3. When installing the units, select the pattern that best fits the available space.

Always keep in mind to leave sufficient space for a person to pass between unit and wall and for the air to circulate freely.

If more units are to be installed than are catered for in the above patterns, your layout should take into account of the possibility of short circuits.

4. Provide sufficient space at the front to connect refrigerant piping (comfortably).

3D118467

12 Installation

12 - 2 Fixation and Foundation of Units

12

REMQ5U
REYQ8-20U
RXYQ8-20U
RXYQ8-20U
RXYTQ8-16UYF
RYYQ8-20U
RYMQ8-20U

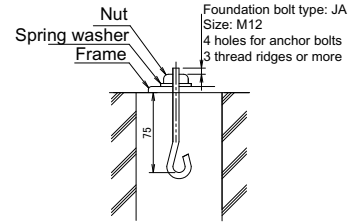
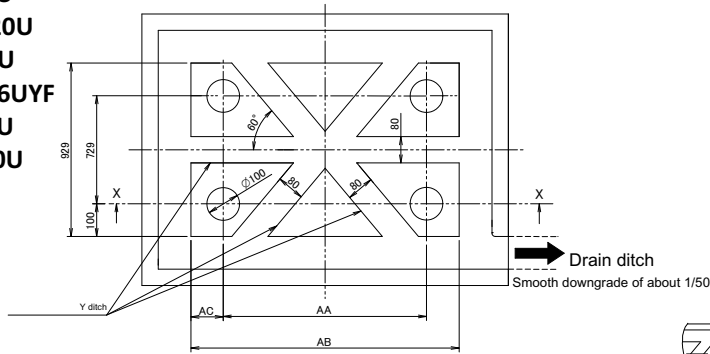

Foundation bolt fixing method

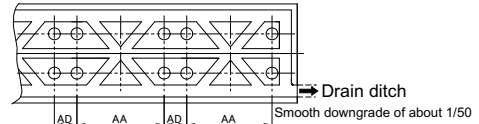

When building a foundation on the ground ↔ When building a foundation on a concrete floor

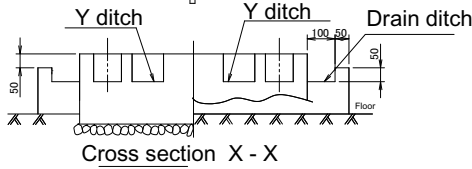

For multi-unit installation

Model	AA	AB	AC	AD
RYYQ8-12U	766	992	113	185
RYMQ8-12U				
RXYQ8-12U				
RXYQ8-12U				
REMQ5T/REYQ8-12U				
RXYTQ8U				
RYYQ14-20U	1076	1076	113	185
RYMQ14-20U				
RXYQ14-20U				
RXYQ14-20U				
RXYTQ10-16U				

Notes

1. Provide a drain ditch around the foundation to drain water from the installation area.
2. The surface has to be finished with mortar. The corner edges have to be chamfered.
3. Build the foundation on a concrete floor or, if not possible, make sure the foundation surface has a rough finish.
4. Use a cement/sand/gravel ratio of 1/2/4 for the concrete, and a diameter of 10 mm for the reinforcement bars (approximately, 300mm intervals).
5. When installing the equipment on a roof, make sure to check the strength of the floor and take adequate water proofing measures. **3D118459**

12 Installation

12 - 3 Refrigerant Pipe Selection

RXYQ-U
RYYQ-Y
RYMQ-U

VRV4
Heat pump
Piping restrictions 1/3

For the reference drawing, see page 2/3.

	Maximum piping length			Maximum height difference			Total piping length
	Longest pipe (A+[B,G,E,J]) Actual / (Equivalent)	After first branch (B,G,E,J) Actual	After first branch (for multi-outdoor) (D) Actual / (Equivalent)	Indoor-to-outdoor ⁽³⁾ (H1) Outdoor above indoor / (indoor above outdoor)	Indoor-to-indoor (H2)	Outdoor-to-outdoor (H3)	
Standard							
<i>VRV DX indoor units only</i>	165/(190)m	40m ⁽¹⁾	10/(13)m	50/(40)m ⁽³⁾	30m	5m	1000m
<i>Standard multi-combination</i>							
<i>All multi-outdoor-unit combinations except standard multi-outdoor-unit combinations</i>	135/(160)m	40m ⁽¹⁾	10/(13)m	50/(40)m ⁽³⁾	30m	5m	500m
Hydrobox connection	135/(160)m	40m	10/(13)m	50/(40)m	15m	5m	300-500m ⁽⁵⁾
RA connection	100/(120)m	50m ⁽²⁾	-	50/(40)m	15m	-	250m
AHU connection	Pair	50/(55)m ⁽⁴⁾	-	40/(40)m	-	-	-
	Multi ⁽⁶⁾	165/(190)m	40m	10/13m	40/(40)m	15m	5m
	Mix ⁽⁷⁾	165/(190)m	40m	10/13m	40/(40)m	15m	5m

Remark

For standard multi-outdoor-unit combinations, see 3D079534.

- (1) If all conditions below are met, the limitation can be extended up to 90 m
 - a. The piping length between all indoor units and the nearest branch kit is ≤ 40m.
 - b. It is necessary to increase the size of the gas and liquid piping if the pipe length between the first and the farthest indoor unit is >40m.
 - If the increased pipe size is larger than the pipe size of the main pipe, also increase the size of the main pipe.
 - c. When the piping size is increased, the piping length has to be counted as double.
 - The total piping length has to be within limitations.
 - d. The piping length difference between the nearest indoor unit from the first branch to the outdoor unit and the farthest indoor unit to the outdoor unit is ≤ 40m.
- (2) If the piping length between the first branch and the BP box or VRV indoor unit is more than 20m, increase the length of the gas and liquid piping between the first branch and the BP box or VRV indoor unit.
- (3) An extension to up to 90 m is possible without an additional option kit. Respect the following conditions:
 - > If the outdoor units are positioned higher than the indoor units:
 - a. Size up the liquid piping
 - b. A dedicated setting on the outdoor unit is required.
 - > If the outdoor units are positioned lower than the indoor units:
 - a. 40~60m Minimum connection ratio: 80%
 - 60~65m Minimum connection ratio: 90%
 - 65~80m Minimum connection ratio: 100%
 - 80~90m Minimum connection ratio: 110%
 - b. Size up the liquid piping
 - A dedicated setting on the outdoor unit is required.
- (4) The allowable minimum length is 5 m.
- (5) In case of multi-outdoor-unit combinations.
- (6) Multiple air handling units (AHU)(EKEXV + EKEQ kits).
- (7) Mix of AHU units and VRV DX indoor
- (8) If the equivalent piping length between is > 90m, size up the main liquid and gas piping.

3D079540E

12 Installation

12 - 3 Refrigerant Pipe Selection

12

RXYQ-U
RYYQ-U
RYMQ-U

VRV4
Heat pump
Piping restrictions 2/3

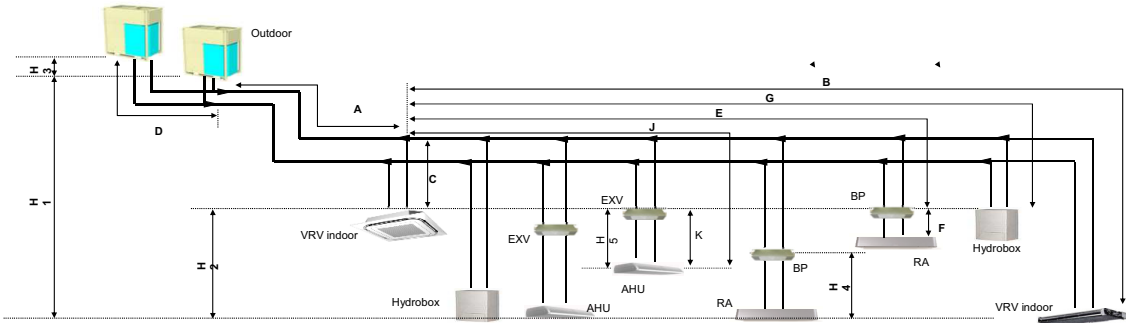

Remark

- (1) Schematic indication
Illustrations may differ from the actual appearance of the unit.
- (2) This is only to illustrate piping length limitations.
Combination of indoor unit types is not allowed.
Refer to combination table 3D079543 for details about the allowed combinations.

	Allowed piping length		Maximum height difference	
	BP to RA (F)	EXV to AHU (K)	BP to RA (H4)	EXV to AHU (H5)
	RA connection	2~15m	-	5m
AHU connection	Pair	≤5m	-	5m
	Multi ⁽¹⁾	≤5m	-	5m
	Mix ⁽²⁾	≤5m	-	5m

Remark

- (1) Multiple air handling units (AHU)(EKEVX + EKEQ kits).
- (2) Mix of AHU units and VRV DX indoor

3D079540E

12 Installation

12 - 3 Refrigerant Pipe Selection

RXYQ-U
RYYQ-U
RYMQ-U

VRV4
Heat pump
Piping restrictions 3/3

System pattern Allowed connection ratio (CR) Other combinations are not allowed.	Total		Allowed capacity			
	Capacity	Indoor unit quantity (VRV, RA, AHU, Hydrobox)	VRV DX indoor unit	RA DX indoor unit	Hydrobox unit	Air handling unit (AHU)
VRV DX indoor units only	50~130%	Max.64	50~130%	-	-	-
VRV DX indoor unit + RA DX	80~130%	Max.32 ⁽¹⁾	0~130%	0~130%	-	-
RA DX indoor unit	80~130%	Max.32 ⁽¹⁾	-	80~130%	-	-
VRV DX indoor unit + LT hydrobox	50~130%	Max.32	50~130%	-	0~80%	-
VRV DX indoor unit + AHU	50~110% ⁽³⁾	Max.64 ⁽²⁾	50~110%	-	-	0~110%
AHU only Pair + multi (4)	90~110% ⁽³⁾	Max.64 ⁽²⁾	-	-	-	90~110%

Remark

- (1) There is no restriction on the number of connectable BP boxes.
- (2) For connection with AHU
EKEXV kits are also considered indoor units.
- (3) Restrictions regarding the air handling unit capacity
- (4) Pair AHU = system with 1 air handling unit connected to one outdoor unit
Multi AHU = system with multiple air handling units connected to one outdoor unit

About ventilation applications

- I. FXMQ_MF units are considered air handling units, following air handling unit limitations.
Maximum connection ratio when combined with VRV DX indoor units: <30%.
Maximum connection ratio when only air handling units are connected: <100%.
For information on the operation range, refer to the documentation of the FXMQ_MF unit.
- II. Biddle air curtains are considered air handling units, following air handling unit limitations:
For information on the operation range, refer to the documentation of the Biddle unit.
- III. [EKEXV + EKEQ] units combined with an air handling unit are considered air handling units, following air handling unit limitations.
For information on the operation range, refer to the documentation of the EKEXV-EKEQ unit.
- IV. VKM units are considered to be regular VRV DX indoor units.
For information on the operation range, refer to the documentation of the VKM unit.
- V. Because there is no refrigerant connection with the outdoor unit (only communication F1/F2), VAM units do not have connection limitations.
However, since there is communication via F1/F2, count them as regular indoor unit when calculating the maximum allowed number of connectable indoor units.

13 Operation range

13 - 1 Operation Range

13

RXYQQ-U
RXYQ-U
RYYQ-U
RYMQ-U

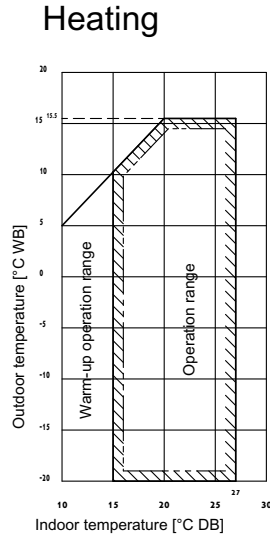
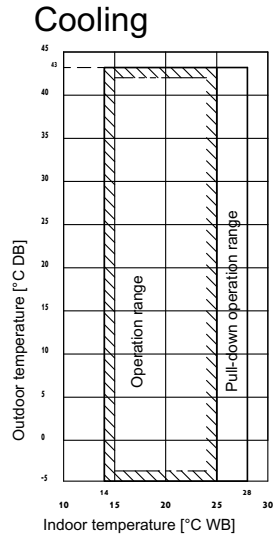

Notes

1. These figures assume the following operation conditions

Indoor and outdoor units
Equivalent piping length: 5m
Level difference: 0m

- 2. Depending on operation and installation conditions, the indoor unit can change over to freeze-up operation (indoor de-icing).
- 3. To reduce the freeze-up operation (indoor de-icing) frequency, it is recommended to install the outdoor unit in a location not exposed to wind.
- 4. Operation range is valid in case direct expansion indoor units are used.

3D118465

14 Appropriate Indoors

14 - 1 Appropriate Indoors

RYYQ-U

RYMQ-U

RXYQ-U

Recommended indoor units for ·RXYQ*U* / RYYQ*U* / RYMQ*U*· outdoor units

HP	8	10	12	14	16	18	20
	4xFXMQ50	4xFXMQ63	6xFXMQ50	1xFXMQ50 5xFXMQ63	4xFXMQ63 2xFXMQ80	3xFXMQ50 5xFXMQ63	2xFXMQ50 6xFXMQ63

For multi outdoor units >16HP, the recommended amount of indoor units is the sum of the indoor units defined for a single outdoor unit.
For details about the allowed combinations, see the engineering databook.

Appropriate indoor units for ·RXYQ*U* / RYYQ*U* / RYMQ*U*· outdoor units

Covered by ·ENER LOT21·

FXFQ20-25-32-40-50-63-80-100-125
 FXZQ15-20-25-32-40-50
 FXCQ20-25-32-40-50-63-80-125
 FXKQ25-32-40-63
 FXDQ15-20-25-32-40-50-63
 FXSQ15-20-25-32-40-50-63-80-100-125-140
 FXMQ50-63-80-100-125-200-250
 FXAQ15-20-25-32-40-50-63
 FXHQ32-63-100
 FXUQ71-100
 FXNQ20-25-32-40-50-63
 FXLQ20-25-32-40-50-63

Covered by ·ENER LOT10·

FTXJ25-35-50
 FTXM20-25-35-42-50-60-71
 CTXM15
 FLXS25-35-50-60
 FVXM25-35-50
 FVXG25-35-50

Outside the scope of ·ENER LOT21·

EKEXV50-63-80-100-125-140-200-250-400-500 + EKEQM / EKEQF
 HXY080-125
 VKM50-80-100
 CYVS100-150-200-250
 CYVM100-150-200-250
 CYVL100-150-200-250

3D118461



Daikin Europe N.V. Naamloze Vennootschap - Zandvoordestraat 300, B-8400 Oostende - Belgium - www.daikin.eu - BE 0412 120 336 - RPR Oostende

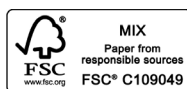
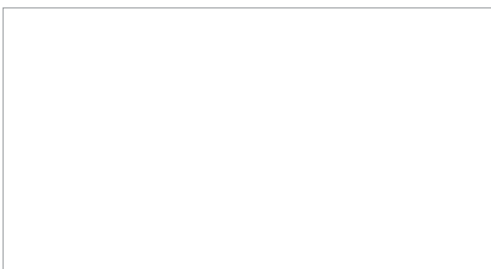

EEDEN19 02/19



The present leaflet is drawn up by way of information only and does not constitute an offer binding upon Daikin Europe N.V.. Daikin Europe N.V. has compiled the content of this leaflet to the best of its knowledge. No express or implied warranty is given for the completeness, accuracy, reliability or fitness for particular purpose of its content and the products and services presented therein. Specifications are subject to change without prior notice. Daikin Europe N.V. explicitly rejects any liability for any direct or indirect damage, in the broadest sense, arising from or related to the use and/or interpretation of this leaflet. All content is copyrighted by Daikin Europe N.V.