

# VRV

Product catalogue 2019  
for professionals

Includes  
**NEW VRV IV+**  
ranges!

Minimum running costs,  
maximum flexibility.  
Fast installation, top reliability,  
perfect comfort.

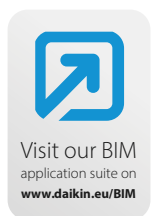

# VRV

ready for the future

**+**  
Seasonal  
Efficiency

**+**  
Refrigerant  
Reuse

**-**  
GWP  
Refrigerants

**-**  
Refrigerant  
Quantity

Striving to be  
the lowest CO<sub>2</sub> equivalent manufacturer

**Introducing the next generation VRV**

- › CO<sub>2</sub> equivalent reductions thanks to the use of lower GWP refrigerant
- › Breakthrough technologies reducing refrigerant charges
- › Facilitating circular economy of refrigerants, encouraging reuse
- › Achieve sustainability over the entire lifecycle thanks to market leading efficiencies
- › To be launched in 2019

[www.daikin.eu](http://www.daikin.eu)





# VRV



The solution for any commercial application, no matter the size.

## Table of contents

	VRV IV, sets the standard... again	4	
	VRV IV+ standard & technologies	18	
	Benefits	26	
	Outdoor units	36	
	Indoor units	97	
	Hot water	132	
	Biddle Air Curtains	139	
	Ventilation and Air Handling	142	
	Control Systems	161	
	Options and Accessories	190	
	Tools and platforms	202	

# VRV IV sets the standard ... again



## 9 reasons why VRV is unique in the market

### 1 Efficiency

- › Variable Refrigerant Temperature for high seasonal efficiency
- › Round flow cassette and concealed ceiling units with auto cleaning filter
- › The best partner for your "green" project
  - A team of AP's across Europe who are there to help you
  - Daikin is the 1st HVAC-R manufacturer to achieve BES6001 certificates gaining additional BREEAM credits

### 2 Comfort

- › Variable Refrigerant Temperature preventing cold draughts in cooling thanks to high outblow temperatures
- › True continuous heating during defrost
- › Low sound indoor and outdoor units
- › Presence and floor sensors direct the air flow away from persons, while ensuring an even temperature distribution
- › Round flow cassette and concealed ceiling units with auto cleaning filter ensure optimum air quality

### 3 Reliability

- › True technical cooling
- › Refrigerant cooled PCB
- › Most extensive testing before new units leave the factory
- › Widest sales support network and after sales service
- › All spare parts available in Europe
- › Preventive maintenance via i-Net
- › Round flow cassette and concealed ceiling units with auto cleaning filter further enhance reliability by extending smooth and trouble free operation due to clean air-filters

### 4 Design

- › Fully flat cassette, fully integrated in the ceiling
- NEW** › Widest ever range of cassette panels
  - Available in **white and black**
  - Sleek **designer panel** range
- › Daikin Emura, unique iconic design

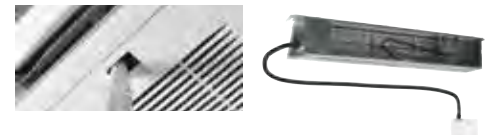
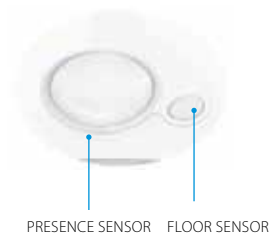

FULLY FLAT CASSETTE



DAIKIN EMURA

## 5 Controls

A new, sleek wired controller designed to enhance the user experience

- › Intuitive touch button control
- › 3 color versions (White, Silver, Black)
- › Advanced settings and commissioning via smartphone or tablet



BRC1H519W(7)



- › Intelligent Touch manager: A cost-effective mini BMS integrating all Daikin products
- › Easy integration in third party BMS via BACnet, LonWorks, Modbus, KNX
- › Dedicated control solutions for applications such as technical cooling, shops, hotels, ...

**NEW**

- › Daikin Cloud Service offers services such as online control, energy monitoring, comparison of multiple sites and predictive maintenance for a long and trouble free operation



## 6 Installation

- › Automatic refrigerant charge and refrigerant containment check
- › 4-way blow ceiling suspended cassette (FXUQ)
- › Plug & play Daikin Air Handling Unit
- › Total solution including low and high temperature hydro box, Biddle air curtains
- › VRV configurator software for the fastest commissioning, configuration and customisation
- › Outdoor unit display for quick on-site settings and detailed error readouts for improved customer support



FXUQ



7-segment display

## 7 Inventor

- › Market leader of VRV systems since 1982
- › Over 90 years of expertise in heat pump technology
- › Designed for and produced in Europe



## 8 Range

- › Unique outdoor unit range, with dedicated series for different applications and climate conditions

## 9 Technology

### Variable refrigerant temperature

- › Seasonal efficiency increased by 28%
- › The first weather accommodating control on the market
- › Customer comfort is assured thanks to higher outdoor temperatures (preventing cold draughts)



### Continuous heating

- › Real continuous heating providing heating even during defrost
- › Continuous indoor comfort ensured by the heat accumulating element or alternate defrost
- › An innovative alternative to traditional heating systems, enabling heat pumps to be used as monovalent heating source systems



Heat pump  
Heat recovery  
Replacement  
Water cooled



### VRV configurator

- › Software for simplified commissioning, configuration and customisation
- › Graphical interface
- › Manage systems over multiple sites in exactly the same way
- › Retrieve initial settings

## Your known VRV IV with increased seasonal efficiency according to LOT21



VRV IV+ series are available in heat recovery, heat pump, replacement and high ambient versions



Already fully compliant to LOT 21 - Tier 2

### Increase of seasonal efficiency up to 23%!

- ✓ Measured with indoor units for real applications!
- ✓ ALL information for indoor units used available on our eco-design website: [https://energylabel.daikin.eu/en\\_US/lot21.html](https://energylabel.daikin.eu/en_US/lot21.html)



### New scroll compressor with increased efficiencies at partial loads

### Total solution

- ✓ Connects to ventilaton, hot water and Biddle air curtains
- ✓ Combines stylish with standard VRV indoor units

### The known VRV IV standards

- ✓ Variable Refrigerant Temperature
- ✓ Continuous heating during defrost
- ✓ VRV configurator
- ✓ 4-side heat exchanger



New VRV IV C<sup>+</sup> series,  
designed for even  
the coldest regions



### High heating capacity at low ambient temperatures

- ☑ Stable heating capacity available down to -15°C WB!



### High reliability down to -25°C WB

- ☑ Hot gas bypass prevents ice buildup at the bottom of the heat exchanger



Already fully compliant  
to LOT 21 - Tier 2

### High partial load efficiency

- ☑ New vapour injection scroll compressor optimised for low part load
- ☑ Variable Refrigerant Temperature adjusts refrigerant temperature to match the load
- ☑ Measured with indoor units for real applications!

### Total solution

- ☑ Connects to ventilaton, hot water and Biddle air curtains
- ☑ Combines stylish with standard VRV indoor units



### The known VRV IV standards

- ☑ Variable Refrigerant Temperature
- ☑ VRV configurator



The most comfortable cassette  
**just got better**

## New round flow cassette



- › **Bigger flaps** and **new sensor logic** further improves equal air distribution in the room
- › **Widest ever choice in panels** for cassette units, with up to 8 different panels

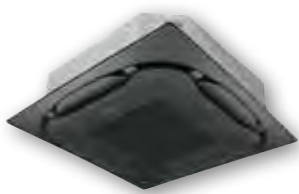

Black auto cleaning panel

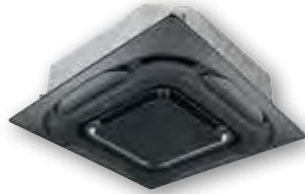

Black designer panel



Full white standard panel



White designer panel

- › Comes with the known benefits: **360° air flow discharge** and **intelligent sensors**



presence sensor floor sensor

- › **Auto cleaning** panels available in black and white



### Auto cleaning filter

Dust can simply be removed using a vacuum cleaner without opening the unit.

\* Available as an option





## Measuring "real life" efficiencies

# Eco design directive for energy related products (ErP – ENER LOT21)

## What is ENER LOT21?

- ✓ Applicable for commercial heating and cooling products (including VRV)
- ✓ Goal is to reflect the seasonal efficiency throughout the year, rather than the nominal efficiency that only occurs at peak load
- ✓ Sets minimum efficiency for performance targets on the actual year-round performance (cooling:  $\eta_{r,sc} = 133\%$ ; heating:  $\eta_{r,sh} = 181\%$ )

## How is the efficiency expressed?

- ✓ The seasonal efficiency of a system is calculated according to EN14825
- ✓ Expressed in "eta" values and % for cooling and heating operation:  $\eta_{r,sc}$  and  $\eta_{r,sh}$
- ✓ Allows direct comparison of fossil fuel products with electrically-drive products

## How to compare efficiencies?

- ✓ All efficiency data can be found on the free access website which each manufacturer has to make available
- ✓ **EN14825 does not specify the indoor unit type and size, so please carefully check which unit is mentioned on the product fiche**
- ✓ Daikin has chosen to test and list the most sold units to truly reflect the real life efficiency of the system, rather than selecting the largest units to achieve the highest possible theoretical efficiency

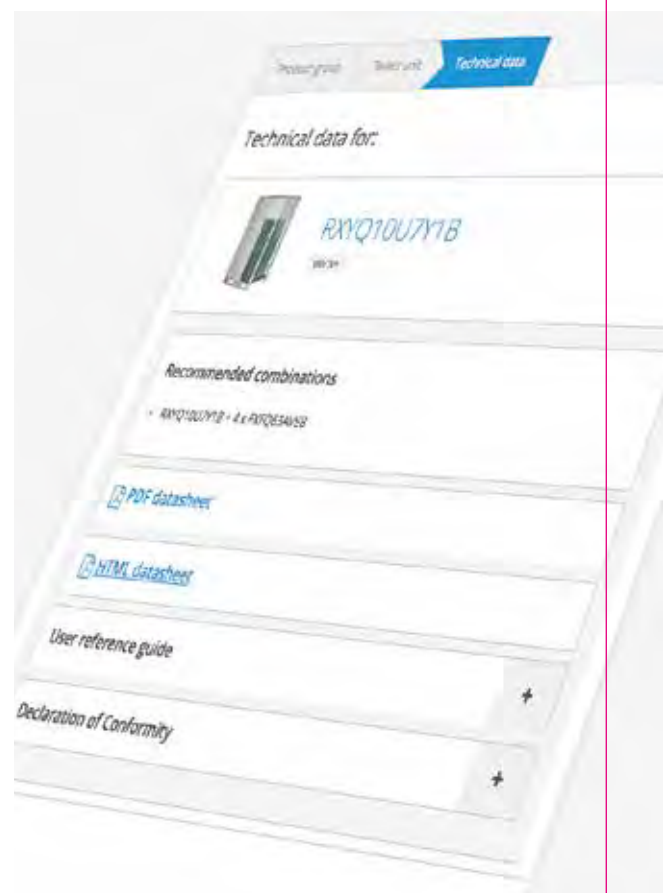

Visit our free access website  
<https://www.daikin.eu/seasonal-efficiency>

# User-friendly wired remote controller with premium design



White



Silver



Black



reddot award 2018  
winner



Advanced user settings



Field settings

## BRC1H519W/S/K(7)

- ✓ Sleek and elegant design
- ✓ Intuitive touch button control
- ✓ 3 color versions
- ✓ Advanced settings and monitoring can be easily done via your smartphone
- ✓ Flat back for easy wall installation
- ✓ Compact to fit standard size socket boxes

Find out more at  
page 164

## Modular L Smart:

Premium efficiency heat recovery fresh air unit

### Highlights

- ✓ Smart series connect plug&play in the Sky Air or VRV control network
- ✓ Directly available from stock
- ✓ Wide air flow coverage from 150m<sup>3</sup>/h to 3,450m<sup>3</sup>/h
- ✓ Solution for ducted installation (maximum ESP available: 600 Pa)
- ✓ High efficiency counter flow aluminium heat exchanger (up to 93%)
- ✓ Up to F7 (ePM1 50%) + F9 (ePM1 80%) filtration level

find out more at page 148

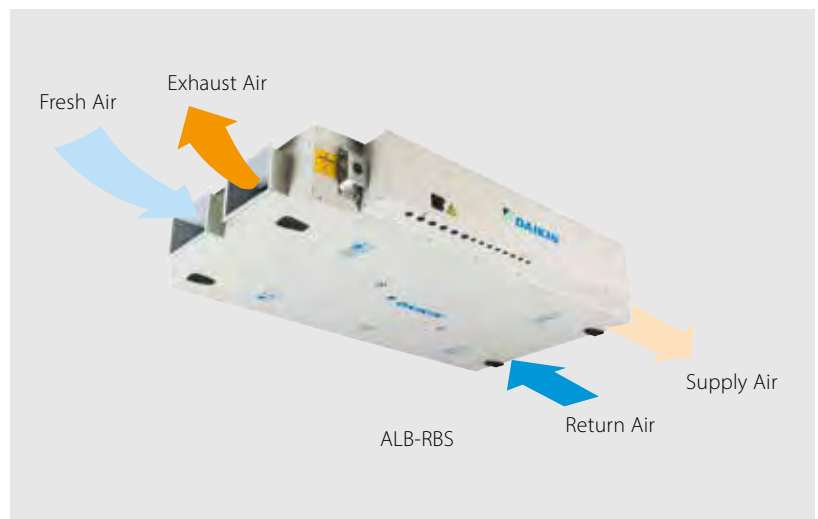

# BIM: Building Information Modelling

## What is BIM?

BIM is an intelligent model-based process that provides insight to help you plan, design, construct and manage buildings and infrastructure

## Collaboration and clash control

BIM uses a 3D model to provide the right information, to the right people, at the right time. This process improves efficiency throughout the design and building phases and increases savings by discovering clashes during the design phase, rather than later on during the building phase.

Find out more at [www.daikin.eu/BIM](http://www.daikin.eu/BIM)

## Daikin and BIM – putting you ahead of competition

Daikin is amongst the first manufactureres to provide a full library of BIM objects for it's VRV products.

- ✔ Installers get an edge over competition where customers demand for BIM to be used
- ✔ Consultants have direct access to the base data through the objects, to design the system and see how our solutions can fit your project
- ✔ Customers have easy access to latest relevant information needed to maintain and manage the installation.



# Green building solutions

**BREEAM**<sup>®</sup>

## Today's challenges

- ✔ In the near future the majority of new building projects in Europe are expected to be green
- ✔ 93% percent of developers & investors consider green certification important

Visit the minisite <http://www.daikineurope.com/minisite/sustainability/index.jsp>

## Daikin: the best partner for your green project

- ✔ We have a team of accredited professionals (AP's) at your service that support you and your customer throughout the project
- ✔ Daikin offers solutions that maximise your BREEAM, LEED and WELL scores with heat recovery, Variable Refrigerant Temperature and i-Net.
- ✔ Daikin has successfully participated in many green and sustainable projects across Europe



## Case: Velocity, UK

- ✔ Energy performance certificate B
- ✔ VRV heat recovery ensures an energy cost of less than 9 euro/m<sup>3</sup> compared to a typical cost of 29 euro/m<sup>3</sup>



# Which VRV

system offers me the best solution?

## Heat recovery or heat pump?

### VRV Heat recovery

Additional credits for green building certificate

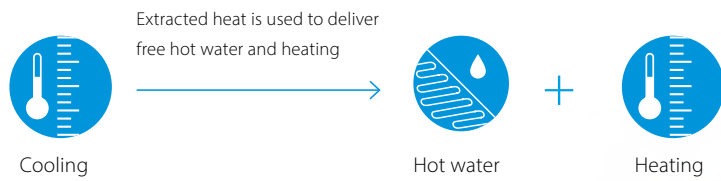

- > Simultaneous heating **AND** cooling from one system
- > "Free" heating and hot water production by transferring heat from areas requiring cooling
- > Maximum individual comfort in all areas
- > Technical cooling down to -20°C
- > Running costs of VRV IV heat recovery system can be 30 to 40% lower compared to water fan coil system\*

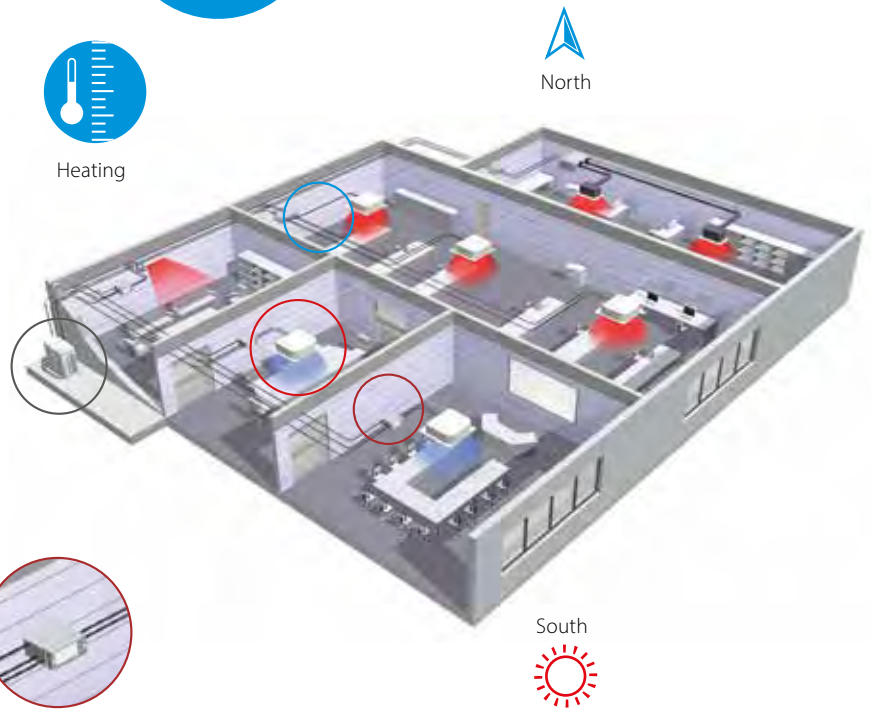

#### Components:

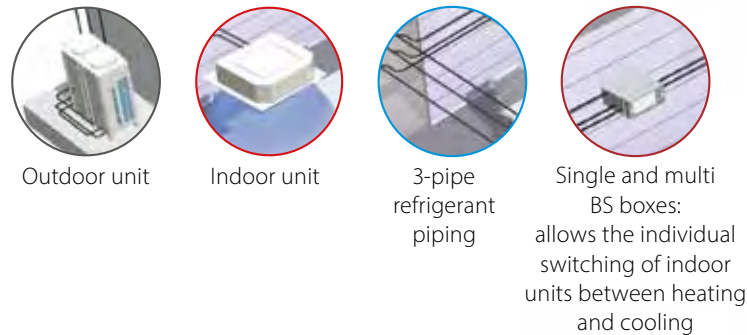

### VRV Heat pump

- > For either heating **OR** cooling operation from one system

#### Components:

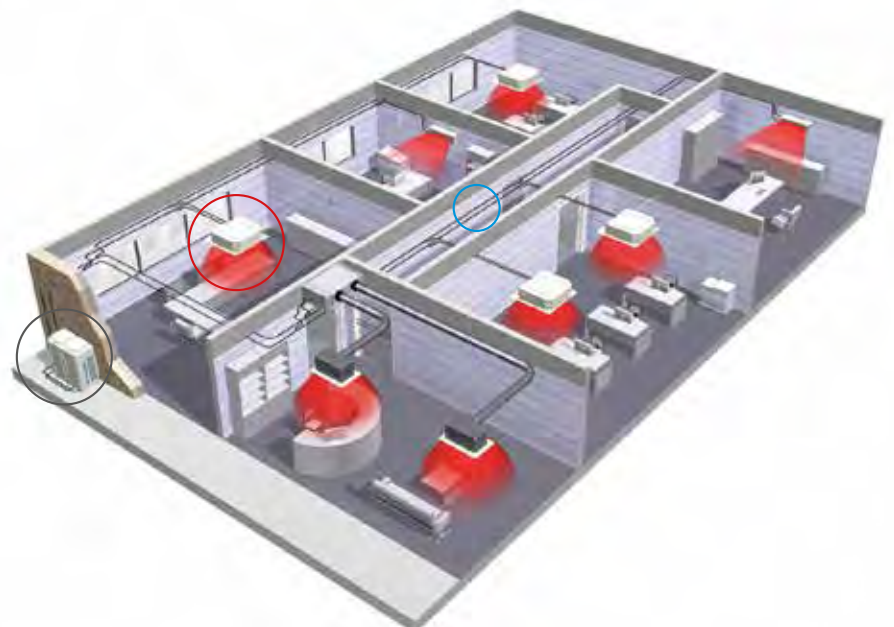
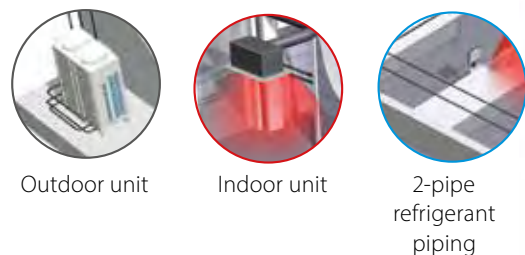

\* According to the Franklin + Andrews construction economics

# Air cooled or water cooled?

## Air Cooled

- > Fast and easy to install; no need for additional components
- > Low maintenance costs
- > Operation range from -25°C~52°C
- > Can be installed both outdoors and indoors
- > Up to 54HP capacity for one system

**Components:**



Outdoor unit



Indoor unit

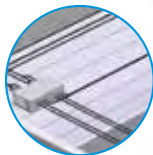

Refrigerant piping



## Water Cooled

- > Suitable for high rise and large buildings because of the nearly unlimited possibilities of water piping
- > Not affected by outdoor temperature/climate conditions
- > Reduce CO<sub>2</sub> emissions thanks to the use of geothermal energy as a renewable energy source
- > Allows heat recovery in the entire building thanks to the storage of energy in the water circuit
- > Lower refrigerant levels thanks to the limited distance between outdoor and indoor units

**Additional credits for green building certificate**

**Components:**



Outdoor unit



Indoor unit

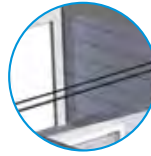

Refrigerant piping



(Geothermal) water loop



# Which applications?



Typically, many buildings today rely on several separate systems for heating, cooling, air curtain heating and hot water. As a result energy is wasted. To provide a much more efficient alternative, VRV technology has been developed into a total solution managing up to 70% of a buildings energy consumption giving large potential to cost saving.

- › **Heating and cooling** for year round comfort
- › **Hot water** for efficient production of hot water
- › **Underfloor heating /cooling** for efficient space heating/cooling
- › **Ventilation** for high quality environments
- › **Air curtains** for optimum air separation
- › **Controls** for maximum operating efficiency
- › **Cooling** for server rooms, telecom shelters, ... via VRV heat recovery or Sky Air units
- › **Refrigeration** via our VRV based refrigeration units

## Combine up to 70% of your building's energy consumption

Average hotel energy consumption

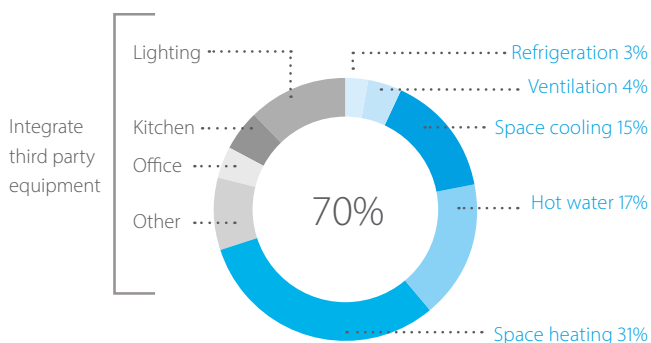

Average office energy consumption

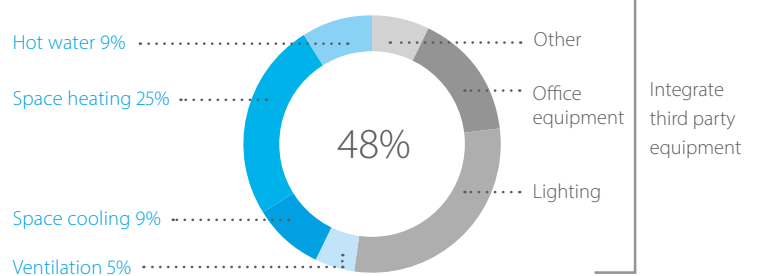

# One system, multiple applications for hotels, offices, retail, home ...

## Heating and cooling



- › Combine VRV indoor units with other stylish indoor units in one system
- › New round flow cassette sets the standard for efficiency and comfort
- › Extensive range of models and capacities for optimal selection

## Intelligent control systems



- › Mini BMS which connects Daikin and third-party equipment
- › Integrate intelligent control solutions with energy management tools to reduce running costs

## Low-temperature hot water



- › Highly efficient space heating through:
  - Underfloor heating
  - Low temperature radiators
  - AHU water heat exchangers
- › Hot water from 25 °C to 45 °C
- › Cold water from +5°C to +20°C

## Biddle air curtain

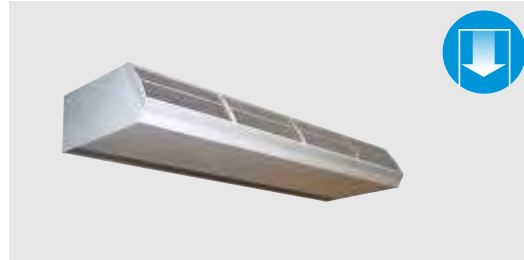

- › Payback time less than 1.5 years compared to electrical air curtain
- › A highly efficient solution for doorway climate separation

## High temperature hot water



- › Efficient hot water production for:
  - Showers
  - Sinks
  - Tapwater for cleaning
- › Hot water from 25 °C to 80 °C
- › Connectable to VRV heat recovery and Water - cooled VRV

## Fresh air



- › Widest range in DX ventilation – from small heat recovery ventilation to large scale air handling units
- › Provides a fresh, healthy and comfortable environment



## VRV for offices and banks

Efficiency in the workplace



Efficient building and facilities management are key to minimising operational costs

### Our solutions for offices:

- › Significantly reduced costs for hot water and heating by re-using heat recovered from areas requiring cooling
- › Unique cassette integrating fully flat into architectural ceilings
- › Intelligent sensors
  - maximise efficiency by raising the indoor set point or switching off the unit if there is nobody in the room
  - maximise comfort by directing the air flow away from people to avoid cold draughts
- › A complete Daikin mini Building Energy Management System (BEMS), with the Intelligent Touch Manager
- › Plug & play connection to air handling units for a healthier office atmosphere
- › Hot water production for sanitary use (e.g. kitchens) and space heating (e.g. underfloor loops)
- › Truly reliable technical cooling down to -20°C, including duty/standby function



Check on  
**YouTube**

[www.youtube.com/DaikinEurope](http://www.youtube.com/DaikinEurope)

## VRV for hotels

Hospitality with economy



A hotel's reputation depends on how welcome and comfortable guests feel during their stay. Yet at the same time, hotel owners must maintain complete control of their operating costs and energy consumption.

### Our solutions for hotels:

- › Low cost heating and hot water by recovering heat from areas requiring cooling
- › The perfect personal environment for guests by simultaneously heating spaces while cooling others
- › Flexible installation: the outdoor unit can be installed outdoors to maximise hospitality space or indoors to minimise external space or noise in city centres
- › Concealed ceiling units developed for small, well-insulated rooms such as hotel bedrooms, offering very low sound levels ensuring a good night's rest
- › Smart energy management via Intelligent Touch Manager puts the hotel owner in full control of energy costs
- › Intelligent and user-friendly hotel room controllers change the set point automatically when a guest leaves the room or opens the window
- › Easy integration in hotel booking software
- › Hot water production for bathrooms, underfloor heating and radiators up to 80°C

Check on  
**YouTube**

[www.youtube.com/DaikinEurope](http://www.youtube.com/DaikinEurope)

### Hotel



### Bank / Retail







## VRV for retail

Reducing retail costs



Retailers are under pressure to reduce both store development costs and running costs. That is why affordable, energy-efficient solutions are vital for minimising lifetime costs, while ensuring compliance with the latest regulations.

### Our retail solutions:

- > Compact inverter heat pump technology
- > Flexible installation: the outdoor unit can be installed outdoors to maximise commercial space or indoors to minimise external space or noise in city centres
- > Unique round flow cassettes with autocleaning panel saving up to 50% of energy use compared to standard cassette units
- > Intuitive touch screen intelligent Tablet Controller allowing multi site control via the Daikin Cloud Service
- > Easy to use remote control with lock-key function to avoid improper use
- > Individual control of each indoor unit or shop zone
- > Savings on running cost via pre/post trade modes, limiting energy use by lights, air conditioning, ...
- > The most efficient open-door solution with Biddle air curtains

## VRV for residential use

There is no place like home



A cost effective, low energy consumption heat pump system for home owners, offering maximum comfort

### Our residential solutions:

- > Lower CO<sub>2</sub> emissions compared to traditional heating systems
- > Compact outdoor unit design with a low sound level
- > Whisper-quiet indoor units down to 19dBA
- > Daikin Emura, iconic design wall mounted unit
- > Unique Nexura floor standing unit offering the feel of a radiator with the efficiency of a heat pump
- > Units to be concealed in the wall or ceiling to make them completely unnoticed
- > User-friendly, intuitive touch control, controlling your entire shop including lights, sensors, ...
- > Manage and control multiple shops from a central location via the Daikin Cloud Service
- > Up to 9 indoor units that can be connected to one outdoor unit

Want to know more about our commercial solutions?

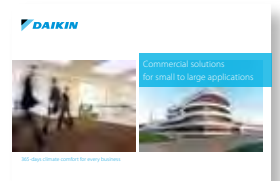

Check on  
**YouTube**

[www.youtube.com/DaikinEurope](http://www.youtube.com/DaikinEurope)

Residential





## VRV IV<sup>+</sup> standards & technologies

Our new VRV IV systems set pioneering standards in all-round climate comfort performance. Total design simplicity, offering rapid installation, full flexibility as well as absolute efficiency and comfort. Find out about all these revolutionary changes at

[www.daikineurope.com/vrviv](http://www.daikineurope.com/vrviv)

# VRV IV =

## 3 revolutionary standards

- › Variable Refrigerant Temperature
- › Continuous comfort during defrost
- › VRV configurator

## + unique VRV IV core technologies

- › Newly developed inverter compressor
- › Refrigerant-cooled PCB
- › 4-side heat exchanger
- › Predictive control
- › Outer rotor DC fan motor

# Unique variable refrigerant temperature

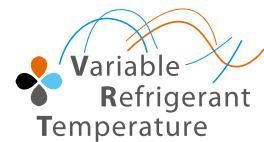

## The biggest leap since the inverter compressor

Thanks to its revolutionary variable refrigerant temperature technology (VRT), VRV IV+ continuously adjusts both the inverter compressor speed and the refrigerant temperature in cooling AND heating, providing the necessary capacity to meet the building load with the highest efficiency at all times!

- › **Seasonal efficiency increased by 28%**
- › **The first weather accommodating control on the market**
- › **Customer comfort is assured thanks to higher outdoor temperatures (preventing cold draughts)**

## How does it work?

### VRF standard

Capacity is controlled only with the variation of the inverter compressor

### Daikin VRV IV+

Variable Refrigerant Temperature control for energy saving in partial load condition.

The capacity is controlled by the inverter compressor and variation of the evaporating (Te) and condensing (Tc) temperature of the refrigerant in order to achieve the highest seasonal efficiency.

UNIQUE

UNIQUE

Evaporating temperature can vary between 3 and 16° which is the widest on the market.



**Calculate the benefit of variable refrigerant temperature for your project in our seasonal solutions calculator:**

<http://extranet.daikineurope.com/en/software/downloads/solutions-seasonal-simulator/default.jsp>

The colder it gets the lower the cooling need of the building

The lower the capacity need, the higher the refrigerant temperature can be

The higher the refrigerant temperature, the higher the efficiency

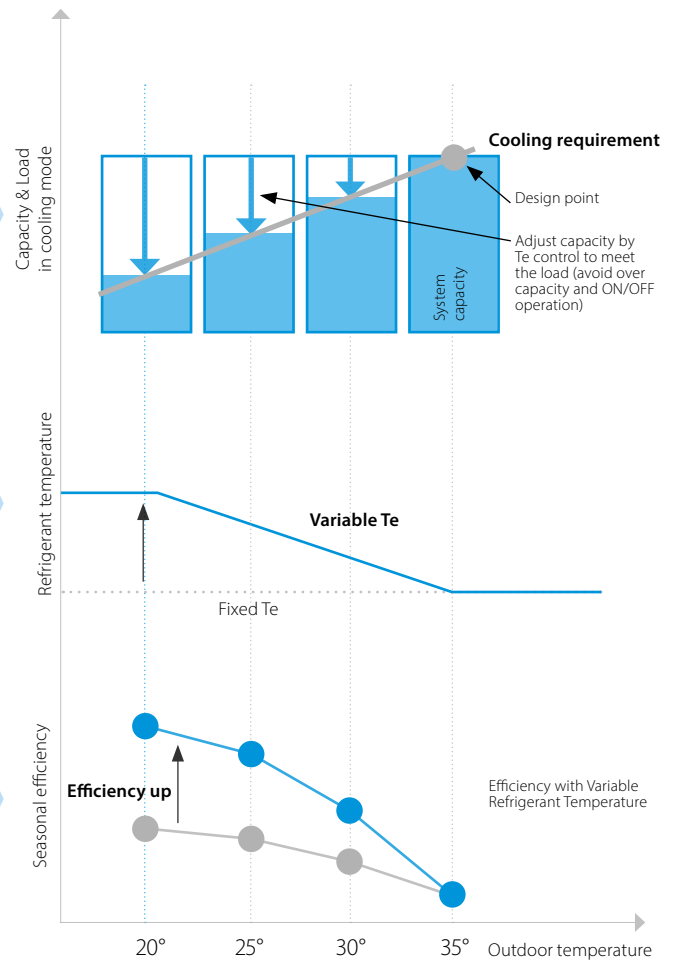

## Success story

### Real test: up to 46% less energy consumed

A field trial was carried out in a shop of a fashion chain in Germany and showed that the innovative Daikin VRV IV delivers dramatically better energy efficiency compared with previous models.

The trial results showed that the new VRV IV system consumed up to 60% less energy than the VRV III system, particularly during cooling. Overall energy savings during heating averaged 20%.

### How effective is the VRV IV+ heat pump technology?

The trial demonstrated that by using air, an infinitely renewable and free energy source, the VRV IV+ system provides a complete and environmentally sustainable solution for heating, cooling and ventilation in commercial applications. The trial also showed that only by monitoring climate control systems carefully and intelligently businesses can identify and control energy waste. **Contact Daikin for more information about monitoring services.**

## 8 Different modes to maximise efficiency and comfort



Check on  
**YouTube**

<https://www.youtube.com/DaikinEurope>

For maximum energy efficiency and customer satisfaction, the outdoor unit needs to adapt the evaporating/condensing temperature at the optimum point for the application.

## How to set the different modes?



Set up the main operation mode of the system	Define how the system reacts to changing loads	
<p><b>Step 1</b></p> <p><b>Automatic*</b> Evaporating AND condensing temperature automatically selected according to ambient temperature</p> <p>Quick reaction speed      Top efficiency</p> <p>The perfect balance: Achieves top efficiency throughout the year, reacts quickly on the hottest days</p>	<p><b>Step 2</b></p> <p>Powerful</p> <p>Quick</p> <p>Mild *</p>	<p>Where a quick increase of load is expected such as conference rooms. Quick reaction speed to changing load has priority, with temporarily colder outblow as a result.</p> <p>Same as above but slower response than the powerful mode.</p> <p>This mode would be suitable for most office applications and it is the factory set mode. The perfect balance: Slower reaction speed with top efficiency</p>
<p><b>High sensible</b> Target Te can be selected between 7°C to 11°C</p> <p>Quick reaction speed      Top efficiency</p> <p>Year round top efficiency</p>	<p>Powerful</p> <p>Quick</p> <p>Mild</p> <p>Eco</p>	<p>Gives customer choice for fixing coil temperature which avoids cold draughts. A quick reaction speed to changing load has priority, with temporarily colder outblow as a result.</p> <p>Same as above but slower response.</p> <p>The air off temperature remains fairly constant. Suitable for low ceiling rooms.</p> <p>Coil temperature would not change due to fluctuating load. Suitable for computer or low ceiling rooms.</p>
<p><b>Basic</b> Current VRF standard</p>	<p>No submodes</p>	<p>This is how most other VRF systems work and can be used for all general type of applications.</p>

\* Factory setting

	VRV III 20HP (2 modules)	VRV IV 18HP (1 module)
<b>Period</b>	March 2012 - February 2013	March 2013 - February 2014
<b>Avg (kWh/Month)</b>	2.797	1.502
<b>Total (kWh)</b>	33.562	18.023
<b>Total (€)</b>	6.041	3.244
<b>Yearly (operation cost/m<sup>2</sup> (€/m<sup>2</sup>))</b>	<b>9,9</b>	<b>5,3</b>
<b>46% savings = € 2.797</b>		

## Measured data

### Fashion store Unterhaching (Germany)

- › Floor space: 607m<sup>2</sup>
- › Energy cost: 0,18 €/kWh
- › System taken into account for consumption:
  - VRV IV heat pump with continuous heating
  - Round flow cassettes (without auto cleaning panel)
  - VAM for ventilation (2x VAM2000)
  - Biddle Air curtain.

# Real continuous heating

## during defrost mode

**VRV IV+ continues to provide heating even when in defrost mode, providing an answer to any perceived disadvantages of specifying a heat pump as a monovalent heating system.**

- › **Continuous indoor comfort ensured by the heat accumulating element and alternate defrost**
- › **An innovative alternative to traditional heating systems**



Check on  
**YouTube**

<https://www.youtube.com/DaikinEurope>

Heat pumps are known for their high energy efficiency in heating, but frost is accumulated on their heat exchanger during heating operation and this must be melted periodically using a defrost function that reverses the refrigeration cycle. This causes a temporary temperature drop and reduced comfort levels inside the building.

Defrosting can take over 10 minutes (depending on the size of the system) and occurs mostly between -7 and +7°C when humidity levels in the air are high. Humidity freezes on the coil, resulting firstly in poor performance and eventually low comfort levels. The VRV IV+ has changed the heating paradigm by providing heat even during defrost operation thus diminishing the temperature drop indoors and providing comfort at all times.

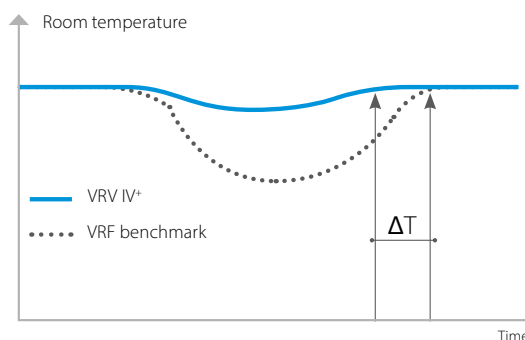

## How does it work?

### UNIQUE Heat accumulating element

For the VRV IV+ heat pump single unit systems a unique heat-accumulating element is used. This element, based upon phase change material, provides the energy to defrost the outdoor unit.

The outdoor unit coil is defrosted ...

... with the energy stored in the heat accumulating element ...

... so a comfortable temperature is maintained indoors.

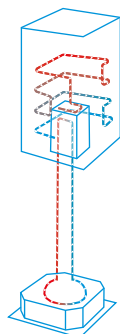

### Alternate defrost

On all our multi unit systems only 1 outdoor coil is defrosted at a time, ensuring continuous comfort during the whole process.

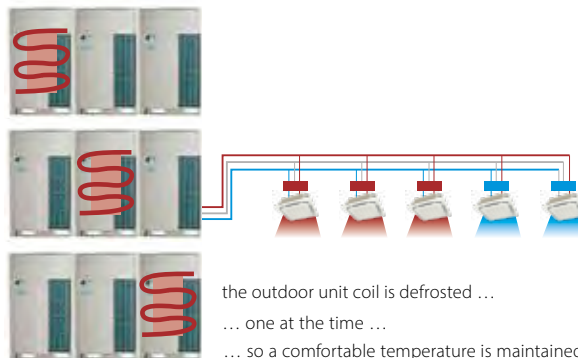

### Available on:

Heat pump
RYYQ8-20U

Water cooled VRV has no defrost cycles

### Available on:

Heat pump	Heat recovery	Replacement VRV
RYYQ16-54U	REYQ10-54U	RXYQQ16-42U
		RQCEQ280-848P3

# VRV Configurator

## Software for simplified commissioning, configuration and customisation

- › Graphical interface
- › Manage systems over multiple sites in exactly the same way
- › Retrieve initial settings



Check on  
**YouTube**

<https://www.youtube.com/DaikinEurope>

## Configurator software for simplified commissioning

The VRV configurator is an advanced software solution that allows for easy system configuration and commissioning:

- › less time is required on the roof configuring the outdoor unit
- › multiple systems at different sites can be managed in exactly the same way, thus offering simplified commissioning for key accounts
- › initial settings on the outdoor unit can be easily retrieved.

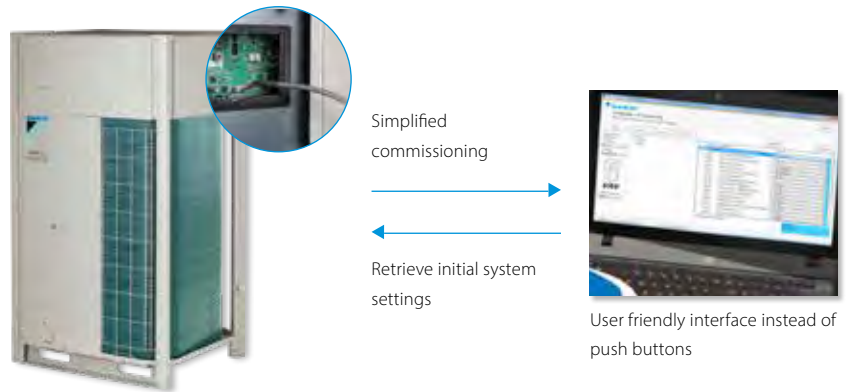

# 7-segment display

## for quick and accurate error diagnosis

Outdoor unit display for quick on-site settings and easy read out of errors together with the indication of service parameters for checking basic functions.

- › easy-to-read error report
- › clear menu indicating quick and easy on-site settings
- › indication of basic service parameters to quickly check basic functions: high pressure, low pressure, frequency and operation time history of compressors, temperature of discharge/suction pipe.
- › No need to unmount the big front panel of the unit thanks to the service access



3 digit 7-segment display

### Available on:

Heat recovery	Heat pump	Replacement VRV
REYQ-U	RYYQ-U	RXYQQ-U
	RXYQ-U	
	RXYSCQ-TV1 (only configurator, no 7 segment display)	
	RXYSQ-T8V/T8Y/TY1 (only configurator, no 7 segment display)	
	SB.RKXYQ-T(8) (only configurator, no 7 segment display)	

# Unique VRV IV core technologies

37 patents



## NEW Scroll compressor

### Back pressure control **UNIQUE**

- › Pressure port increases pressure below the scroll in low load operation, preventing refrigerant leak from the high to low pressure side
- › Increased partial load efficiency



Check on



<https://www.youtube.com/DaikinEurope>

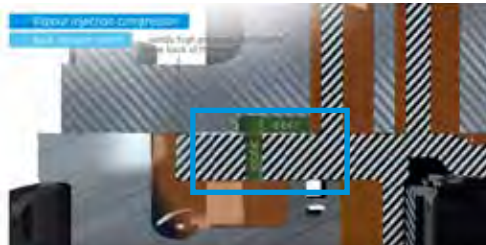

The back pressure control port sends high pressure refrigerant to the back of the scroll, preventing refrigerant leakage



Refrigerant leak at low load with conventional compressor

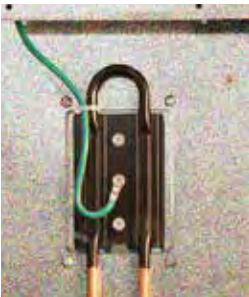

## Refrigerant-cooled PCB

- › Reliable cooling because it is not influenced by ambient air temperature
- › Smaller switchbox for smoother air flow through the heat exchanger increasing heat exchange efficiency with 5%

6 patents

UNIQUE

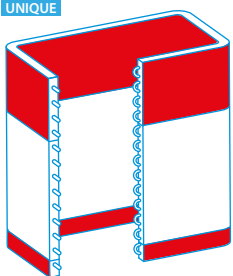

## 4-sided, 3-row heat exchanger

- › Heat exchange surface up to 50% larger
- › (up to 235m<sup>2</sup>), leading to 30% more efficiency

10 patents





## UNIQUE

# Predictive Control Function (PCF)

- > Reaching targets faster
- > Reaching targets without overshooting, so there is no waste, resulting in improved efficiency

The large number of Daikin systems already in operation and which are monitored by our i-Net software put us in the unique position of being able to analyse this data and develop the predictive control function.

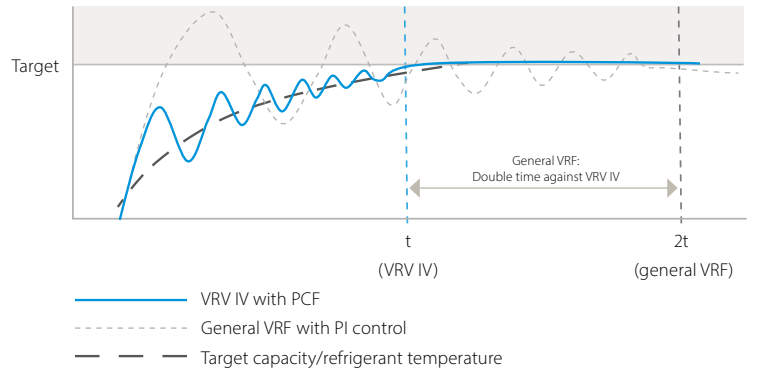

### VRV IV: PCF

Compressor works with predictive data for the control

- > result: quick convergence to the target temperature and reduction of waste operation of the compressor

**Half time against general VRF**

### General VRF: Pi control

Compressor works with feedback only for the control

- > result: waste operation and longer time before reaching target set point

## DC fan motor

## UNIQUE

### Outer rotor DC motor for higher efficiency

- > Larger rotor diameter results in greater force for the same magnetic field, leading to better efficiency
- > Better control, resulting in more fan steps to match the actual capacity

### Sine wave DC inverter

Optimizing the sine wave curve results in smoother motor rotation and improved motor efficiency.

### DC fan motor

The use of a DC fan motor offers substantial improvements in operating efficiency compared to conventional AC motors, especially during low speed rotation.

Conventional motor with inner rotor

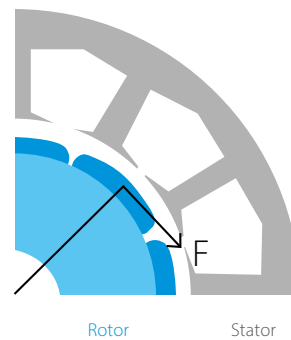

Daikin outer rotor

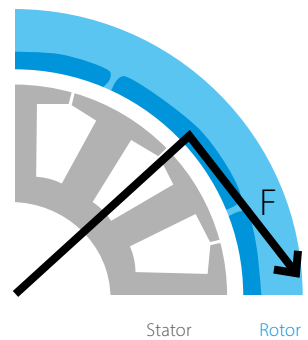

## E-Pass heat exchanger

Optimising the heat exchanger's path layout prevents heat being transferred from the overheated gas section to the sub-cooled liquid section which is a more efficient way to use the heat exchanger.

Standard heat exchanger

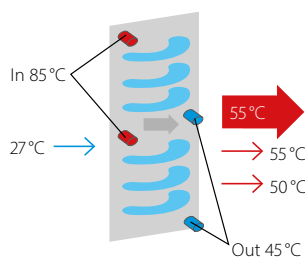

e-Pass heat exchanger

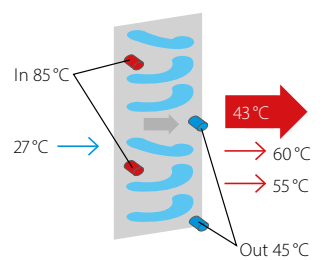

## I-demand function

Limit maximum power consumption. The newly introduced current sensor minimizes the difference between the actual power consumption and the predefined power consumption.

Power consumption

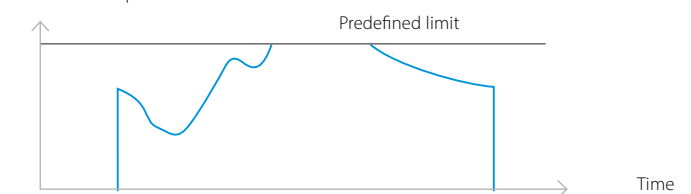



## The VRV benefits

See how you can benefit from Daikin's highly flexible and efficiency product range

# VRV

## Latest technology, highest efficiency

### VRV, a total commercial solution

Drastically reducing your running costs Top reliability Up to 6 times greater resistance against corrosion	28
Comfort guaranteed at all times	30
Great design flexibility	32
Fast installation and commissioning Easy servicing	34

- Drastically reducing running costs
- Top reliability
- Up to 6 times greater resistance against corrosion

## Precise zone control

VRV systems have low running costs because it permits each zone to be controlled individually. That is, only those rooms that require air conditioning will be heated or cooled, while the system can be shut down completely in rooms where no air conditioning is required.

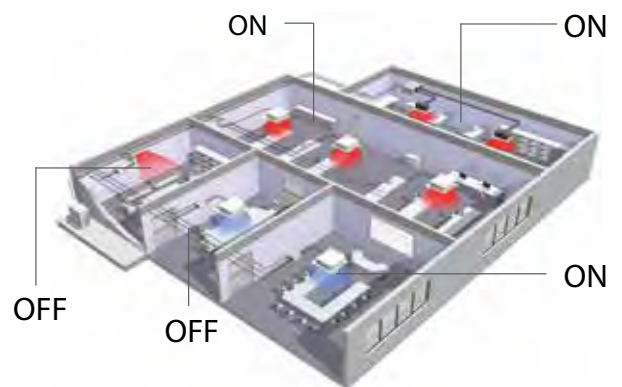

## Anti Corrosion Treatment

Special anti corrosion treatment of the heat exchanger provides 5 to 6 times greater resistance against acid rain and salt corrosion.

The provision of rust proof steel sheet on the underside of the unit gives additional protection.

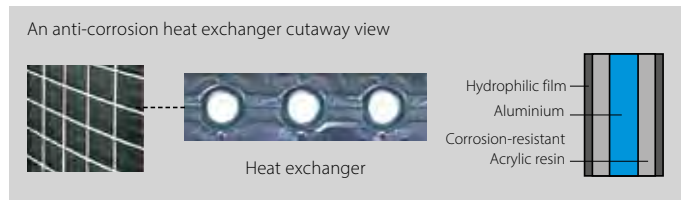

### Performed tests:

- › VDA Wechseltest
- › Contents of 1 cycle (7 days):
- › 24 hours salt spray test SS DIN 50021
- › 96 hours humidity cycle test KFW DIN 50017
- › 48 hours room temperature & room humidity testing period: 5 cycles

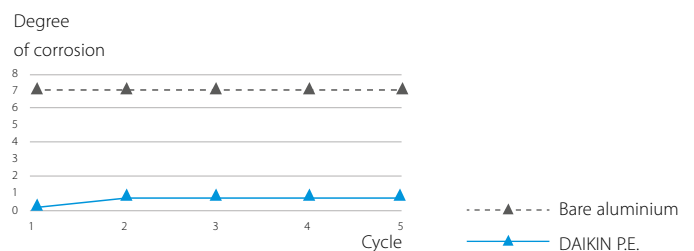

### Kesternich test (SO2)

- › contents of 1 cycle (48 hours) according to DIN50018 (0.21)
- › testing period : 40 cycles

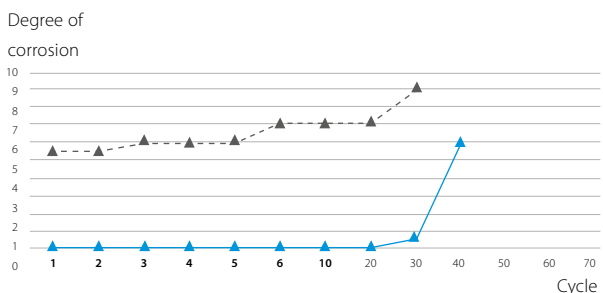

## All inverter compressors

All inverter control compressors allow to control the refrigerant volume almost stepless. In this way the capacity perfectly matches the different loads in every room avoiding unnecessary energy use.

Additionally all inverter compressors also allow precise refrigerant temperature control, automatically adapting your VRV to your building and climate requirements, reducing running costs with 28%.

Even more, having no ON/OFF compressors, means total absence of high starting currents, which are being more and more limited by the grid operators and power suppliers.

## Duty Cycling extends operation life

The cyclical start-up sequence of multiple outdoor units systems equalises compressor duty and extends operating life.

## Sequential Start

Up to 3 outdoor units can be connected to 1 power supply and can be turned on sequentially. This allows the number of breakers and their capacities to remain small and simplifies wiring (for models of 10HP or less).

## Top quality Only brazed connections

All flange and flare connections inside the unit have been replaced by brazing connections to ensure improved refrigerant containment. Also the connection of the outdoor in the main pipe is brazed.



Only one power supply

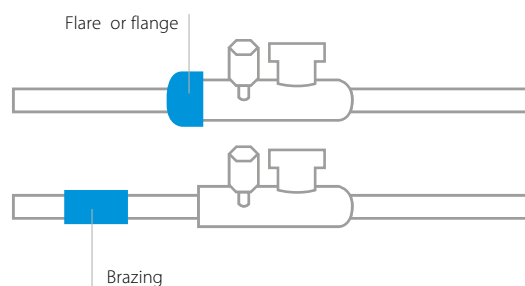

# • Comfort guaranteed at all times

## Smart Control brings comfort

### Stable room temperature

An electronic expansion valve, using PID (Proportional Integral Derivative) control, continuously adjusts the refrigerant volume in response to load variations of the indoor units. The VRV system thus maintains comfortable room temperatures at a virtually constant level, without the temperature variations typical of conventional ON/OFF control systems.

Note: The graph shows the data, measured in a test room assuming actual heating load. The thermostat can control stable room temperature at  $\pm 0.5^\circ\text{C}$  from set point.

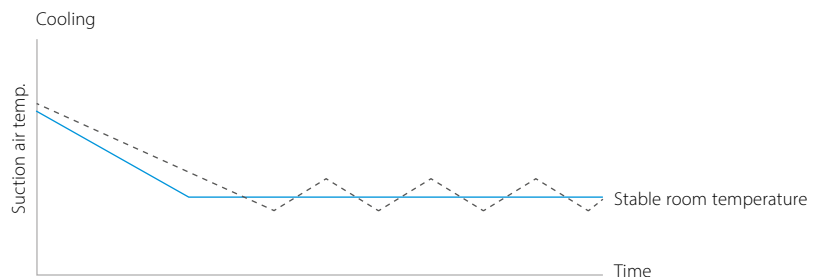

— VRV SERIES (DAIKIN indoor unit (PID controlled))  
 - - - ON/OFF controlled indoor unit (2.5HP)

### No more cold draught

Automatic or manual adjustment of refrigerant temperature leads to higher outblow temperatures which avoid the cold draught coming from the indoor unit.



Constant and high air discharge temperature

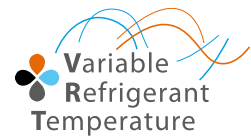

Available on all VRV IV units

## Continuous heating

### During defrost

- > Indoor comfort not effected via the unique heat accumulating element or alternate defrost
- > The best alternative to traditional heating systems

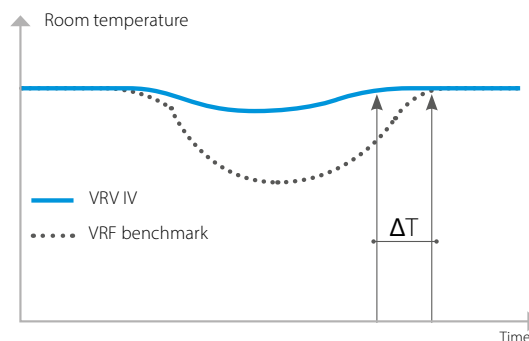

Available on REYQ-U, RYYQ-U, RXYQ-U and RXYQQ-U

## Back-up function

In the event of a compressor malfunction another compressor or outdoor unit will take over in order to maintain 8 hour interim capacity, allowing time for maintenance or repair while comfort remains guaranteed.



Single outdoor unit with multiple compressors



Multi outdoor unit system

## Prevent energy losses from over-ventilation with CO<sub>2</sub> sensor

Enough fresh air is needed to create an enjoyable environment, but ventilating constantly is leading to energy waste. Therefore an optional CO<sub>2</sub> sensor can be installed which switches off the ventilation system when there is enough fresh air in the room, thus saving energy.

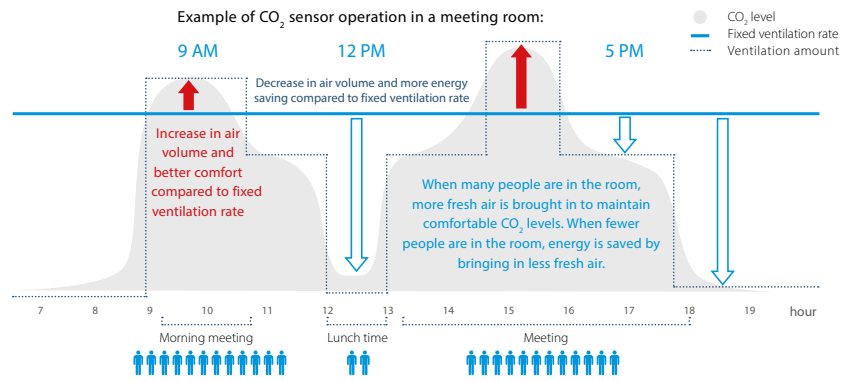

## Low indoor unit operation sound level

Daikin indoor units have very low sound operation levels, down to 19dB(A), making them ideal for sound sensitive areas as hotel bedrooms, etc...

db(A)	Perceived loudness	Sound
0	Threshold of hearing	-
20	Extremely soft	Rustling leaves
40	Very soft	Quiet room
60	Moderately loud	Normal conversation
80	Very loud	City traffic noise
100	Extremely loud	Symphonic orchestra
120	Threshold of feeling	Jet taking off

## Daikin indoor units:



19dB(A)

Connectable to VRV IV<sup>+</sup>, VRV IV C<sup>+</sup>series and VRV IV W<sup>+</sup>series

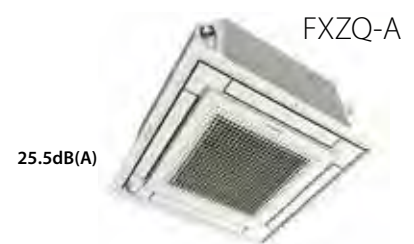

25.5dB(A)

Connectable to all VRV heat pumps

## Night quiet mode

For areas where there are stringent limitations to sound levels, the outdoor unit sound level can be automatically reduced to meet the requirement.

- Capacity\* %
- Load %
- Operation Sound dBA

To manually set the time for low noise operation you can use the external control adaptor DTA104A61/62/53.

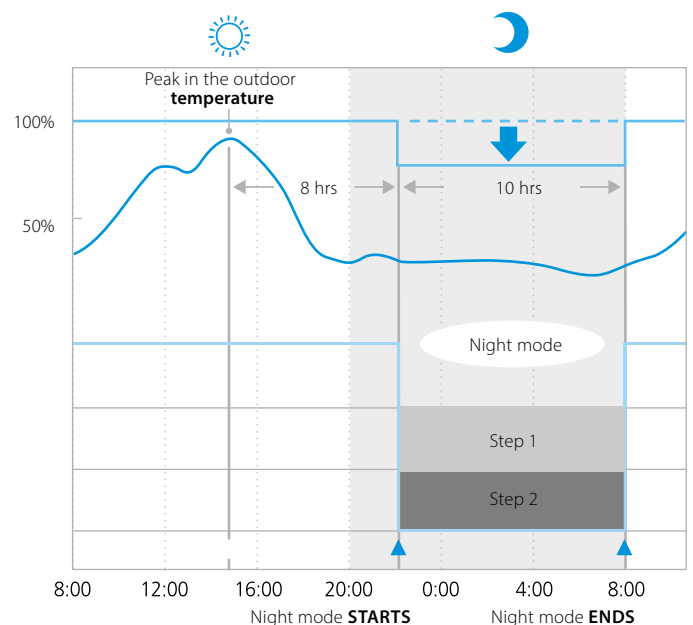

Example for VRV IV heat pump, factory setting.

# • Great design flexibility

## Wide operation range

### Air cooled

The VRV system can be installed practically anywhere. VRV air cooled outdoor units can cool between -20°C BD and +52°C DB outdoor ambient and can be used as monovalent heating system between -25°C WB and +15.5°C WB.

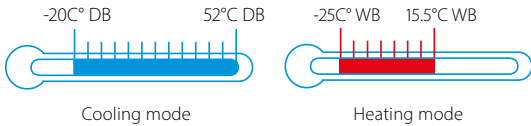

With the technical cooling function, the operation range in cooling of the heat recovery system is extended from -5°C to -20°C<sup>1</sup>, making it perfect for integrating server rooms.

### Water cooled

Standard water cooled outdoor units operation between 10°C & 45°C for both heating and cooling. In geothermal mode, the operation range is extended to -10°C\* during heating and 6°C during cooling. These units are not influenced by external conditions and function well in extreme climates.

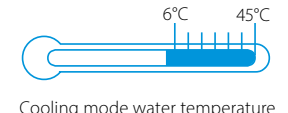
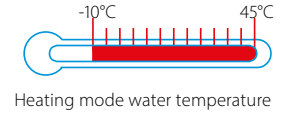

\* Ethylene glycol should be added to the water when the water inlet temperature is below 5°C

## Flexible piping design

The long piping lengths, high level differences and small refrigerant piping allows for a design with little limitations and leaving maximum space for lettable space.

<sup>1</sup> Contact your local dealer for more information and restrictions

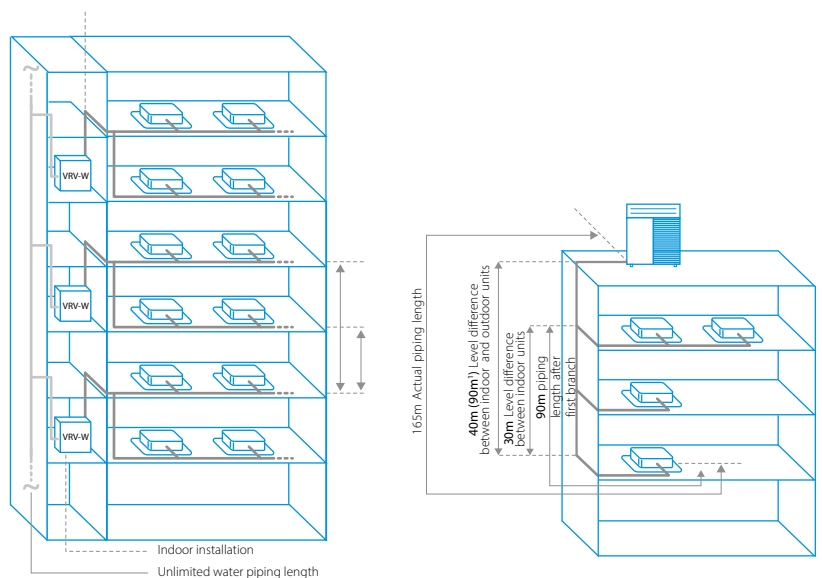

### VRV IV example

	Air cooled	Water cooled
Total piping length	1000m	500m
Longest length actual (Equivalent)	165m (190m)	165m (190m)
Longest length after first branch	90m <sup>1</sup>	40m (90m <sup>1</sup> )
Level difference between indoor and outdoor units	90m <sup>1</sup>	50m (40m <sup>2</sup> )
Level difference between indoor units	30m	30m

<sup>1</sup> Contact your local dealer or consult technical literature for more information and restrictions

<sup>2</sup> In case outdoor unit is located below indoor units

## Phased installation

Installation of the VRV system can be implemented floor by floor, so that sections of the building can be put into use very quickly, or enabling the air conditioning system to be commissioned and operated in stages, rather than on final completion of the project.

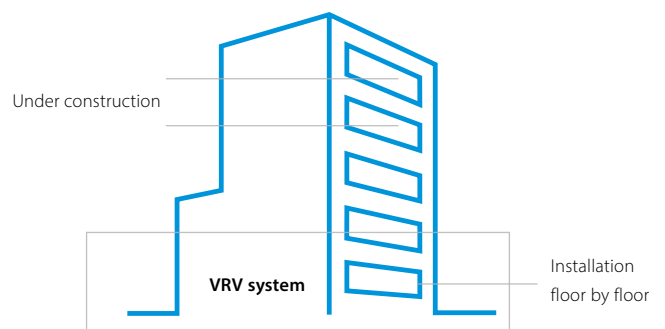



## Indoor installation

### Air cooled

#### Standard outdoor unit installed indoors

The VRV optimised fan blade shape increases output and reduces pressure loss. Together with the high ESP setting (up to 78.4 Pa), it makes VRV outdoor units ideal for indoor installation using ducts.

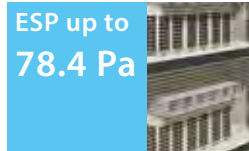

#### VRV IV i-series heat pump for indoor installation

The ultimate and unique solution from Daikin is to use the VRV IV i-series. This unit is optimised for indoor installation and is the most flexible solution, without the need for a large technical room to put the outdoor unit and it is complete invisible!

More details on page 62

### Water cooled

- › Seamless integration in the surrounding architecture as you cannot see the unit
- › Highly suited for sound sensitive areas as there is no external operation sound
- › Superior efficiency, even in the most extreme outside conditions, especially in geothermal operation



## Multiple tenants, one outdoor unit

The multi tenant function ensures that the entire VRV system does not shut down when the main power supply of an indoor is switched off. This means that the indoor unit's main power supply can be turned off when a part of the building is closed or is being serviced without affecting the rest of the building.

### 2 solutions according to the needs:

- › Service setting, without additional hardware: for service execution within 24 hours
- › PCB option: when tenants leave for a longer period (holiday) and the main power supply is shut down

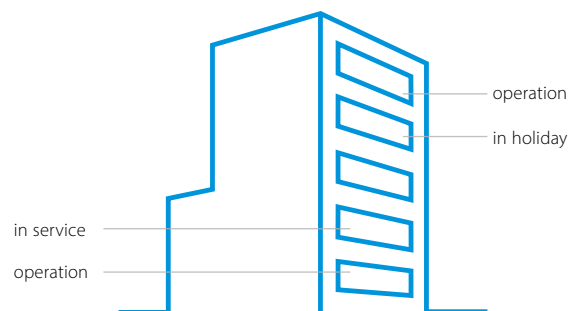

## No structural reinforcement necessary

Thanks to the vibration-free and sufficient light construction of the outdoor units, floors do not need to be reinforced, reducing the overall cost of the building when compared to a chiller.

max. 398kg for a 20HP unit



- Fast installation and commissioning
- Easy servicing

## Automatic charging & testing

### Efficient use of time

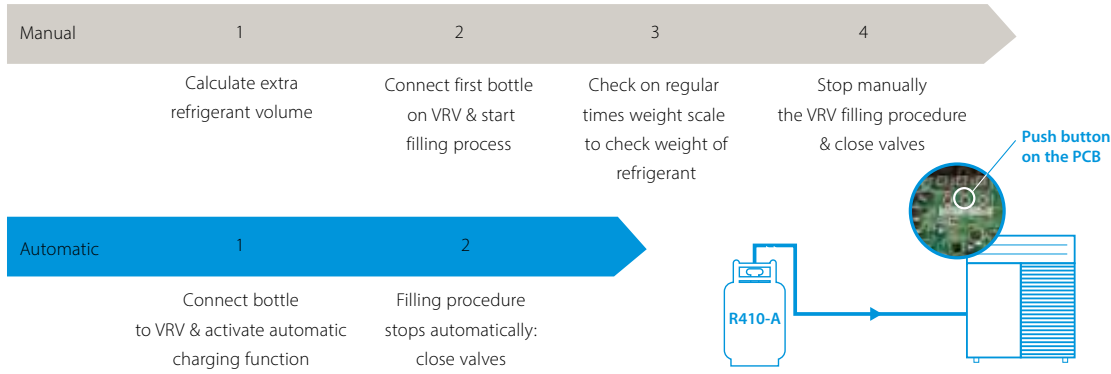

After charging, pushing the test operation button initiates a check on the wiring, shut off valves, sensors and refrigerant volume.

If the temperature drops below 20°C\* manual charging is necessary.

\* 10°C for heat pump for cold regions

\* Available on REYQ-U, RYYQ-U, RXYQ-U, RQYQ-P, RXYQQ-U, RQCEQ-P3

## Did you know ...

### Optimal charge = optimal efficiency

**Planned installation**  
64 m refrigerant piping

calculation:  
**2.2 kg** extra refrigerant required

↕ 0.5 kg

**Real installation**  
76 m refrigerant piping

**2.7 kg** extra refrigerant required in reality

10% undercharged

up to 25% capacity loss

33% more energy use

## Compliance to F-gas regulation

### Remote refrigerant containment check

Perform the refrigerant containment check remotely via intelligent Touch Manager.

When activating the refrigerant containment check, the unit switches into cooling mode and duplicates certain reference conditions based on memory data. The result indicates whether or not refrigerant leakage has occurred.

The refrigerant volume of the complete system is calculated for the following data:

- > Outdoor temperature
- > Reference system temperatures
- > Reference pressure temperatures
- > Refrigerant density
- > Types and number of indoor units



Remotely set the time and start the refrigerant containment check when it is most convenient for you.

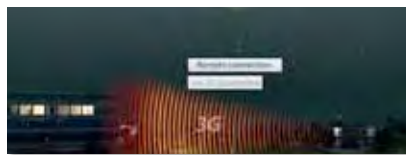

Connect to customer site via internet or 3G increasing customer satisfaction as there is no disruption to the air conditioning during business hours.



Check the report once the check has been done.

Available on REYQ-U, RYYQ-U, RXYQ-U

Next to remote checking, the function can also be activated on-site via a push button on the PCB.

## VRV configurator software

For simplified commissioning, configuration and customisation

**Available on REYQ-U, RYYQ-U, RXYQ-U, RXYSCQ-TV1, RXYSQ-TY8V/T8Y/TY1, SB.RKXYQ-T(8) and RXYQQ-U**

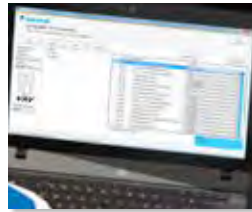

User friendly interface instead of push buttons



3 digit 7-segment display

## Compact design

The compact design of the outdoor units is sufficient to allow them to be taken up to the top of a building in a commercial elevator, overcoming site transportation problem, particularly when outdoor units need to be installed on each floor.

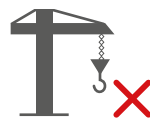

## Daikin unified REFNET piping

The unified Daikin REFNET piping system is designed for simple installation.

Compared to regular T-joints, where refrigerant distribution is far from optimal, the Daikin REFNET joints have specifically been designed to optimise refrigerant flow.

Daikin Europe N.V. advises only to use Daikin REFNET piping system.

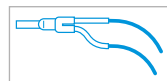

REFNET joint

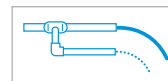

T-joint



REFNET joint



REFNET header

## Easy wiring - "Super Wiring" System

### Simplified wiring

Shared use of wiring between indoor units, outdoor units and centralised remote control

- > Easy retrofit of centralised remote control
- > Impossible to make incorrect connections thanks to non polarity wiring
- > Sheated wire can be used
- > Unique total wiring length up to 2,000 m

### Cross wiring check

The cross wiring check function warns operatives of connection errors in inter unit wiring and piping.

### Auto Address Setting Function

Allows wiring between indoor and outdoor units, as well as group control wiring of multiple indoor units, to be performed without the bothersome task of manually setting each address.

\* auto address setting function is not available for centralized operation





# VRV Outdoor Systems

For every application a solution











# Overview of functions



	VRV IV <sup>+</sup> Heat recovery	VRV IV <sup>+</sup> heat pump with continuous heating	VRV IV <sup>+</sup> heat pump without continuous heating	VRV IV S-series (compact)	VRV IV i-series	VRV IV C <sup>+</sup> series	Replacement VRV III Heat recovery	Replacement VRV IV <sup>+</sup> heat pump	VRV IV W <sup>+</sup> series
	REYQ-U	RYYQ-U	RXYQ-U	RXYSCQ-TV1 RXYSQ-T8V RXYSQ-T8Y RXYSQ-TY1	SB.RKXYQ-T (8)	RXYLQ-T	RQCEQ-P3	RQYQ-P RXYQQ-U	RWEYQ-T9
Page	42	50	50	56	64	73	79	79	84
Variable Refrigerant Temperature	●	●	●	●	●	●	✗	●	●
Continuous heating (heat accumulating element)	✗	●	✗	✗	✗	✗	✗	✗	-
Continuous heating (alternate defrost)	●	●	✗	✗	✗	✗	✗	✗	-
VRV configurator	●	●	●	●	●	●	✗	●	●
7 segment display	●	●	●	✗	✗	●	✗	●	●
Automatic refrigerant charge	●	●	●	✗	✗	●	●	●	✗
Refrigerant containment check	●	●	●	✗	✗	●	✗	✗	✗
Night quiet mode	●	●	●	●	●	●	●	●	-
Low noise function	●	●	●	●	●	●	●	●	-
Connectable to stylish indoor units (Daikin Emura, Nexura)	✗	●	●	● (1)	✗	●	✗	✗	●
Connectable to LT hydrobox for hot water	●	●	●	✗	✗	●	✗	✗	●
Connectable to HT hydrobox for hot water	●	✗	✗	✗	✗	✗	✗	✗	●
Full inverter compressors	●	●	●	●	●	●	●	●	●
Gas cooled PCB	●	●	●	● <small>not available on RXYSQ4,5,6,8TY1</small>	✗	●	✗	●	✗
4 side heat exchanger	●	●	●	✗	✗	●	✗	●	-
Reluctance brushless DC compressor	●	●	●	●	✗	●	●	●	●
Sine wave DC inverter	●	●	●	●	●	●	●	●	●
DC fan motor	●	●	●	●	●	●	●	●	-
E-pass heat exchanger	●	●	●	●	●	●	●	●	-
I demand function	●	●	●	●	●	●	●	●	✗
Manual demand function / power limitation	●	●	●	●	●	●	●	●	●

(1) Either connect VRV or stylish indoor units

# Products overview **VRV**

Model	Product name	4	5	6	8	10	12	13	14	16	18	20	22	24	26	28	30			
<b>Air cooled - heat recovery</b> <b>NEW</b> VRV IV heat recovery Best efficiency & comfort solution > Fully integrated solution with heat recovery for maximum efficiency > Covers all thermal needs of a building via a single point of contact: accurate temperature control, ventilation, hot water, air handling units and Biddle air curtains > "Free" heating and hot water through heat recovery > The perfect personal comfort for guests/tenants via simultaneous cooling and heating > Incorporates VRV IV standards & technologies such as Variable Refrigerant temperature and continuous heating > Allows technical cooling > Widest range of BS boxes on the market	REYQ-U <b>VRV IV<sup>+</sup></b> 				●	●	●		●	●	●	●								
	RYYQ-U <b>VRV IV<sup>+</sup></b> 				●	●	●		●	●	●	●								
	RXYQ-U <b>VRV IV<sup>+</sup></b> 				●	●	●		●	●	●	●								
<b>Air cooled - heat pump</b> VRV IV-S series Compact The most compact VRV > Compact and lightweight single fan design saves space and is easy to install > Covers all thermal needs of a building via a single point of contact: accurate temperature control, ventilation, air handling units and Biddle air curtains > Either connect VRV of stylish indoor units (Daikin Emura, Nexura) > Incorporates VRV IV standards & technologies such as Variable Refrigerant temperature	RXYSCQ-TV1 <b>VRV IV S-series Compact</b> 	●	●																	
	RXYST8V/ T8V/TY1 <b>VRV IV S-series</b> 	T8V	●	●	●															
	T8V/ TY1 <b>VRV IV S-series</b> 	T8V/ TY1	●	●	●	●	●	●												
<b>UNIQUE</b> VRV IV heat pump for indoor installation The invisible VRV > Unique VRV heat pump for indoor installation > Total flexibility for any shop location and building type as the outdoor unit is invisible and split up in 2 parts > Incorporates VRV IV standards & technologies such as Variable Refrigerant temperature > Covers all thermal needs of a building via a single point of contact: accurate temperature control, ventilation and Biddle air curtains	SB.RKXYQ-T(8) <b>VRV IV i-series</b> 		●	●																
<b>NEW</b> VRV IV heat pump, optimised for cold climates Where heating is priority without compromising on efficiency > Suitable for single source heating > Extended operation range down to -25°C in heating > Stable heating capacity without any capacity loss down to -15°C	RXYLQ-T <b>VRV IV C<sup>+</sup> series</b> 				●	●			●	●	●	●	●	●	●	●	●	●	●	
<b>Replacement</b> heat recovery Quick & quality replacement for R-22 and R-407C systems > Cost-effective and fast replacement through re-use of existing piping > Drastically improve your comfort, efficiency and reliability > No interruption of daily business while replacing your system > Replace Daikin and other manufacturers systems safely	RQCEQ-P3 <b>VRV III Q</b> 							●	●	●	●	●	●	●	●	●	●	●	●	
	<b>NEW</b> heat pump Quick & quality replacement for R-22 and R-407C systems > Cost-effective and fast replacement through re-use of existing piping > Drastically improve your comfort, efficiency and reliability > No interruption of daily business while replacing your system > Replace Daikin and other manufacturers systems safely > Incorporates VRV IV standards & technologies such as Variable Refrigerant temperature	RXYQQ-U <b>VRV IV Q<sup>+</sup> serie</b> 	●			●	●	●		●	●	●	●	●	●	●	●	●	●	●
<b>Water cooled</b> Water cooled VRV IV Ideal for high rise buildings, using water as heat source > Reduced CO2 emissions thanks to the use of geothermal energy as a renewable energy source > No need for an external heating or cooling source when used in geothermal mode > Compact & lightweight design can be stacked for maximum space saving > Incorporates VRV IV standards & technologies such as Variable Refrigerant temperature > Variable Water Flow control option increases flexibility and control > Mixed connection of HT hydroboxes and VRV indoor units > Either connect VRV of stylish indoor units (Daikin Emura, Nexura) > 2 analogue input signals allowing external control	RWEYQ-T9* <b>VRV IV W<sup>+</sup> series</b> 				●	●	●		●											

Ranges marked with "\*" are not Eurovent certified. Multi combinations are not in scope of the Eurovent certification programme

● Single unit  
● Multi combination

Capacity (HP)													Description / Combination	VRV indoor units	Residential indoor units	LT Hydrobox HXY-A	HT Hydrobox HXHD-A	HRV units VAM-, VKM-	AHU connection EKEXV + EKEQMCBA	AHU connection EKEXV + EKEQFCBA	Air curtains CYV-DK-	Remarks	
32	34	36	38	40	42	44	46	48	50	52	54												
													<b>VRV IV* Heat Recovery</b> REYQ-T	○	×	○	○	○	○	×	○	> Standard total system connection ratio limit: 50 ~ 130%	
													with only VRV indoor units	✓									
													with LT/HT Hydroboxes	✓		✓	✓	✓				> Max 32 indoor units, even on 16HP and larger systems > Total system connection ratio with HT hydroboxes up to 200% possible	
													HRV units VAM-, VKM-	✓		✓	✓	✓		✓		> Dedicated systems (with only ventilation units) not allowed – a mix with standard VRV indoor units is always necessary	
●	●	●	●	●	●	●	●	●	●	●	●	●	AHU connection EKEXV + EKEQMCBA	✓				✓	✓		✓		
													Biddle air curtain CYV-DK-	✓				✓	✓		✓	> Total system connection ratio with AHU is 50 ~ 110%	
													<b>VRV IV* Heat Pump</b> RYYQ-T(8) / RXYQ-T(9)	○	○	○	×	○	○	○	○	> Standard total system connection ratio limit: 50 ~ 130%	
													with only VRV indoor units	✓								> 200% total system connection ratio possible under special circumstances	
●	●	●	●	●	●	●	●	●	●	●	●	●	with residential indoor units	✓	✓			✓				> Only single-module systems (RYYQ 8~20 T / RXYQ 8~20 T) > Max 32 indoor units, even on 16HP, 18HP and 20HP systems > Connection ratio: 80 ~ 130%	
													with LT Hydroboxes	✓		✓		✓				> Max 32 indoor units, even on 16HP and larger systems > Contact Daikin in case of multi-module systems (>20HP)	
													HRV units VAM-, VKM-	✓	✓	✓		✓	✓		✓		
													AHU connection EKEXV + EKEQMCBA	✓				✓	✓		✓	> Total system connection ratio with AHU is 50 ~ 110%	
													AHU connection EKEXV + EKEQFCBA							✓			
●	●	●	●	●	●	●	●	●	●	●	●	●	Biddle air curtain CYV-DK-	✓				✓	✓		✓		
													<b>VRV IV-S</b> RXYSQ-/RXYSCQ-	○	○	×	×	○	○	×	○	> Standard total system connection ratio limit: 50 ~ 130%	
													with VRV indoor units only	✓				✓	✓		✓		
													with residential indoor units only		✓							> With residential indoor: connection ratio limit: 80 ~ 130%	
													<b>VRV IV i series</b> SB.RKXYQ-T(8)	✓	×	×	×	✓	✓	×	✓	> Standard total system connection ratio limit: 50 ~ 130%	
													<b>VRV IV-C* series</b> RXYLQ-T	○	○	○	×	○	○	○	○	> Standard total system connection ratio limit: 70 ~ 130%	
●	●	●	●	●	●								with VRV indoor units only	✓				✓			✓		
													with residential indoor units only		✓							> With residential indoor: connection ratio limit: 80 ~ 130%	
													with LT hydroboxes	✓		✓		✓				> Max. 32 indoor units, contact Daikin in case of multi-module systems (> 14HP)	
													AHU connection EKEXV + EKEQMCBA	✓				✓	✓		✓	> Total system connection ratio is 70~110%	
													AHU connection EKEXV + EKEQFCBA	✓						✓		> With AHU only connection ratio is 90~110%	
													<b>VRV III-Q* series Replacement H/R</b> RQCEQ-P3	✓	×	×	×	✓	×	×	×	> Standard total system connection ratio limit: 50 ~ 130%	
													<b>VRV IV-Q Replacement H/P</b> RXYQ-T	✓	×	×	×	✓	✓	×	✓	> Standard total system connection ratio limit: 50 ~ 130%	
●	●	●	●	●	●								<b>VRV IV-W* series Water-cooled VRV</b> RWEYQ-T9	○	○	×	○	○	○	○	○	> Standard total system connection ratio limit: 50 ~ 130%	
													with VRV indoor units	✓			✓	✓	✓	✓	✓		
													with split indoor units	✓	✓			✓				> Only single-module systems (RWEYQ8-14T9) > Max 32 indoor units > Connection ratio: 80 ~ 130% > only in heat pump version	
●	●	●	●	●	●								with HT hydrobox	✓			✓						
													AHU connection	✓					✓			> Total system connection ratio with AHU + X indoor is 50 ~ 110% > Total system connection ratio with AHU only is 90~ 110%	

○ ... connection of indoor unit possible, but not necessarily simultaneously with other allowed indoor units  
 ✓ ... connection of indoor unit possible even simultaneously with other checked units in the same row  
 × ... connection of indoor not possible on this outdoor unit system



EIFFAGE ENERGIE ET EIFFAGE ENERGIE THERMIE  
OFFICE BUILDING  
VRV IV HEAT PUMP WITH CONTINUOUS HEATING



PARK PHI  
BREAM EXCELLENT OFFICE BUILDING  
WATERCOOLED VRV



VRV IV i-SERIES VRV IV HEAT PUMP  
FOR INDOOR INSTALLATION



HOTEL LE PIGONNET, 8 REPLACEMENT VRV



VRV IV S-SERIES



BASTIDE ROUGE, OFFICE BUILDING, VRV IV WITH CONTINUOUS HEATING

# VRV IV<sup>+</sup> heat recovery

Best efficiency and comfort solution

Efficient  
**3-pipe**  
system

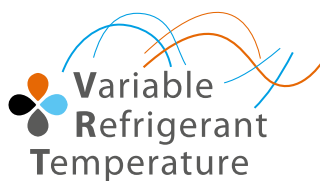

## VRV IV standards:

### Variable refrigerant temperature

Customize your VRV for best seasonal efficiency & comfort

### Continuous heating

The new standard in heating comfort

### VRV configurator

Software for simplified commissioning, configuration and customisation

- › 7 segment display
- › Automatic refrigerant charge
- › Refrigerant containment check
- › Night quiet mode
- › Low noise function
- › Connectable to LT hydrobox for hot water
- › Connectable to HT hydrobox for hot water
- › Full inverter compressors
- › Gas cooled PCB
- › 4 side heat exchanger
- › Reluctance brushless DC compressor
- › Sine wave DC inverter
- › DC fan motor
- › E-pass heat exchanger
- › I demand function
- › Manual demand function

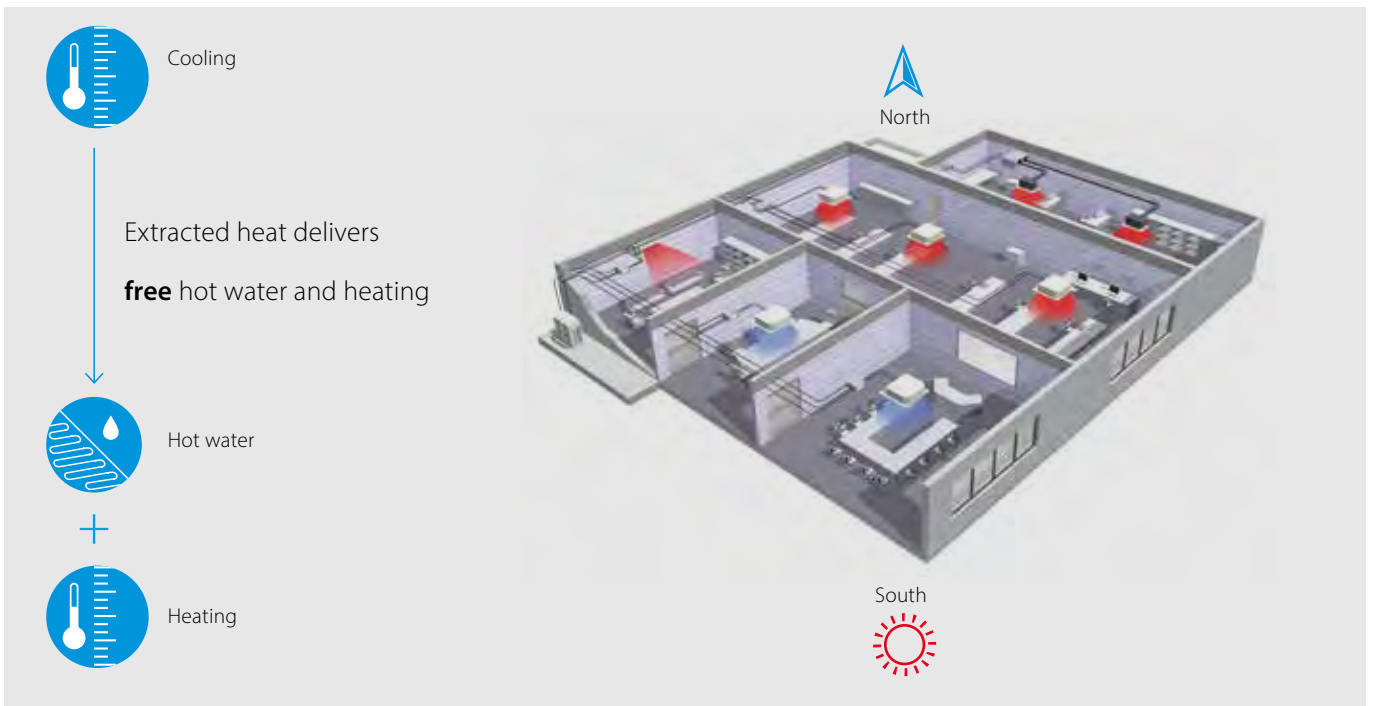

## “Free” heating and hot water production

Until now, most commercial buildings have relied on separate systems for cooling, heating, hot water and so on, which results in a lot of wasted energy.

An integrated heat recovery system reuses heat from offices, server rooms, to warm other areas or create hot water.

## Improved efficiency

In heat-recovery operation the VRV IV is up to 15% more efficient compared to VRV III. In single mode operation, the seasonal efficiency of the system can be even as much as 28% higher - thanks to the variable refrigerant temperature technology - compared to a conventional VRF system.

## Optimised Partition of Heat Exchanger for highest seasonal efficiency in heat recovery mode

Vertically divided heat exchanger with an optimized ratio for mix mode operation. This improves heat recovery efficiency by reducing radiation losses.

## Wide heating operation range

VRV IV heat recovery has a standard operation range down to  $-20^{\circ}\text{CWB}$  in heating. It can also provide cooling down to  $-20^{\circ}\text{CDB}$  for technical server rooms via field settings and specific system design.

## Maximum comfort

A VRV heat-recovery system allows simultaneous cooling and heating.

- › For hotel owners, this means a perfect environment for guests as they can freely choose between cooling or heating.
- › For offices, it means a perfect working indoor climate for both north and south-facing offices.

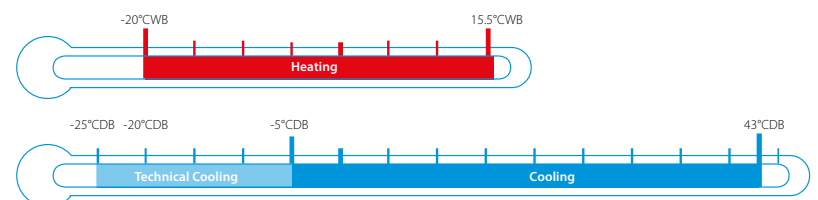
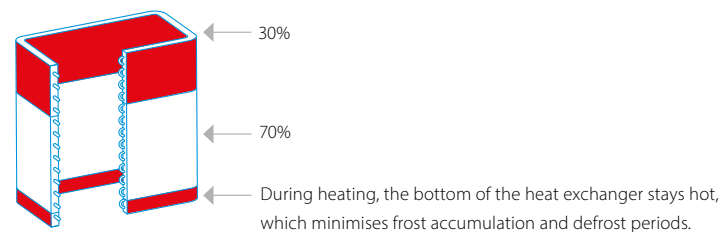
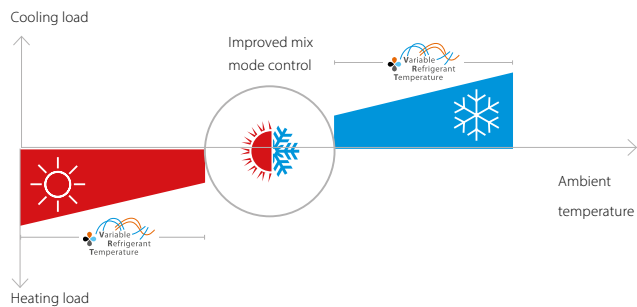

# Advantages of 3-pipe technology

## More “free” heat

Daikin 3-pipe technology needs less energy to recover heat, meaning significantly higher efficiency during heat recovery mode. Our system can recover heat at a low condensing temperature because it has dedicated gas, liquid and discharge pipes.

In a 2-pipe system, gas and liquid travel as a mixture so the condensing temperature needs to be higher in order to separate the mixed gas and liquid refrigerant. The higher condensing temperature means more energy is used to recover heat resulting in lower efficiency.

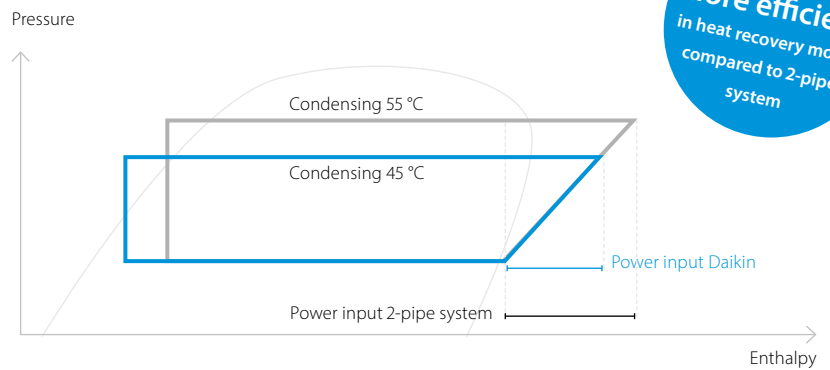

**5 to 15% more efficient** in heat recovery mode compared to 2-pipe system

## Lower pressure drop means more efficiency

- › Smooth refrigerant flow in 3-pipe system thanks to 2 smaller gas pipes results in higher energy efficiency
- › Disturbed refrigerant flow in large gas pipe on 2-pipe system results in bigger pressure drop

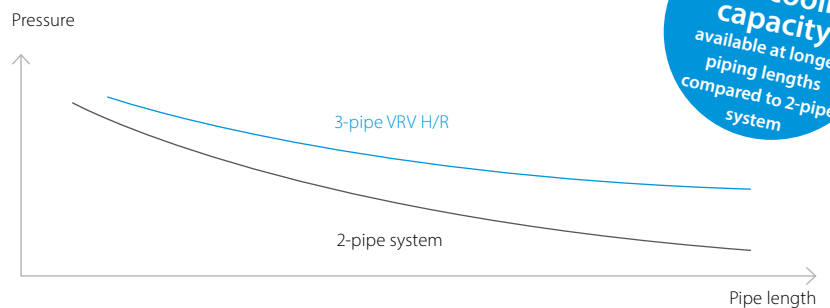

**Up to 5% more cooling capacity** available at longer piping lengths compared to 2-pipe system

## Save on refrigerant

- › Smaller diameter pipes and 3-pipe system results in up to 36% less refrigerant charge compared to 2-pipe systems, saving on refrigerant cost and reducing environmental impact

## Freely combine outdoor units

Combine outdoor units flexibly to reduce your carbon footprint, optimise your system for continuous heating, and achieve the highest efficiency.

## Flexible piping design

Total piping length	1000m
Longest length actual (Equivalent)	165m (190m)
Longest length after first branch	90m <sup>1</sup>
Level difference between indoor and outdoor units	90m <sup>1</sup>
Level difference between indoor units	30m

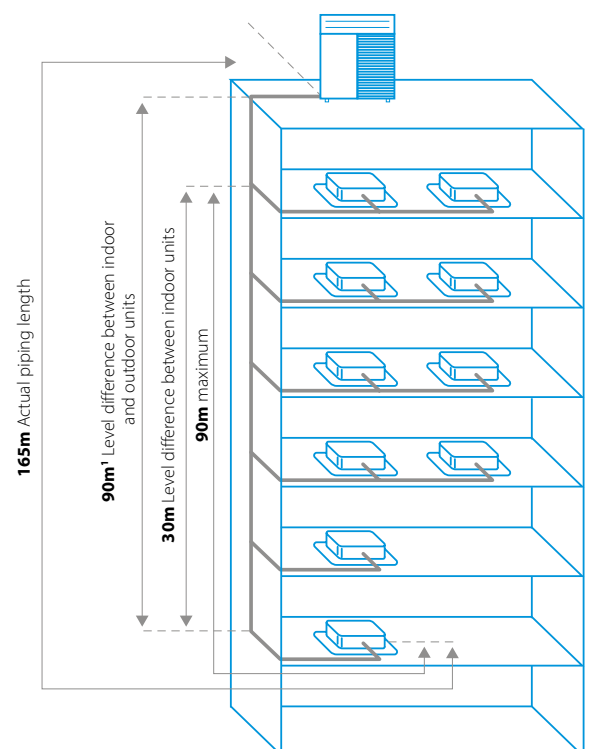

<sup>1</sup> Outdoor unit in highest position. Consult your local sales representative for restrictions on piping lengths

# Fully redesigned BS boxes

## Maximum design flexibility and installation speed

- › Quickly and flexibly design your system with a unique range of single and multi BS boxes.
- › A wide variety of compact and lightweight multi BS boxes greatly reduces installation time.
- › Free combination of single and multi BS boxes

### Single port

- › Unique to the market
- › Compact and light to install
- › No drain piping needed
- › Ideal for remote rooms
- › Technical cooling function
- › Connect up to 250 class unit (28 kW)
- › Allows multi-tenant applications



BS1Q 10, 16, 25 A

### Multi port: 4 – 6 – 8 – 10 – 12 – 16

- › Up to 55% smaller and 41% lighter than previous range
- › Faster installation thanks to a reduced number of brazing points and wiring
- › All indoor units connectable to one BS box
- › Fewer inspection ports needed
- › Up to 16 kW capacity available per port
- › Connect up to 250 class unit (28kW) by combining 2 ports
- › No limit on unused ports, permitting phased installation
- › Allows multi-tenant applications

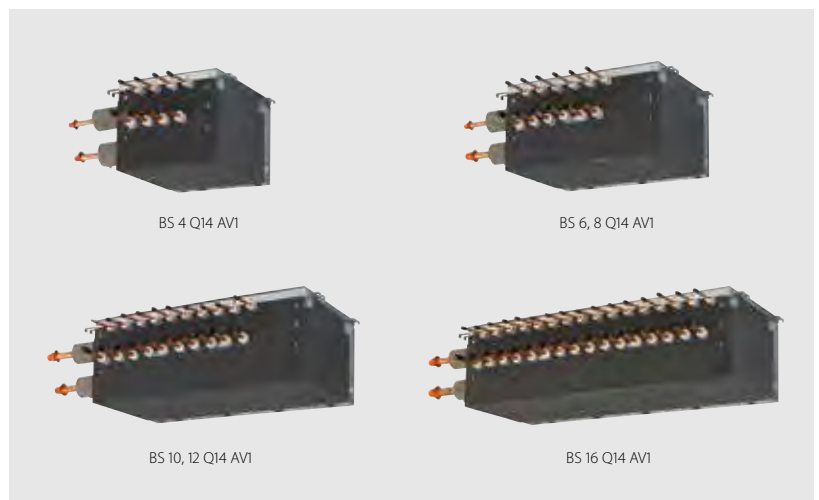

BS 4 Q14 AV1

BS 6, 8 Q14 AV1

BS 10, 12 Q14 AV1

BS 16 Q14 AV1

### Faster installation thanks to open connection

- › No need to cut the pipe before brazing – for indoor units smaller or equal to 5.6 kW (50 class)
- › Cut and braise the pipe – for indoor units bigger or equal to 7.1 kW (63 class)

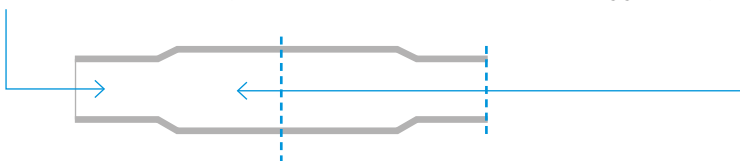

## Maximum comfort at all times

With the VRV BS box, any indoor unit not being used to switch between heating and cooling maintains the constant desired temperature. This is because our heat recovery system does not need to equalise pressure over the entire system after a change-over.

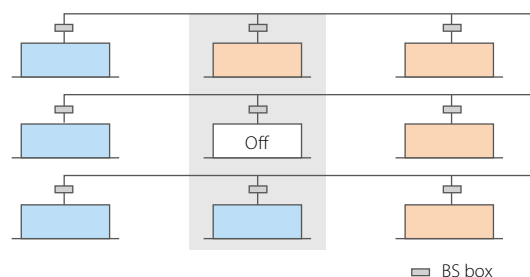

# VRV IV+ heat recovery

## Best efficiency & comfort solution

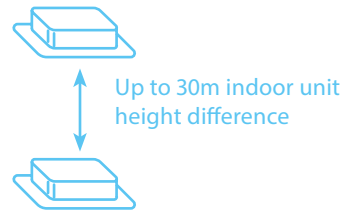

- › Fully integrated solution with heat recovery for maximum efficiency with COPs of up to 8 !
- › Covers all thermal needs of a building via a single point of contact: accurate temperature control, ventilation, hot water, air handling units and Biddle air curtains
- › „Free“ heating and hot water production provided by transferring heat from areas requiring cooling to areas requiring heating or hot water
- › The perfect personal comfort for guests/tenants via simultaneous cooling and heating
- › Incorporates VRV IV standards & technologies: Variable Refrigerant Temperature, continuous heating, VRV configurator, 7 segment display and full inverter compressors, 4-side heat exchanger, refrigerant cooled PCB, new DC fan motor
- › Outdoor unit display for quick on-site settings and

- easy read out of errors together with the indication of service parameters for checking basic functions.
- › Free combination of outdoor units to meet installation space or efficiency requirements
- › Wide piping flexibility: 30m indoor height difference, maximum piping length: 190m, total piping length: 1,000m
- › Possibility to extend the operation range in cooling down to -20°C for technical cooling operation such as server rooms
- › Contains all standard VRV features



Already fully compliant to LOT 21 - Tier 2

Published data with real-life indoor units

Access all technical information on REYQ-U at [my.daikin.eu](http://my.daikin.eu) or click here

Outdoor unit		REYQ	8U	10U	12U	14U	16U	18U	20U	
Capacity range		HP	8	10	12	14	16	18	20	
Cooling capacity	Prated,c	kW	22.4	28.0	33.5	40.0	45.0	50.4	52.0	
Heating capacity	Prated,h	kW	13.7	16.0	18.4	20.6	23.2	27.9	31.0	
	Max. 6°CWB	kW	25.0	31.5	37.5	45.0	50.0	56.5	63.0	
Recommended combination			4xXFQ50AVEB	4xXFQ63AVEB	6xXFQ50AVEB	1xXFQ50AVEB + 5xXFQ63AVEB	4xXFQ63AVEB + 1xXFQ80AVEB	3xXFQ50AVEB + 5xXFQ63AVEB	2xXFQ50AVEB + 6xXFQ63AVEB	
ηs,c		%	286.1	264.8	257.0	255.8	243.1	250.6	246.7	
ηs,h		%	165.1	169.7	183.8	168.3	167.5	172.5	162.7	
SEER			7.2	6.7	6.5	6.5	6.2	6.3	6.2	
SCOP			4.2	4.3	4.7	4.3	4.3	4.4	4.1	
Maximum number of connectable indoor units			64							
Indoor index connection	Min.		100.0	125.0	150.0	175.0	200.0	225.0	250.0	
	Nom.		-							
	Max.		260.0	325.0	390.0	455.0	520.0	585.0	650.0	
Dimensions	Unit	HeightxWidthxDepth	mm				mm			
			1,685x930x765				1,685x1,240x765			
Weight	Unit		kg		kg		kg		kg	
			230		230		314		317	
Sound power level	Cooling	Nom.	dBA		dBA		dBA		dBA	
			78.0		79.1		83.4		80.9	
Sound pressure level	Cooling	Nom.	dBA		dBA		dBA		dBA	
			57.0		57.0		61.0		60.0	
Operation range	Cooling	Min.~Max.	°CDB						°CDB	
			-5.0~43.0						-5.0~43.0	
Refrigerant	Heating	Min.~Max.	°CWB						°CWB	
			-20.0~15.5						-20.0~15.5	
Refrigerant		Type/GWP	R-410A/2,087.5							
Charge		kg/TCO2Eq	9.7/20.2		9.8/20.5		9.9/20.7		11.8/24.6	
Piping connections	Liquid	OD	mm		mm		mm		mm	
			9.52		12.7		15.9		15.9	
	Gas	OD	mm		mm		mm		mm	
			19.1		22.2		28.6		28.6	
	HP/LP gas	OD	mm		mm		mm		mm	
			15.9		19.1		22.2		28.6	
Total piping length	System		m							
	Actual		1,000							
Power supply		Phase/Frequency/Voltage	Hz/V							
			3N~/50/380-415							
Current - 50Hz		Maximum fuse amps (MFA)	A		A		A		A	
			20		25		32		40	

Outdoor unit System		REYQ	10U	13U	16U	18U	20U	22U	24U	26U	28U	30U	32U	
System	Outdoor unit module 1		REMQ5U		REYQ8U		REYQ10U		REYQ8U		REYQ12U		REYQ16U	
	Outdoor unit module 2		REMQ5U		REYQ8U		REYQ10U		REYQ12U		REYQ14U		REYQ18U	
Capacity range		HP	10	13	16	18	20	22	24	26	28	30	32	
Cooling capacity	Prated,c	kW	28.0	36.4	44.8	50.4	55.9	61.5	67.4	73.5	78.5	83.9	90.0	
Heating capacity	Prated,h	kW	16.0	21.7	23.2	27.9	31.0	34.4	36.9	37.1	39.7	44.4	46.4	
	Max. 6°CWB	kW	32.0	41.0	50.0	56.5	62.5	69.0	75.0	82.5	87.5	94.0	100.0	
Recommended combination			4xXFQ63AVEB	3xXFQ50AVEB + 3xXFQ63AVEB	4xXFQ63AVEB + 2xXFQ80AVEB	4xXFQ50AVEB + 4xXFQ63AVEB	10xXFQ50AVEB	6xXFQ50AVEB + 4xXFQ63AVEB	4xXFQ50AVEB + 4xXFQ63AVEB + 2xXFQ80AVEB	7xXFQ50AVEB + 5xXFQ63AVEB	6xXFQ50AVEB + 4xXFQ63AVEB + 2xXFQ80AVEB	9xXFQ50AVEB + 5xXFQ63AVEB	8xXFQ63AVEB + 4xXFQ80AVEB	
ηs,c		%	275,1	301,3	288,6	272,9	266,0	260,4	257,7	257,5	251,9	266,8	243,1	
ηs,h		%	158,8	160,6	168,2	167,9	175,7	178,5	167,6	175,5	174,8	179,4	169,1	
SEER			7,0	7,6	7,3	6,9	6,7	6,6	6,5	6,5	6,4	6,7	6,2	
SCOP			4,0	4,1	4,3	4,3	4,5	4,5	4,3	4,5	4,4	4,6	4,3	
Maximum number of connectable indoor units			64											
Indoor index connection	Min.		125.0	163.0	200.0	225.0	250.0	275.0	300.0	325.0	350.0	375.0	400.0	
	Nom.		-											
	Max.		325.0	423.0	520.0	585.0	650.0	715.0	780.0	845.0	910.0	975.0	1,040.0	
Piping connections	Liquid	OD	mm		mm		mm		mm		mm		mm	
			9.52		12.7		15.9		19.1		19.1		19.1	
	Gas	OD	mm		mm		mm		mm		mm		mm	
			22.2		28.6		34.9		34.9		34.9		34.9	
	HP/LP gas	OD	mm		mm		mm		mm		mm		mm	
			19.1		22.2		28.6		28.6		28.6		28.6	
Total piping length	System		m											
	Actual		500											
Power supply		Phase/Frequency/Voltage	Hz/V											
			3N~/50/380-415											
Current - 50Hz		Maximum fuse amps (MFA)	A		A		A		A		A		A	
			40		50		63		80		80		80	

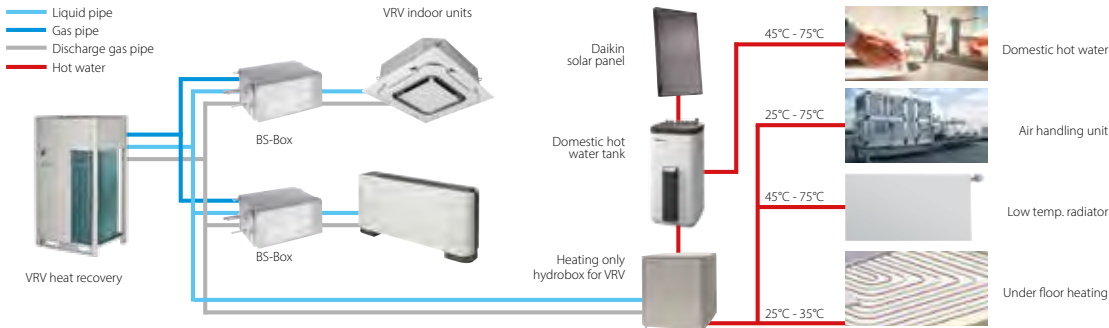

Outdoor unit System + Module		REYQ	34U	36U	38U	40U	42U	44U	46U	48U	50U	52U	54U	
System	Outdoor unit module 1		REYQ16U		REYQ8U	REYQ10U		REYQ12U	REYQ14U	REYQ16U		REYQ18U		
	Outdoor unit module 2		REYQ18U		REYQ20U		REYQ12U		REYQ16U				REYQ18U	
	Outdoor unit module 3		-		REYQ18T		REYQ16T						REYQ18T	
Capacity range		HP	34	36	38	40	42	44	46	48	50	52	54	
Cooling capacity	Prated,c	kW	95.4	97.0	106.3	111.9	118.0	123.5	130.0	135.0	140.4	145.8	151.2	
Heating capacity	Prated,h	kW	51.1	54.2	58.1	58.9	60.9	62.9	67.0	69.6	74.3	79.0	83.7	
	Max. 6°CWB	kW	106.5	113.0	119.0	125.5	131.5	137.5	145.0	150.0	156.5	163.0	169.5	
Recommended combination			3x FXFQ30AVEB +9x FXFQ3AVEB +2x FXFQ8AVEB	2x FXFQ30AVEB +10x FXFQ3AVEB +2x FXFQ8AVEB	6x FXFQ30AVEB +10x FXFQ3AVEB	9x FXFQ30AVEB +9x FXFQ3AVEB	12x FXFQ3AVEB +4x FXFQ8AVEB	6x FXFQ30AVEB +8x FXFQ3AVEB +4x FXFQ8AVEB	1x FXFQ30AVEB +13x FXFQ3AVEB +4x FXFQ8AVEB	12x FXFQ3AVEB +6x FXFQ8AVEB	3x FXFQ30AVEB +13x FXFQ3AVEB +4x FXFQ8AVEB	6x FXFQ30AVEB +14x FXFQ3AVEB +2x FXFQ8AVEB	9x FXFQ30AVEB +15x FXFQ3AVEB	
ηs,c		%	259,2	255,3	269,2	259,6	250,2	249,3	246,8	243,1	254,4	265,7	275,2	
ηs,h		%	172,0	166,3	176,0	176,1	167,8	171,9	168,8	168,5	170,3	171,7	173,3	
SEER			6,6	6,5	6,8	6,6	6,3	6,3	6,2	6,2	6,4	6,7	7,0	
SCOP			4,4	4,2	4,5	4,5	4,3	4,4	4,3	4,3	4,3	4,4	4,4	
Maximum number of connectable indoor units			64											
Indoor index connection	Min.		425.0	450.0	475.0	500.0	525.0	550.0	575.0	600.0	625.0	650.0	675.0	
	Nom.		-											
	Max.		1,105.0	1,170.0	1,235.0	1,300.0	1,365.0	1,430.0	1,495.0	1,560.0	1,625.0	1,690.0	1,755.0	
Piping connections	Liquid	OD	mm					19.1						
	Gas	OD	mm		34.9			41.3						
	HP/LP gas	OD	mm		28.6			34.9						
	Total piping length	System Actual	m					1,000						
Power supply	Phase/Frequency/Voltage		Hz/V 3N~/50/380-415											
Current - 50Hz	Maximum fuse amps (MFA)		A 80			100			125					
Outdoor unit module		REMQR	5U											
Dimensions	Unit	HeightxWidthxDepth	mm 1,685x930x765											
Weight	Unit		kg 230											
Fan	External static pressure	Max.	Pa 78											
Sound power level	Cooling	Nom.	dBA 78.0											
Sound pressure level	Cooling	Nom.	dBA 57.0											
Operation range	Cooling	Min.~Max.	°CDB -5.0~43.0											
	Heating	Min.~Max.	°CWB -20.0~15.5											
Refrigerant	Type/GWP		R-410A/2,087.5											
	Charge		kg/CO2Eq 9.7/20.2											
Power supply	Phase/Frequency/Voltage		Hz/V 3N~/50/380-415											
Current - 50Hz	Maximum fuse amps (MFA)		A 20											

(1) Actual number of connectable indoor units depends on the indoor unit type and the connection ratio restriction for the system (50% ≤ CR ≤ 120%)

## Individual branch selector for VRV IV heat recovery

- › Unique range of single and multi BS boxes for flexible and fast design
- › Compact & light to install
- › Ideal for remote rooms as no drain piping is needed
- › Allows integration of server rooms into the heat recovery solution thanks to technical cooling function
- › Connect up to 250 class unit (28kW)
- › **UNIQUE** Faster installation thanks to open port connection
- › Allows multi tenant applications
- › Connectable to REYQ-T, RQCEQ-P3 and RWEYQ-T9 heat recovery units



Access all technical information on BS1Q-A at [my.daikin.eu](http://my.daikin.eu) or click here

Indoor unit				BS	1Q10A	1Q16A	1Q25A
Power input	Cooling	Nom.		kW		0.005	
	Heating	Nom.		kW		0.005	
Maximum number of connectable indoor units					6		8
Maximum capacity index of connectable indoor units					15 < x ≤ 100	100 < x ≤ 160	160 < x ≤ 250
Dimensions	Unit	Height	Width	Depth	mm		
Weight	Unit						kg
Casing	Material						
Piping connections	Outdoor unit	Liquid	OD	mm			
		Gas	OD	mm			
		Discharge gas	OD	mm			
	Indoor unit	Liquid	OD	mm			
		Gas	OD	mm			
				mm			
Sound absorbing thermal insulation				Foamed polyurethane Flame-resistant needle felt			
Power supply	Phase			1~			
	Frequency			Hz			
	Voltage			V			
	Maximum fuse amps (MFA)			A			



# Multi branch selector for VRV IV heat recovery

- › Unique range of single and multi BS boxes for flexible and fast design
- › Major reduction in installation time thanks to wide range, compact size and light weight multi BS boxes
- › Up to 70% smaller and 66% lighter than previous series
- › Faster installation thanks to a reduced number of brazing points and wiring
- › All indoor units connectable to one BS box
- › Less inspection ports needed compared to installing single BS boxes
- › Up to 16kW capacity available per port
- › Connect up to 250 class unit (28kW) by combining 2 ports
- › No limit on unused ports allowing phased installation
- › **UNIQUE** Faster installation thanks to open port connection
- › **UNIQUE** Refrigerant filters for high reliability
- › Allows multi tenant applications
- › Connectable to REYQ-T, RQCEQ-P3 and RWEYQ-T9 heat recovery units

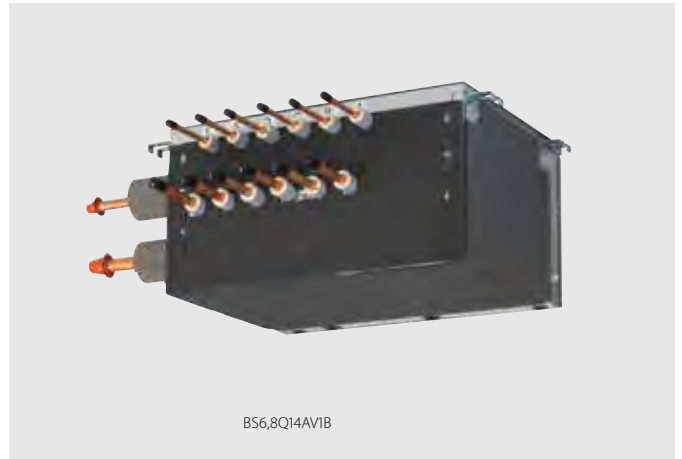

Outdoor Units



Access all technical information on BS-Q14AV1B at [my.daikin.eu](http://my.daikin.eu) or click here

Indoor unit				BS	4Q14AV1B	6Q14AV1B	8Q14AV1B	10Q14AV1B	12Q14AV1B	16Q14AV1B
Power input	Cooling	Nom.	kW	0.043	0.064	0.086	0.107	0.129	0.172	
	Heating	Nom.	kW	0.043	0.064	0.086	0.107	0.129	0.172	
Maximum number of connectable indoor units				20	30	40	50	60	64	
Maximum number of connectable indoor units per branch				5						
Number of branches				4	6	8	10	12	16	
Maximum capacity index of connectable indoor units				400	600	750				
Maximum capacity index of connectable indoor units per branch				140						
Dimensions	Unit	HeightxWidthxDepth	mm	298x370x430	298x580x430		298x820x430		298x1,060x430	
Weight	Unit		kg	17	24	26	35	38	50	
Casing	Material			Galvanised steel plate						
Piping connections	Outdoor unit	Liquid	OD	mm	9.5	12.7	12.7 / 15.9	15.9	15.9 / 19.1	19.1
		Gas	OD	mm	22.2 / 19.1	28.6 / 22.2	28.6	28.6 / 34.9		34.9
		Discharge gas	OD	mm	19.1 / 15.9	19.1 / 22.2	19.1 / 22.2 / 28.6	28.6		
	Indoor unit	Liquid	OD	mm	9.5 / 6.4					
		Gas	OD	mm	15.9 / 12.7					
	Drain				VP20 (I.D. 20/O.D. 26)					
Sound absorbing thermal insulation				Urethane foam, polyethylene foam						
Power supply	Phase			1~						
	Frequency			Hz						
	Voltage			V						
	Maximum fuse amps (MFA)			A						
				15						

# VRV IV<sup>+</sup> heat pump

Daikin's optimum solution  
with top comfort

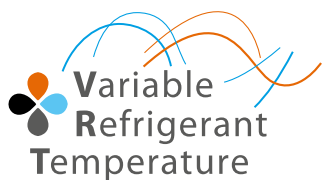
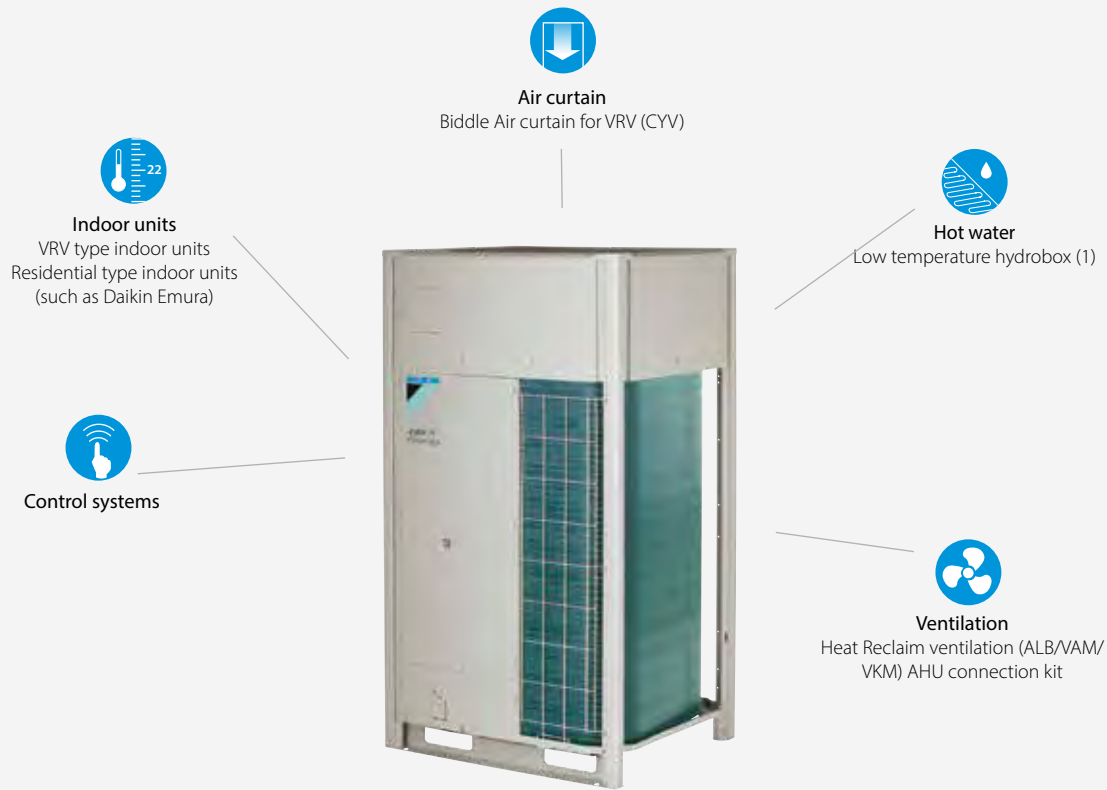

## VRV IV standards:

### Variable refrigerant temperature

Customize your VRV for best seasonal efficiency & comfort

### Continuous heating

The new standard in heating comfort

### VRV configurator

Software for simplified commissioning, configuration and customisation

- > 7 segment display
- > Automatic refrigerant charge
- > Refrigerant containment check
- > Night quiet mode
- > Low noise function
- > Connectable to stylish indoor units (Only for single modules)
- > Connectable to LT hydrobox (1)
- > Full inverter compressors
- > Gas cooled PCB
- > 4 side heat exchanger
- > Reluctance brushless DC compressor
- > Sine wave DC inverter
- > DC fan motor
- > E-pass heat exchanger
- > I demand function
- > Manual demand function

(1) Special order unit needed to connect LT hydroboxes with multi outdoor unit systems  
For detailed explanation of these functions refer to vriv iv technologies tab



## Wide range of indoor units

Freely combine VRV indoor units with stylish indoor units (Daikin Emura, Nexura, ...)

Mix of  
RA units  
& VRV units



Connectable stylish indoor units

		15 CLASS	20 CLASS	25 CLASS	35 CLASS	42 CLASS	50 CLASS	60 CLASS	71 CLASS
Daikin Emura - Wall mounted unit	FTXJ-MW/MS		•	•	•		•		
Wall mounted unit	CTXM-M	•			•				
Wall mounted unit	FTXM-N		•	•	•	•	•	•	•
Nexura - Floor standing unit	FVXG-K			•	•		•		
Floor standing unit	FVXM-F			•	•		•		
Flexi type unit	FLXS-B(9)			•	•		•	•	

BPMKS box needed to connect RA indoors to VRV IV (RYYQ / RXYQ)

# VRV IV

# proven in practice: 40% more efficient

**A field trial at a German fashion chain store demonstrated how the innovative features of VRV IV have improved energy efficiency dramatically over previous models.**

## Results: up to 60% less energy consumed

The results of the trial showed that the new VRV IV system consumed much less energy, particularly when cooling, compared with the VRV III system – in some cases up to 60% less. When heating, savings were an average of 20%.

The Unterhaching trial demonstrates how VRV IV heat pump technology uses a renewable energy source – air - to provide a complete and environmentally sustainable solution for heating, cooling, and ventilation in commercial environments. The trial also shows that businesses can only identify and control energy wastage through careful and intelligent monitoring of climate control systems, a service which Daikin can offer.

Average daily consumption during working hours in kWh

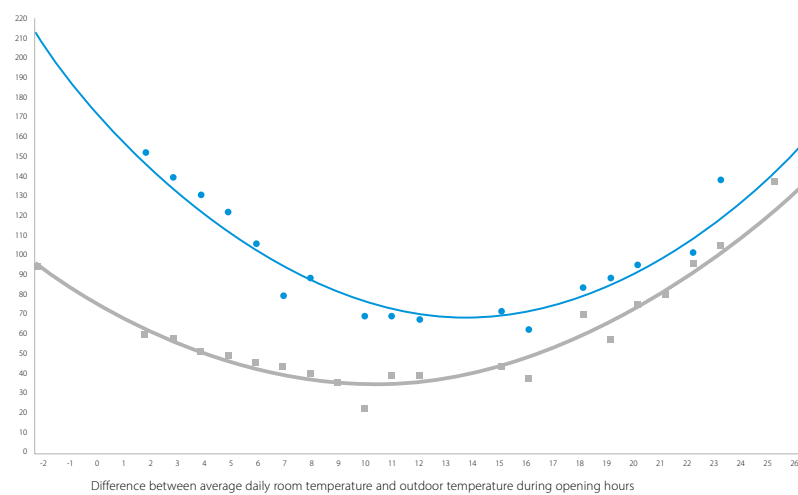

- Energy use VRV III in 2012 in kWh
- Energy use VRV IV in 2013 in kWh
- Trendline energy use VRV III
- Trendline energy use VRV IV

	VRV III 20HP (2 modules)	VRV IV 18HP (1 module)
<b>Period</b>	March 2012 - February 2013	March 2013 - February 2014
<b>Avg (kWh/Month)</b>	2.797	1.502
<b>Total (KWh)</b>	33.562	18.023
<b>Total (€)</b>	6.041	3.244
<b>Yearly (operation cost/m<sup>2</sup> (€/m<sup>2</sup>))</b>	<b>9,9</b>	<b>5,3</b>
<b>46% savings = € 2.797</b>		

## Measured data

### Fashion store Unterhaching (Germany)

- › Floor space: 607m<sup>2</sup>
- › Energy cost: 0,18 €/kWh
- › System taken into account for consumption:
  - VRV IV heat pump with continuous heating
  - Round flow cassettes (without auto cleaning panel)
  - VAM for ventilation (2x VAM2000)
  - Biddle Air curtain.



## Free combination of outdoor units

Freely combine outdoor units to optimise for small footprint, continuous heating, highest efficiency or any other combination

## Flexible piping design

Total piping length	1000m
Longest length actual (Equivalent)	165m (190m)
Longest length after first branch	90m <sup>1</sup>
Level difference between indoor and outdoor units	90m <sup>1</sup>
Level difference between indoor units	30m

<sup>1</sup> Contact your local dealer for more information and restrictions  
<sup>2</sup> in case outdoor unit is located below indoor units

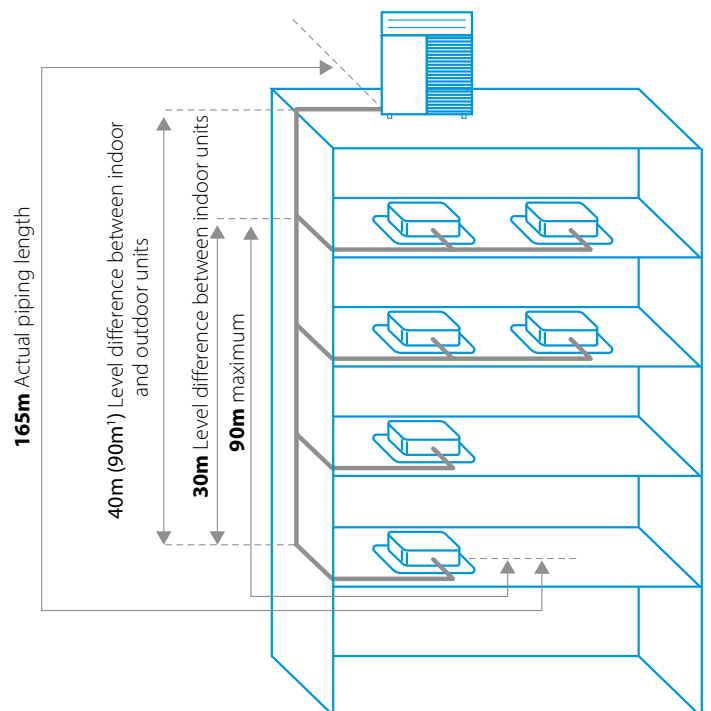

# VRV IV+ heat pump

## Daikin's optimum solution with top comfort

- › Covers all thermal needs of a building via a single point of contact: accurate temperature control, ventilation, hot water, air handling units and Biddle air curtains
- › Wide range of indoor units: possibility to combine VRV with stylish indoor units (Daikin Emura, Nexura, ...)
- › Incorporates VRV IV standards & technologies: Variable Refrigerant Temperature, continuous heating, VRV configurator, 7 segment display and full inverter compressors, 4-side heat exchanger, refrigerant cooled PCB, new DC fan motor

- › Outdoor unit display for quick on-site settings and easy read out of errors together with the indication of service parameters for checking basic functions.
- › Free combination of outdoor units to meet installation space or efficiency requirements
- › Available as heating only by irreversible field setting
- › Contains all standard VRV features

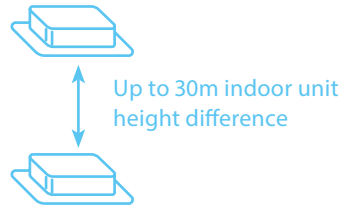

Already fully compliant  
to LOT 21 - Tier 2

**Published data with  
real-life indoor units**

Access all technical information on RYYQ-U at [my.daikin.eu](http://my.daikin.eu) or click here

Access all technical information on RXYQ-U at [my.daikin.eu](http://my.daikin.eu) or click here

Outdoor unit		RYYQ/RXYQ	8U	10U	12U	14U	16U	18U	20U		
Capacity range		HP	8	10	12	14	16	18	20		
Cooling capacity	Prated,c	kW	22.4	28.0	33.5	40.0	45.0	50.4	52.0		
Heating capacity	Prated,h	kW	13.7	16.0	18.4	20.6	23.2	27.9	31.0		
	Max. 6°CWB	kW	25.0	31.5	37.5	45.0	50.0	56.5	63.0		
Recommended combination			4 x FXFQ50AVEB	4 x FXFQ63AVEB	6 x FXFQ50AVEB	1 x FXFQ50AVEB + 5 x FXFQ63AVEB	4 x FXFQ63AVEB + 2 x FXFQ80AVEB	3 x FXFQ50AVEB + 5 x FXFQ63AVEB	2 x FXFQ50AVEB + 6 x FXFQ63AVEB		
ηs,c		%	302.4	267.6	247.8	250.7	236.5	238.3	233.7		
ηs,h		%	167.9	168.2	161.4	155.4	157.8	163.1	156.6		
SEER			7.6	6.8		6.3		6.0	5.9		
SCOP			4.3		4.1	4.0		4.2	4.0		
Maximum number of connectable indoor units						64 <sup>(1)</sup>					
Indoor index connection	Min.		100.0	125.0	150.0	175.0	200.0	225.0	250.0		
	Nom.										
	Max.		260.0	325.0	390.0	455.0	520.0	585.0	650.0		
Dimensions	Unit	HeightxWidthxDepth	mm			mm					
			1,685x930x765			1,685x1,240x765					
Weight	Unit		kg			kg		kg			
			252 (RYYQ) / 198 (RXYQ)			319 (RYYQ) / 275 (RXYQ)		378 (RYYQ) / 308 (RXYQ)			
Sound power level	Cooling	Nom.	dBA		78.0	79.1	83.4	80.9	85.6	83.8	87.9
Sound pressure level	Cooling	Nom.	dBA		57.0		61.0	60.0	63.0	62.0	65.0
Operation range	Cooling	Min.~Max.	°CDB		-5.0~43.0						
	Heating	Min.~Max.	°CWB		-20.0~15.5						
Refrigerant	Type/GWP		R-410A/2,087.5								
	Charge	kg/TCO2Eq	5.9/12.3	6.0/12.5	6.3/13.2	10.3/21.5	10.4/21.7	11.7/24.4	11.8/24.6		
Piping connections	Liquid	OD	mm		9.52		12.7		15.9		
	Gas	OD	mm		19.1	22.2	28.6				
	Total piping length	System Actual	m		1,000						
Power supply	Phase/Frequency/Voltage		Hz/V								
			3N~/50/380-415								
Current - 50Hz	Maximum fuse amps (MFA)	A	20	25	32		40		50		

Outdoor unit System		RYYQ/RXYQ	22U	24U	26U	28U	30U	32U	34U	36U	38U
System	Outdoor unit module 1		10	8		12			16		8
	Outdoor unit module 2		12	16	14	16	18	16	18	20	10
	Outdoor unit module 3										
Capacity range		HP	22	24	26	28	30	32	34	36	38
Cooling capacity	Prated,c	kW	61.5	67.4	73.5	78.5	83.9	90.0	95.4	97.0	102.4
Heating capacity	Prated,h	kW	34.4	36.9	39.0	41.6	46.3	46.4	51.1	54.2	60.7
	Max. 6°CWB	kW	69.0	75.0	82.5	87.5	94.0	100.0	106.5	113.0	119.5
Recommended combination			6 x FXFQ50AVEB + 4 x FXFQ63AVEB	4 x FXFQ50AVEB + 4 x FXFQ63AVEB + 2 x FXFQ80AVEB	7 x FXFQ50AVEB + 5 x FXFQ63AVEB	6 x FXFQ50AVEB + 4 x FXFQ63AVEB + 2 x FXFQ80AVEB	9 x FXFQ50AVEB + 5 x FXFQ63AVEB	8 x FXFQ63AVEB + 4 x FXFQ80AVEB	3 x FXFQ50AVEB + 9 x FXFQ63AVEB + 2 x FXFQ80AVEB	2 x FXFQ50AVEB + 10 x FXFQ63AVEB + 2 x FXFQ80AVEB	6 x FXFQ50AVEB + 10 x FXFQ63AVEB
ηs,c		%	274.5	269.9	264.2	257.8	256.8	251.7	253.3	250.8	272.4
ηs,h		%	171.2	167.0	164.6	166.0	169.8	163.1	166.2	162.4	167.5
SEER			6.9	6.8	6.7		6.5		6.4	6.3	6.9
SCOP			4.4	4.3	4.2		4.3	4.2		4.1	4.3
Maximum number of connectable indoor units						64 <sup>(1)</sup>					
Indoor index connection	Min.		275.0	300.0	325.0	350.0	375.0	400.0	425.0	450.0	475.0
	Nom.										
	Max.		715.0	780.0	845.0	910.0	975.0	1,040.0	1,105.0	1,170.0	1,235.0
Piping connections	Liquid	OD	mm		15.9		19.1		41.3		
	Gas	OD	mm		28.6	34.9					
	Total piping length	System Actual	m		1,000						
Power supply	Phase/Frequency/Voltage		Hz/V								
			3N~/50/380-415								
Current - 50Hz	Maximum fuse amps (MFA)	A	63					80		100	

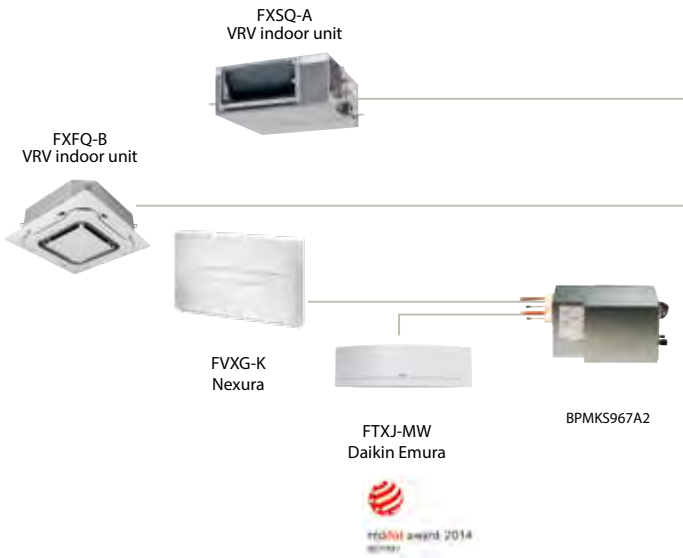

RYYQ8-12U/RXYQ8-12U

Connectable stylish indoor units

		15 CLASS	20 CLASS	25 CLASS	35 CLASS	42 CLASS	50 CLASS	60 CLASS	71 CLASS
Daikin Emura - Wall mounted unit	FTXJ-MW/MS		●	●	●		●		
Wall mounted unit	CTXM-M	●			●				
Wall mounted unit	FTXM-N		●	●	●	●	●	●	●
Nexura - Floor standing unit	FVXG-K			●	●		●		
Floor standing unit	FVXM-F			●	●		●		
Flexi type unit	FLXS-B(9)			●	●		●	●	

BPMKS box needed to connect RA indoors to VRV IV (RYYQ / RXYQ)

Outdoor unit System		RYYQ/RXYQ	40U	42U	44U	46U	48U	50U	52U	54U
System	Outdoor unit module 1		10		12	14	16		18	
	Outdoor unit module 2		12	16				18		
	Outdoor unit module 3		18	16				18		
Capacity range	HP	40	42	44	46	48	50	52	54	
Cooling capacity	Prated,c	kW	111.9	118.0	123.5	130.0	135.0	140.4	145.8	151.2
Heating capacity	Prated,h	kW	62.3	62.4	64.8	67.0	69.6	74.3	79.0	83.7
	Max. 6°CWB	kW	125.5	131.5	137.5	145.0	150.0	156.5	163.0	169.5
Recommended combination			9 x FXFQ50AVEB + 9 x FXFQ63AVEB	12 x FXFQ63AVEB + 4 x FXFQ80AVEB	6 x FXFQ50AVEB + 8 x FXFQ63AVEB + 4 x FXFQ80AVEB	1 x FXFQ50AVEB + 13 x FXFQ63AVEB + 4 x FXFQ80AVEB	12 x FXFQ63AVEB + 6 x FXFQ80AVEB	3 x FXFQ50AVEB + 13 x FXFQ63AVEB + 4 x FXFQ80AVEB	6 x FXFQ50AVEB + 14 x FXFQ63AVEB + 2 x FXFQ80AVEB	9 x FXFQ50AVEB + 15 x FXFQ63AVEB
ηs,c	%	263.5	261.2	255.9	254.9	251.7	252.8	253.7	254.1	
ηs,h	%	170.0	165.5	164.5	162.0	162.8	165.2	167.2	169.4	
SEER		6.7	6.6	6.5			6.4			
SCOP		4.3	4.2		4.1		4.2	4.3		
Maximum number of connectable indoor units			64 <sup>(1)</sup>							
Indoor index connection	Min.		500.0	525.0	550.0	575.0	600.0	625.0	650.0	675.0
	Nom.									
	Max.		1,300.0	1,365.0	1,430.0	1,495.0	1,560.0	1,625.0	1,690.0	1,755.0
Piping connections	Liquid OD	mm	19.1							
	Gas OD	mm	41.3							
	Total piping length	System Actual	1,000							
Power supply	Phase/Frequency/Voltage	Hz/V	3N~/50/380-415							
Current - 50Hz	Maximum fuse amps (MFA)	A	100				125			
Outdoor unit module for continuous heating combinations		RVMQ	8U	10U	12U	14U	16U	18U	20U	
Dimensions	Unit HeightxWidthxDepth	mm	1,685x930x765				1,685x1,240x765			
Weight	Unit	kg	198			275		308		
Fan	External static pressure	Max. Pa	78							
Sound power level	Cooling	Nom. dBA	78.0	79.1	83.4	80.9	85.6	83.8	87.9	
	Heating	Nom. dBA	57.0		61.0	60.0	63.0	62.0	65.0	
Operation range	Cooling	Min.~Max. °CDB	-5.0~43.0							
	Heating	Min.~Max. °CWB	-20.0~15.5							
Refrigerant	Type/GWP		R-410A/2,087.5							
	Charge	kg/TCO2Eq	5.9/12.3	6.0/12.5	6.3/13.2	10.3/21.5	11.3/23.6	11.7/24.4	11.8/24.6	
Power supply	Phase/Frequency/Voltage	Hz/V	3N~/50/380-415							
Current - 50Hz	Maximum fuse amps (MFA)	A	20	25	32	40		50		

(1) Actual number of connectable indoor units depends on the indoor unit type (VRV indoor, Hydrobox, RA indoor, etc.) and the connection ratio restriction for the system (50% ≤ CR ≤ 130%)

# VRV IV S-series heat pump

## The most compact VRV

Most compact unit on the market  
823mm high & 94kg



Control systems



Indoor units

VRV type indoor units  
Residential type indoor units  
(such as Daikin Emura)



Air curtain

Biddle Air curtain for VRV (CYV)



Ventilation

Heat Reclaim ventilation  
ALB/VAM/VKM AHU  
connection kit



RXYSQ4, 5TV1



RXYSQ4, 5, T8V/T8Y



RXYSQ8, 10, 12TY1

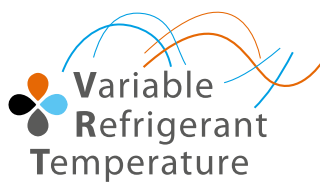

### VRV IV standards:

### Variable refrigerant temperature

Customize your VRV for best seasonal efficiency & comfort

### VRV configurator

Software for simplified commissioning, configuration and customisation

- > Refrigerant containment check
- > Night quiet mode
- > Low noise function
- > Connectable to stylish indoor units (Daikin Emura, Nexura)
- > Full inverter compressors
- > Gas cooled PCB (not available on RXYSQ4,5,6,8 T8Y/TY1)
- > Reluctance brushless DC compressor
- > Sine wave DC inverter
- > DC fan motor
- > E-pass heat exchanger
- > I demand function
- > Manual demand function

For detailed explanation of these functions refer to vrv iv technologies tab



## Widest range of front blow units on the market



## Lowest height on the market

### Ideal for roof installations

› The low height mini VRV can be hidden in many places where a twin fan unit cannot due to its low height.

### Ideal to install below a window on a Balcony

› Daikin VRV IV S-series compact can be installed discretely on a balcony thanks to its compact dimensions, offering you air conditioning while being almost unnoticeable.



Unnoticeable for parapet installation



Low height make the unit invisible from inside and unnoticeable from the outside



## Space saving design

The VRV S-series is slimmer and more compact, resulting in significant savings in installation space.





## Wide range of indoor units

Connect VRV units...



... or stylish indoor units (RA and Sky Air)

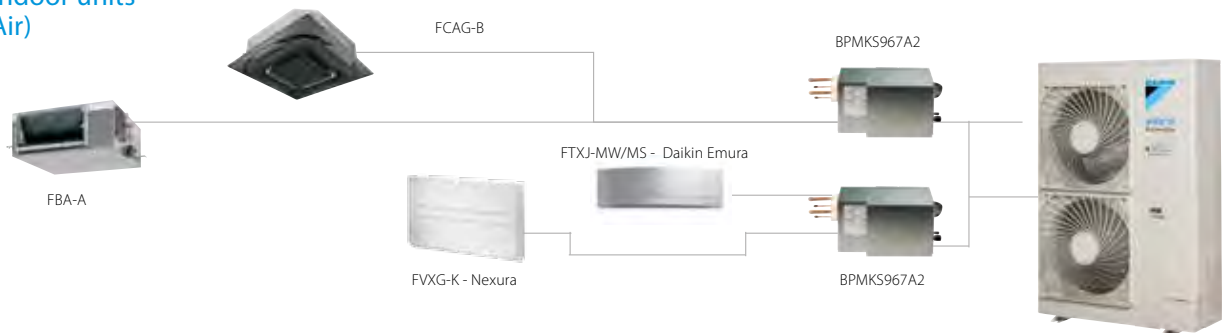

## Connectable stylish indoor units

		15 CLASS	20 CLASS	25 CLASS	35 CLASS	42 CLASS	50 CLASS	60 CLASS	71 CLASS
Round flow cassette	FCAG-B				•		•	•	•
Fully flat cassette	FFA-A9			•	•		•	•	
Slim concealed ceiling unit	FDXM-F9			•	•		•	•	
Concealed ceiling unit with inverter driven fan	FBA-A(9)			•	•		•	•	
Daikin Emura - Wall mounted unit	FTXJ-MW/MS		•	•	•		•		
Wall mounted unit	CTXM-M	•			•				
Wall mounted unit	FTXM-N		•	•	•	•	•	•	•
Ceiling suspended unit	FHA-A(9)				•		•	•	
Nexura - Floor standing unit	FVXG-K			•	•		•		
Floor standing unit	FVXM-F			•	•		•		
Concealed floorstanding unit	FNA-A9			•	•		•	•	
Flexi type unit	FLXS-B(9)			•	•		•	•	

For more info about Daikins stylish indoor units, please check our indoor unit-portfolio

\* VRV indoor units and stylish indoor units cannot be combined.

\* To connect stylish indoor units a BPMKS unit is needed



## High COP values

A major feature of VRV IV S-series is its exceptional energy efficiency. The system achieves high COPs during both cooling and heating operation by the use of refined components and functions.

- <sup>1</sup> Nominal cooling capacities are based on: indoor temperature: 27°CDB, 19°CWB, outdoor temperature: 35°C, equivalent refrigerant piping: 5m, level difference: 0m.
- <sup>2</sup> Nominal heating capacities are based on: indoor temperature: 20°CDB, outdoor temperature: 7°CDB, 6°CWB, equivalent refrigerant piping: 5m, level difference: 0m

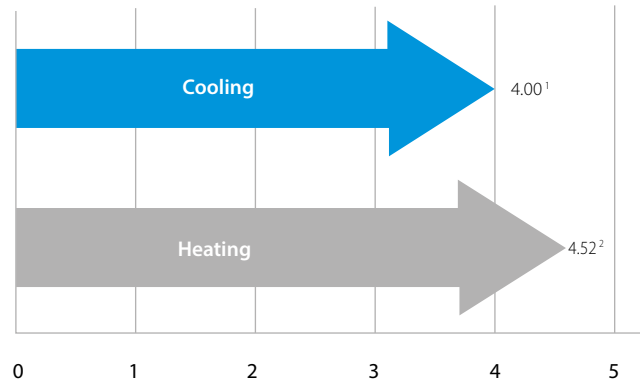

## Flexible piping design

	VRV indoors connected	Stylish indoors connected
Total piping length	300m	140m
Longest length actual	120m (4-8HP)/ 150m (10-12HP)	
Minimum length between outdoor unit and first branch	-	5m
Minimum piping length between BP and indoor unit	-	2m
Maximum piping length between BP and indoor unit	-	15m
Longest length after first branch	40m	40m
Level difference between indoor and outdoor units	50m (40m <sup>1</sup> )	30m
Level difference between indoor units	15m	15m

<sup>1</sup> Outdoor unit in lowest position

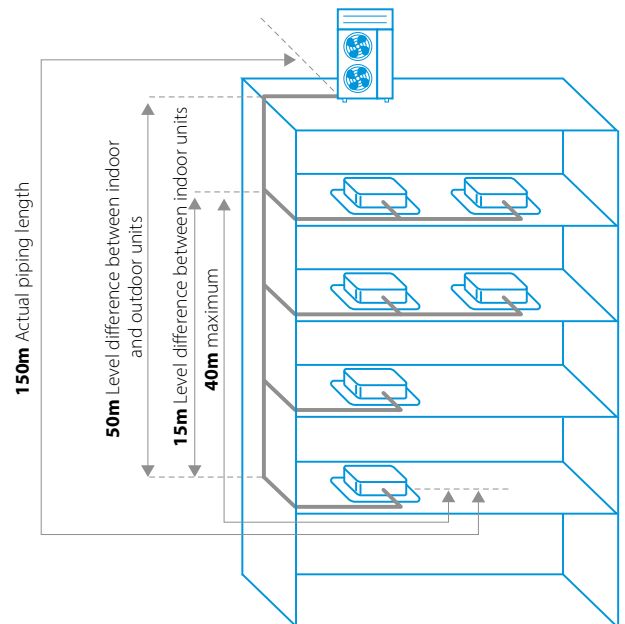

# VRV IV S-series

## technologies

### Super aero grille

The spiral shaped ribs are aligned with the direction of discharge flow in order to minimise turbulence and reduce noise.



### Refrigerant-cooled PCB

- > Reliable cooling because it is not influenced by ambient air temperature
- > Smaller switchbox for smoother air flow through the heat exchanger increasing heat exchange efficiency with 5%



### Improved fan blades

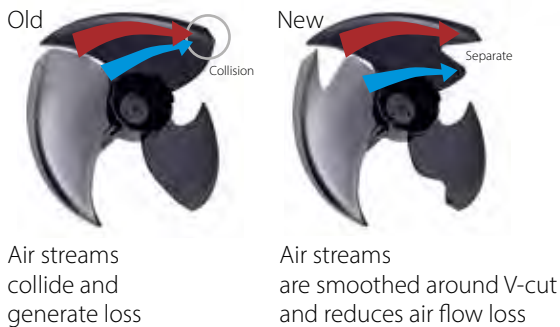

Vane fixed to rotor  
Rotor

### Compressor

Swing type > **no oil separator**  
Vane & rotor are unified resulting in:

- > Reduced noise level
- > Longer compressor life
- > Higher efficiency thanks to the absence of internal refrigerant leakage between high and low pressure side

### E-Pass heat exchanger

Optimising the heat exchanger's path layout prevents heat being transferred from the overheated gas section to the sub-cooled liquid section which is a more efficient way to use the heat exchanger.

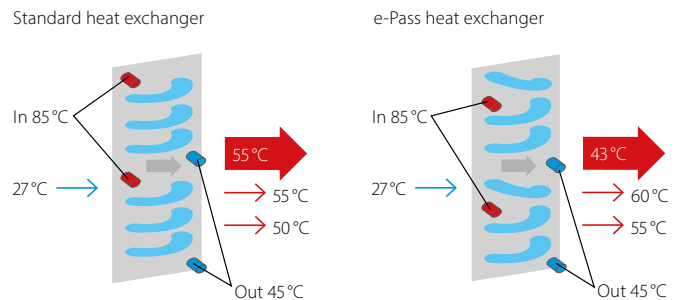

### I-demand function

Limit maximum power consumption. The newly introduced current sensor minimizes the difference between the actual power consumption and the predefined power consumption.

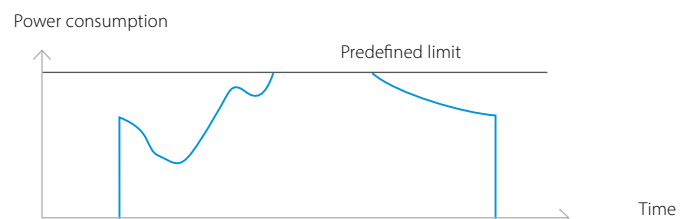

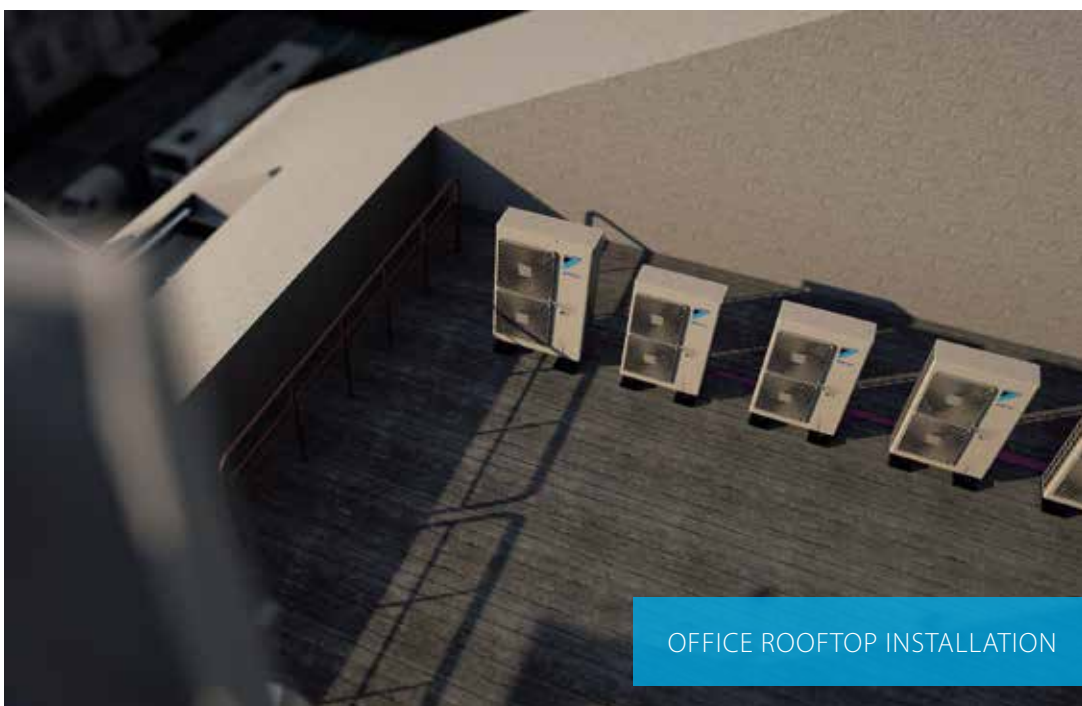

# VRV IV S-series compact heat pump

## The most compact VRV

- › Compact & lightweight single fan design makes the unit almost unnoticeable
- › Covers all thermal needs of a building via a single point of contact: accurate temperature control, ventilation, air handling units and Biddle air cutains
- › Wide range of indoor units: either connect VRV or stylish indoor units such as Daikin Emura, Nexura ...
- › Incorporates VRV IV standards & technologies: Variable Refrigerant Temperature and full inverter compressors
- › Possibility to limit peak power consumption between 30 and 80%, for example during periods with high power demand
- › Contains all standard VRV features



Only **823mm** high!



Already fully compliant

to LOT 21 - Tier 2

Published data with real-life indoor units

## Connectable stylish indoor units

		15 CLASS	20 CLASS	25 CLASS	35 CLASS	42 CLASS	50 CLASS	60 CLASS	71 CLASS
Round flow cassette	FCAG-B				•				•
Fully flat cassette	FFA-A9			•	•				•
Slim concealed ceiling unit	FDXM-F9			•	•				
Concealed ceiling unit with inverter driven fan	FBA-A(9)			•	•			•	
Daikin Emura - Wall mounted unit	FTXJ-MW/MS		•	•	•				
Wall mounted unit	CTXM-M	•			•				
Wall mounted unit	FTXM-N		•	•	•	•	•	•	•
Ceiling suspended unit	FHA-A(9)				•			•	
Nexura - Floor standing unit	FVXG-K			•	•		•		
Floor standing unit	FVXM-F			•	•		•		
Concealed floorstanding unit	FNA-A9			•	•		•	•	
Flexi type unit	FLXS-B(9)			•	•		•	•	



Access all technical information on RXYSCQ-TV1 at [my.daikin.eu](http://my.daikin.eu) or click here

Outdoor unit		RXYSCQ	4TV1	5TV1
Capacity range		HP	4	5
Cooling capacity	Prated,c	kW	12.1	14.0
Heating capacity	Prated,h	kW	8.4	9.7
	Max. 6°CWB	kW	14.2	16.0
Recommended combination			3 x FXSQ25A2VEB + 1 x FXSQ32A2VEB	4 x FXSQ32A2VEB
ηs,c		%	322.8	303.4
ηs,h		%	182.3	185.1
SEER			8.1	7.7
SCOP			4.6	4.7
Maximum number of connectable indoor units			64	
Indoor index connection	Min.		50.0	62.5
	Nom.			-
	Max.		130.0	162.5
Dimensions	Unit	HeightxWidthxDpeth	mm	
			823x940x460	
Weight	Unit		kg	
			94	
Sound power level	Cooling	Nom.	dBA	69.0
			68.0	
Sound pressure level	Cooling	Nom.	dBA	52.0
			51.0	
Operation range	Cooling	Min.~Max.	°CDB	
			-5.0~46.0	
Refrigerant	Heating	Min.~Max.	°CWB	
			-20.0~15.5	
Refrigerant	Type/GWP		R-410A/2,087.5	
	Charge	kg/TCO2Eq	3.7/7.7	
Piping connections	Liquid	OD	mm	
			952	
	Gas	OD	mm	
			15.9	
	Total piping length	System Actual	m	
			300	
Power supply	Phase/Frequency/Voltage		Hz/V	
			1~/50/220-240	
Current - 50Hz	Maximum fuse amps (MFA)	A	32	

(1) Actual number of units depends on the indoor unit type (VRV DX indoor, RA DX indoor, etc.) and the connection ratio restriction for the system (being: 50% ≤ CR ≤ 130%).



# VRV IV S-series heat pump

Space saving solution without compromising on efficiency

- › Space saving trunk design for flexible installation
- › Covers all thermal needs of a building via a single point of contact: accurate temperature control, ventilation, air handling units and Biddle air cutains
- › Wide range of indoor units: either connect VRV or stylish indoor units such as Daikin Emura, Nexura ...
- › Wide range of units (4 to 12HP) suitable for projects up to 200m<sup>2</sup> with space limitations
- › Incorporates VRV IV standards & technologies: Variable Refrigerant Temperature and full inverter compressors
- › Possibility to limit peak power consumption between 30 and 80%, for example during periods with high power demand
- › Contains all standard VRV features



RXYSQ4-6T8V\_T8Y



Already fully compliant to LOT 21 - Tier 2

Published data with real-life indoor units

## Connectable stylish indoor units

		15 CLASS	20 CLASS	25 CLASS	35 CLASS	42 CLASS	50 CLASS	60 CLASS	71 CLASS
Round flow cassette	FCAG-B				•		•	•	•
Fully flat cassette	FFA-A9			•	•		•	•	
Slim concealed ceiling unit	FDXM-F9			•	•		•	•	
Concealed ceiling unit with inverter driven fan	FBA-A(9)			•	•		•	•	
Daikin Emura - Wall mounted unit	FTXJ-MW/MS		•	•	•		•		
Wall mounted unit	CTXM-M	•			•				
Wall mounted unit	FTXM-N		•	•	•	•	•	•	•
Ceiling suspended unit	FHA-A(9)				•		•	•	
Nexura - Floor standing unit	FVXG-K			•	•		•		
Floor standing unit	FVXM-F			•	•		•		
Concealed floorstanding unit	FNA-A9			•	•		•	•	
Flexi type unit	FLXS-B(9)			•	•		•	•	



Access all technical information on RXYSQ-T8V at my.daikin.eu or click here



Access all technical information on RXYSQ-T8Y at my.daikin.eu or click here



Access all technical information on RXYSQ-TY1 at my.daikin.eu or click here

Outdoor unit		RXYSQ/RXYSQ/RXYSQ	4T8V	5T8V	6T8V	4T8Y	5T8Y	6T8Y	8TY1	10TY1	12TY1	
Capacity range		HP	4	5	6	4	5	6	8	10	12	
Cooling capacity	Prated,c	kW	12.10	14.00	15.50	12.10	14.00	15.50	22.4	28.0	33.5	
Heating capacity	Prated,h	kW	8.00	9.20	10.20	8.00	9.20	10.20	14.9	19.6	23.5	
	Max. 6°CWB	kW	14.2	16.0	18.0	14.2	16.0	18.0	25.0	31.5	37.5	
Recommended combination			3 x FXSQ25A2VEB + 1 x FXSQ32A2VEB	4 x FXSQ32A2VEB	2 x FXSQ32A2VEB + 2 x FXSQ40A2VEB	3 x FXSQ25A2VEB + 1 x FXSQ32A2VEB	4 x FXSQ32A2VEB	2 x FXSQ32A2VEB + 2 x FXSQ40A2VEB	4 x FXMQ50P7VEB	4 x FXMQ63P7VEB	6 x FXMQ50P7VEB	
ηs,c		%	278.9	270.1	278.0	269.2	260.5	268.3	247.3	247.4	256.5	
ηs,h		%	171.6	182.9	192.8	154.4	164.5	174.1	165.8	162.4	169.6	
SEER			7.0	6.8	7.0	6.8	6.6	6.8	6.3		6.5	
SCOP			4.4	4.6	4.9	3.9	4.2	4.4	4.2	4.1	4.3	
Maximum number of connectable indoor units			64									
Indoor index connection	Min.		50.0	62.5	70.0	50.0	62.5	70.0	100.0	125.0	150.0	
	Nom.											
	Max.		130.0	162.5	182.0	130.0	162.5	182.0	260.0	325.0	390.0	
Dimensions	Unit	HeightxWidthxDepth	mm						mm		mm	
	Unit		1,345x900x320									
Weight			kg									
			104									
Sound power level	Cooling	Nom.	dBA	68.0	69.0	70.0	68.0	69.0	70.0	73.0	74.0	76.0
Sound pressure level	Cooling	Nom.	dBA	50.0	51.0		50.0	51.0		55.0		57.0
Operation range	Cooling	Min.-Max.	°CDB	-5.0~46.0						-5.0~52.0		
	Heating	Min.-Max.	°CWB	-20.0~15.5								
Refrigerant	Type/GWP		R-410A/2,087.5									
	Charge	kg/TCO2Eq	3.6/7.5						5.5/11.5	7.0/14.6	8.0/16.7	
Piping connections	Liquid	OD	mm									
	Gas	OD	15.9		19.1		15.9		19.1		22.2	
	Total piping length	System Actual	m									
			300									
Power supply	Phase/Frequency/Voltage	Hz/V	1N~/50/220-240				3N~/50/380-415					
Current - 50Hz	Maximum fuse amps (MFA)	A	32				16		25		32	

(1) Actual number of units depends on the indoor unit type (VRV DX indoor, RA DX indoor, etc.) and the connection ratio restriction for the system (being: 50% ≤ CR ≤ 130%).

# VRV IV i-series heat pump for indoor installation

unique  
patented  
concept

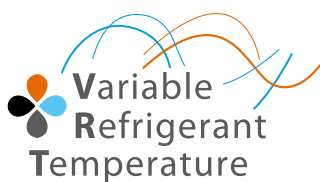
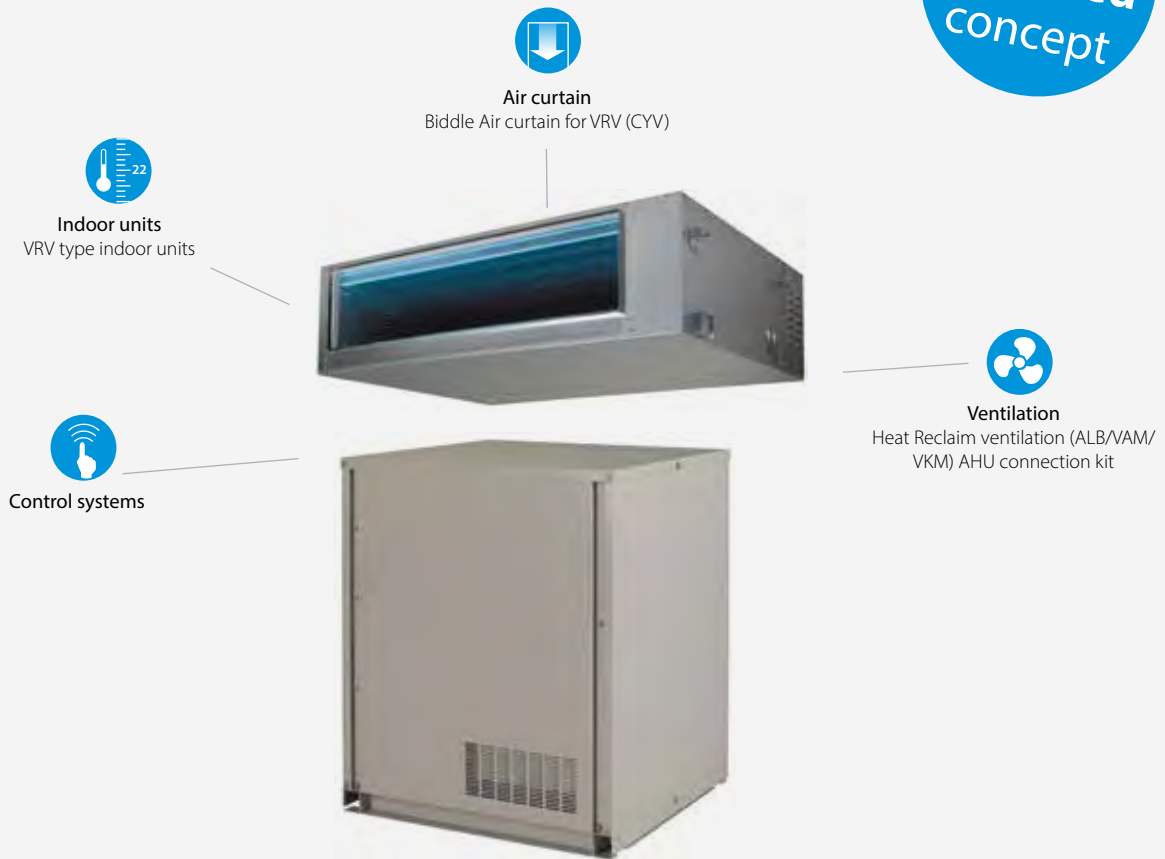

## VRV IV standards:

### Variable refrigerant temperature

Customize your VRV for best seasonal efficiency & comfort

### VRV configurator

Software for simplified commissioning, configuration and customisation

- › Night quiet mode
- › Full inverter compressors
- › Low noise function
- › Sine wave DC inverter
- › DC fan motor
- › E-pass heat exchanger
- › I demand function
- › Manual demand function

For detailed explanation of these functions refer to vrv iv technologies tab



# Invisible

- > Consider a wider range of properties because outdoor installation is not a factor
- > Open for business sooner because getting building permits is simplified
- > Seamless integration into the surroundings as only the grille is visible
- > No need for a roof installation or back alley installation



# Quiet

- > Highly suited to densely populated areas such as city centres thanks to their low operating sound
- > Dedicated modes reduce sound further to comply with inner-city noise regulations

Heat exchanger sound not louder than a normal conversation

Compressor sound not louder than a refrigerator

Lightweight parts can be installed by two people

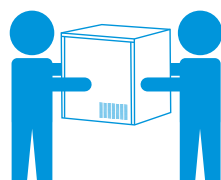

# Unique split outdoor unit for indoor installation

Compact and easy to hide, the compressor can be installed at floor level, in a back office, storage room, technical area or in a kitchen, while the

heat exchanger can be installed in a false ceiling space. This means that the air conditioning system is completely invisible and does not take up expensive commercial floor space.

## Unrivalled flexibility thanks to the fact that the outdoor unit is split into two parts

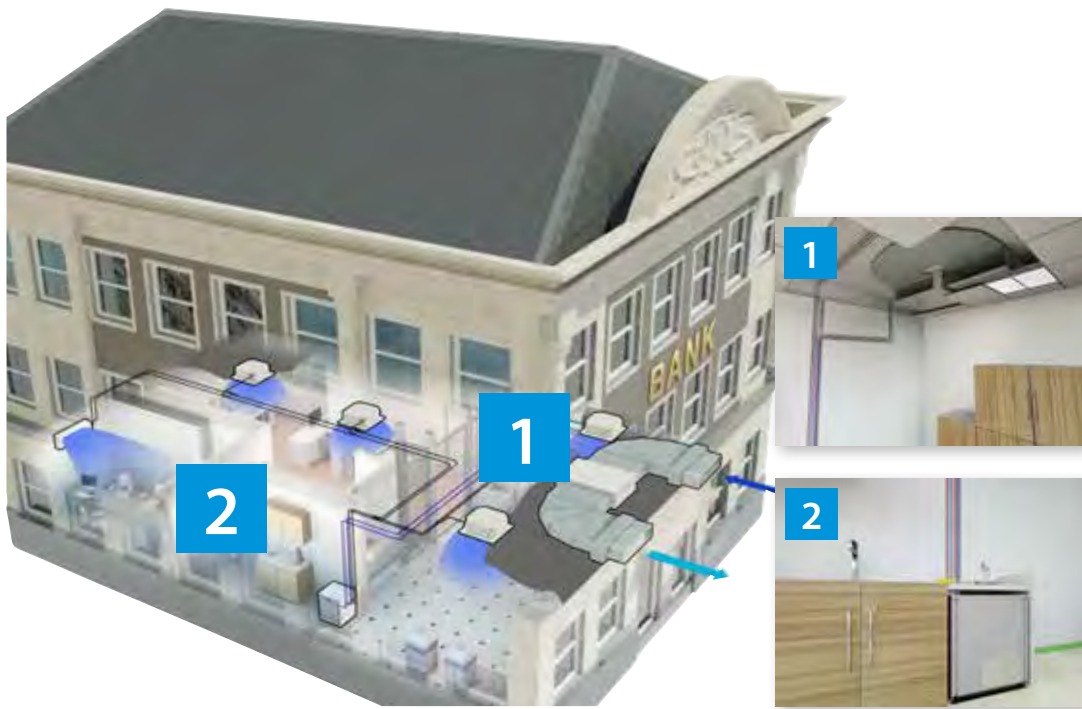

**1.** The heat exchanger can be installed in a false ceiling space.

**2.** The compressor is compact and easy to hide, this element can be installed at floor level, in a back office, storage room, technical area or in a kitchen.

**This means that the air conditioning system is completely invisible and does not take up expensive commercial floor space.**

VRV Indoor units

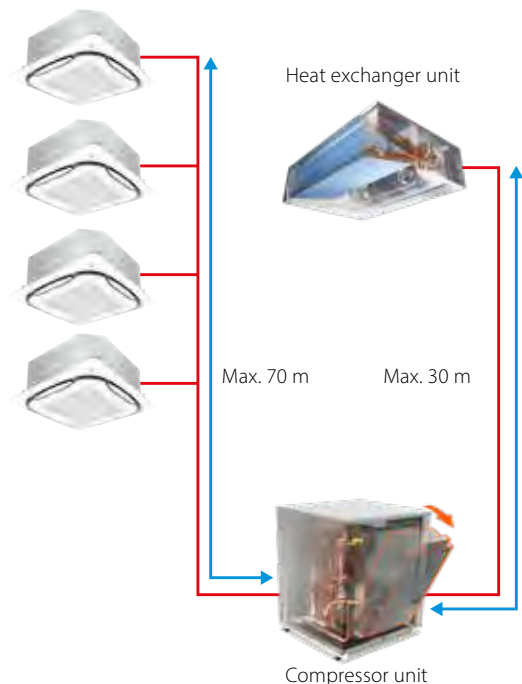

Max. total piping length: 140m (5HP) / 300m (8HP)

# Invisible air suction and air discharge

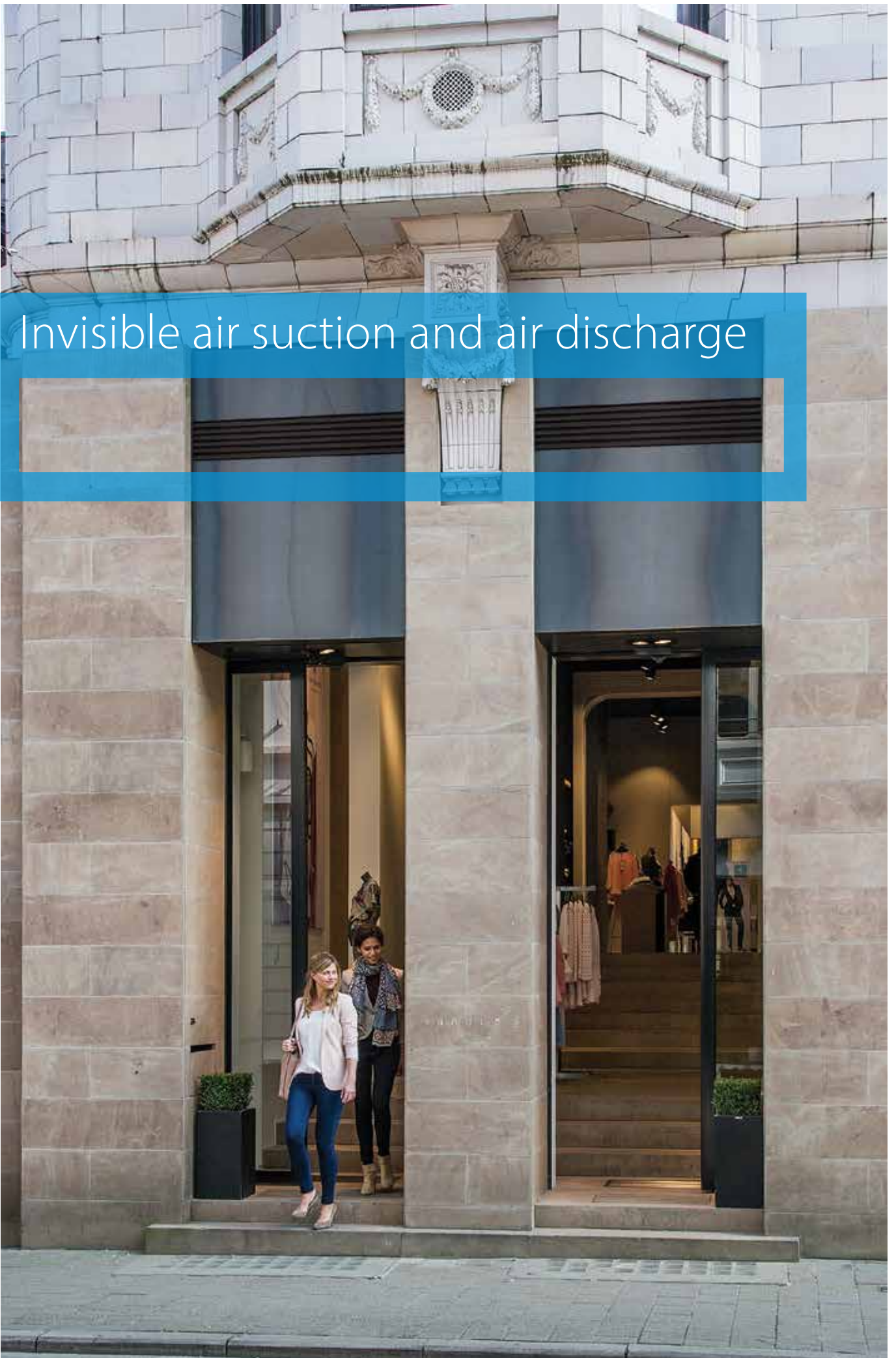

# The problem solver

## for many installation issues

### Example 1

### High flexibility

**The other way around: install the modules where it fits your customer, not where it is the best fit for the outdoor unit**

If there is no flat roof or backgarden available for installation of the outdoor unit, VRV IV i-series offers the solution.

The suction and exhaust can be installed at the façade or at the rear of the building as the inverter fans allows ESP to be adjusted to the length of the ductwork.

The compressor module can be installed up to 30 m from the heat exchanger unit in a storage room, ....

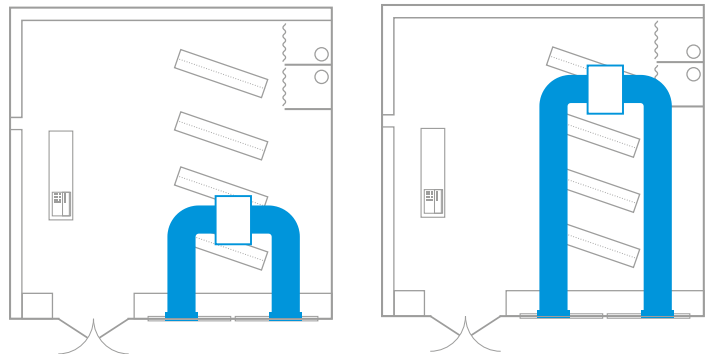

Flexible installation thanks to inverter fans



### Example 2

## Shorter pipe runs to the indoor units reduces installation costs compared to rooftop or back alley installation

#### Back alley or rooftop needs very long piping lengths

- > Long installation time
- > Additional cost
- > Capacity loss

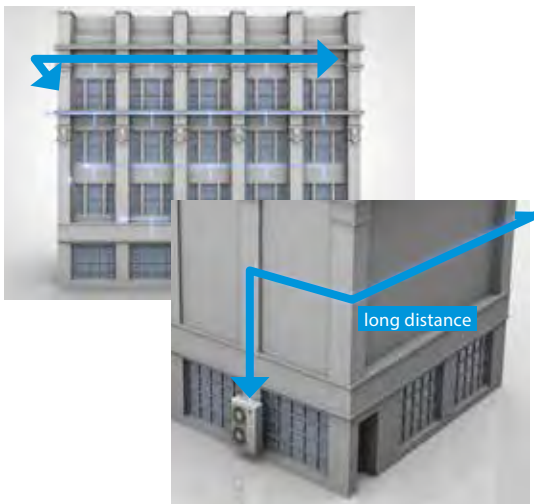

#### VRV IV i-series can be installed close to the indoor units

- > Quicker installation
- > Lower cost
- > No capacity loss

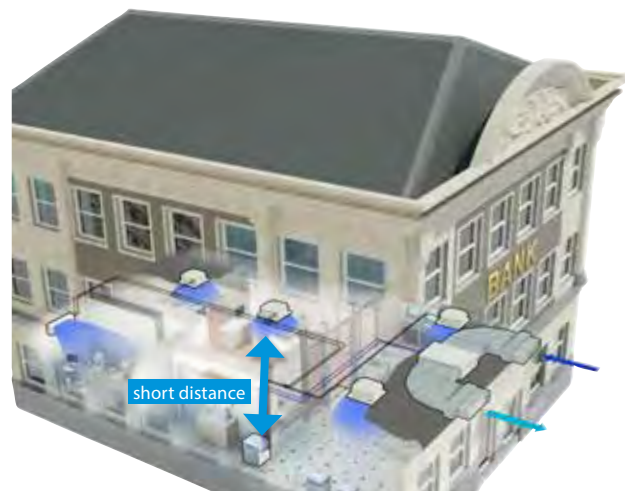

### Example 3

## No need for bulky and expensive sound countermeasures

#### To comply with city regulation countermeasures are needed for standard units

- > Expensive sound cages might be needed to reduce sound (standard outdoor unit sound = 50~60 dBA)
- > Inside installation using expensive floor space

#### With VRV IV i-series you easily comply with city regulation without additional measures

- > Operation sound 47 dBA for 5HP model (flexible to install in corridor, shop area, ...) or lower with attenuator
- > No floor space is used as units can be installed in false ceiling, against the wall, ...

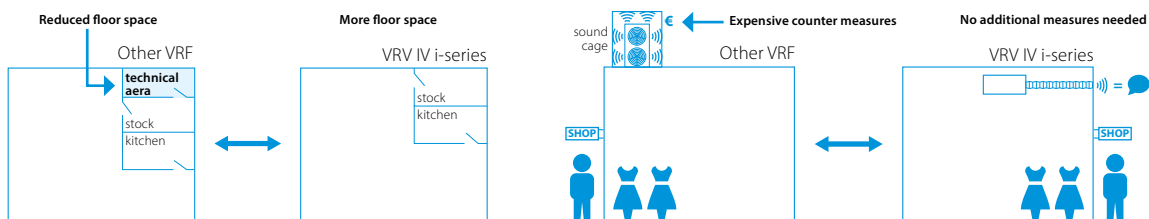

# Patented V-shape heat exchanger for best surface to volume ratio

8  
patents

## Optimised air flow and temperature distribution

› Best performance for defrost (tested in high humidity down to -20°C).

## Patented perforated and insulated partition plate

Reduces conductivity and prevents cold bridges



Only  
400mm  
high

Fits easily in  
any false ceiling

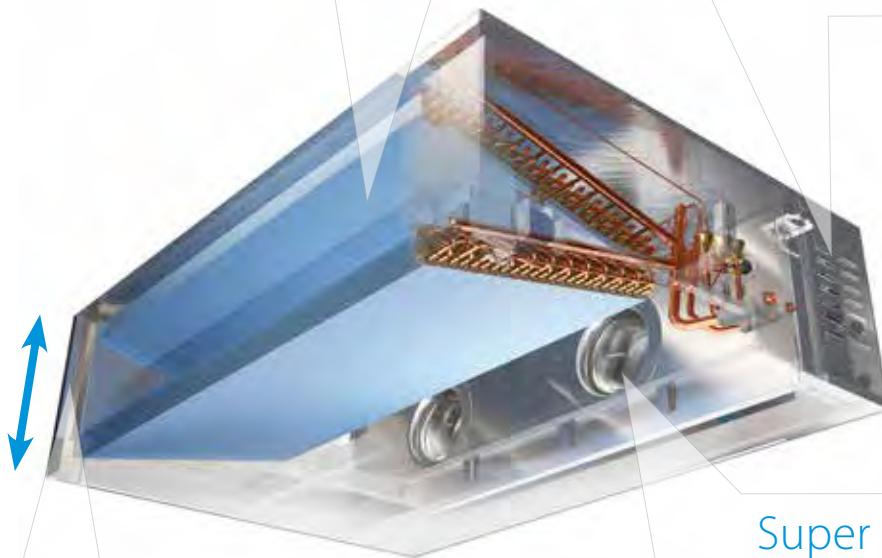

## Standard delivered filter

› with the unit to prevent dirt from entering the heat exchanger



## Super efficient centrifugal fans

› Over 50% efficiency increase compared to sirocco fan  
› Patented backward-curved blade technology  
› More pressure increase



# Compressor unit with rotating switchbox

Flexible and easy to install

Flexibility by back and top refrigerant connection possibility

Rotating switchbox

- › For easy access to all compressor parts

Only  
**77 kg**  
(5HP)

Tube-in-tube subcool heat exchanger

- › This patented heat exchanger increases the capacity of the system by ensuring optimal state of refrigerant in the heat exchanger module. This in turn increases overall efficiency.

No drain connection needed

- › Thanks to natural evaporation
- › Minimized cold surface to reduce dew formation
- › Fast and easy installation

Non welded bottom casing

- › Avoids any corrosion risk

Small footprint

- › Maximizes useable floor space (600 x 554 mm for 5HP)
- › Can easily be mounted in a storage room, back office, ...

# VRV IV heat pump for indoor installation

## The invisible VRV

› Unique VRV heat pump for indoor installation



› Unrivalled flexibility because the unit is split up into two elements: the heat exchanger and the compressor

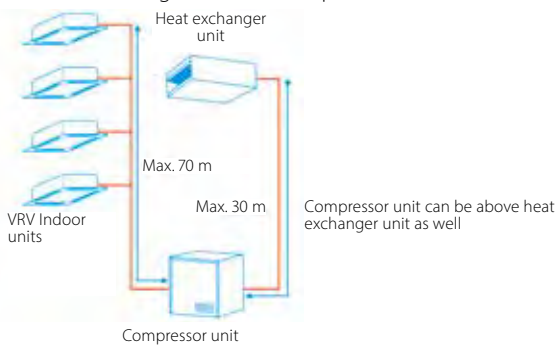

- › Highly suited to densely populated areas thanks to the low operation sound and seamless integration into surrounding architecture as only the grille is visible
- › Incorporates VRV IV standards & technologies: Variable Refrigerant Temperature, VRV configurator and full inverter compressors



- › Covers all thermal needs of a building via a single point of contact: accurate temperature control, ventilation, air handling units and Biddle air curtains
- › Lightweight units (max. 105kg) can be installed by two people
- › Unique V-shape heat exchanger results in compact dimensions (h/e unit only 400mm high) allowing false ceiling installation, while ensuring top efficiency
- › Super efficient centrifugal fans (over 50% efficiency increase compared to sirocco fan)
- › Small footprint compressor unit (760 x 554 mm) maximizing useable floor space
- › Contains all standard VRV features



Already fully compliant to LOT 21 - Tier 2

Published data with real-life indoor units

Access all technical information on SB-RKXYQ-T at [my.daikin.eu](http://my.daikin.eu) or click here

Access all technical information on SB-RKXYQ-T(8) at [my.daikin.eu](http://my.daikin.eu) or click here

System				SB.RKXYQ	5T8	8T	
System	Heat exchanger unit				RDXYQ5T8	RDXYQ8T	
	Compressor unit				RKXYQ5T8	RKXYQ8T	
Capacity range				HP	5	8	
Cooling capacity	Prated,c			kW	14.0	22.4	
Heating capacity	Prated,h			kW	10.4	12.9	
	Max.	6°CWB		kW	16.0	25.0	
Recommended combination					4 x FXSQ32A2VEB	4 x FXMQ50P7VEB	
ηs,c				%	200.1	191.1	
ηs,h				%	149.3	140.9	
SEER					5.1	4.9	
SCOP					3.8	3.6	
Maximum number of connectable indoor units					10	17	
Indoor index connection	Min.				62.5	100.0	
	Nom.				-	-	
	Max.				162.5	260.0	
Piping connections	Liquid	OD	mm		-	-	
	Gas	OD	mm		-	-	
	Between Compressor module (CM) and heat exchanger module (HM)	Liquid	OD	mm		12.7	
		Gas	OD	mm		19.1	22.2
	Between Compressor module (CM) and indoor units (IU)	Liquid	OD	mm		9.52	
		Gas	OD	mm		15.9	19.1
Total piping length	System	Actual	m		140	300	
					<b>Heat exchanger module - RDXYQ</b>		
					<b>5T8</b>	<b>8T</b>	
					<b>Compressor module - RKXYQ</b>		
					<b>5T8</b>	<b>8T</b>	
Outdoor unit module	Unit	HeightxWidthxDepth	mm		397x1,456x1,044	701x600x554	
	Unit		kg		95	103	
Fan	Air flow rate	Cooling	Nom.	m <sup>3</sup> /min	55	100	
Sound power level	Cooling	Nom.		dB(A)	77.0	81	
Sound pressure level	Cooling	Nom.		dB(A)	47.0	54	
Refrigerant	Type/GWP				R-410A/-	R-410A/2,087.5	
	Charge		kg/CO <sub>2</sub> eq		-/-	2.00/4.20	
Power supply	Phase/Frequency/Voltage			Hz/V	1N~/50/220-240	3N~/50/380-415	
Current - 50Hz	Maximum fuse amps (MFA)			A	10	16	
						20	

(1) Actual number of units depends on the indoor unit type (VRV DX indoor, RA DX indoor, etc.) and the connection ratio restriction for the system (being; 50% ≤ CR ≤ 130%).



# VRV IV C<sup>+</sup> series

Where heating is priority without compromising on efficiency

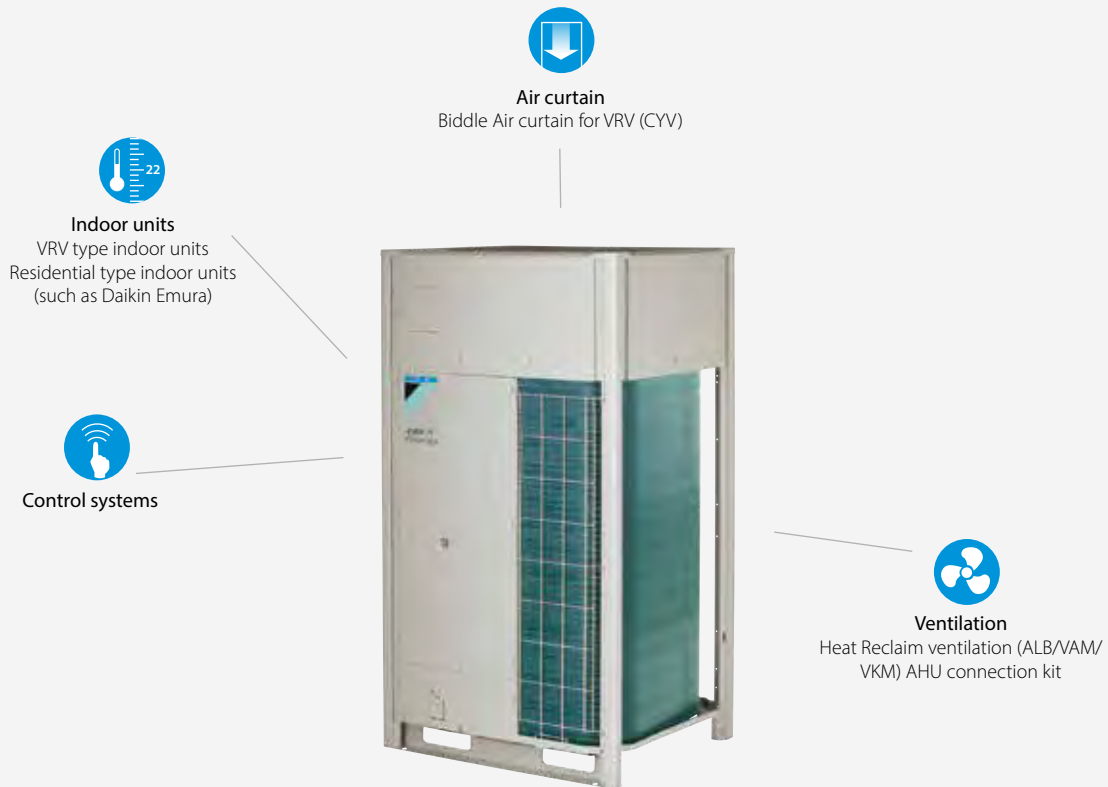

Outdoor Units

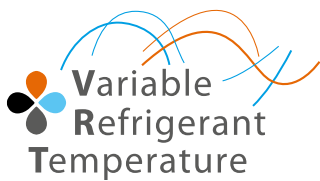

## VRV IV standards:

### Variable refrigerant temperature

Customize your VRV for best seasonal efficiency & comfort

### VRV configurator

Software for simplified commissioning, configuration and customisation

- > 7 segment display
- > Automatic refrigerant charge
- > Refrigerant containment check
- > Night quiet mode
- > Low noise function
- > Connectable to stylish indoor units (Only for single modules)
- > Full inverter compressors
- > Gas cooled PCB
- > 4 side heat exchanger
- > Reluctance brushless DC compressor
- > Sine wave DC inverter
- > DC fan motor
- > E-pass heat exchanger
- > I demand function
- > Manual demand function



VRV IV+ heat pump, optimised for cold climates

## RXYLQ-T



Where heating is priority without compromising on efficiency



### High heating capacity at low ambient temperatures

› Stable heating capacity available down to -15°C WB!

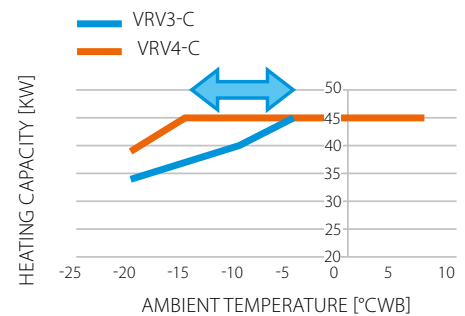

### High partial load efficiency

- › New vapour injection scroll compressor optimised for low load
- UNIQUE back-pressure control: Pressure port increases pressure below the scroll in low load operation, preventing refrigerant leak and increasing efficiency
- UNIQUE Injection structure with check valve: Prevents volume backflow during low load operation typically occurring with standard vapour injection compressors
- › Variable Refrigerant Temperature adjusts refrigerant temperature to match the load



### High reliability down to -25°C WB

› Hot gas bypass prevents ice buildup at the bottom of the heat exchanger





Already fully compliant to LOT 21 - Tier 2

### High seasonal efficiency

- > **Measured with indoor units for real applications!**
- > ALL information for indoor units used available on our eco-design website: [Already fully compliant https://energylabel.daikin.eu/eu/en\\_US/lot21.html](https://energylabel.daikin.eu/eu/en_US/lot21.html)

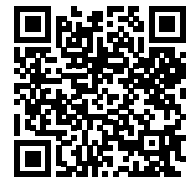

### The known VRV IV standards

- Variable Refrigerant Temperature
- VRV configurator

### Total solution



Daikin Emura  
Wall mounted unit



Nexura  
Floor standing unit

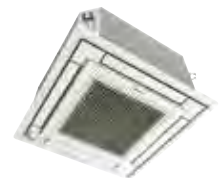

Fully flat cassette



Biddle air curtain



Air handling unit for ventilation



Low temperature hydrobox

# VRV heat pump optimised for heating

## Where heating is priority without compromising on efficiency

- Specifically developed for heating operation in low ambient conditions, making it suitable for single source heating
- Stable heating capacity down to -15°C, thanks to vapour injection compressor
- Extended operation range down to -25°C in heating
- High reliability in severe conditions, thanks to hot gas bypass circuit in the heat exchanger
- 15% increased heating capacity at high relative humidity (2°CDB/1°CWB and RH=83%) vs previous model
- Shorter defrost and heat up time, compared to standard VRV heat pump
- Covers all thermal needs of a building via a single point of contact: accurate temperature control, ventilation, air handling units and Biddle air curtains

- Wide range of indoor units: possibility to combine VRV with stylish indoor units (Daikin Emura, Nexura, ...)
- Incorporates VRV IV standards & technologies: Variable Refrigerant Temperature, VRV configurator, 7 segment display and full inverter compressors, 4-side heat exchanger, refrigerant cooled PCB, new DC fan motor, ...
- Free combination of outdoor units to meet installation space or efficiency requirements
- Wide piping flexibility: 30m indoor height difference, maximum piping length: 190m, total piping length: 500m
- Less installation time and smaller footprint compared to previous model thanks to removal of function unit



Already fully compliant to LOT 21 - Tier 2

Published data with real-life indoor units



Access all technical information on RXYLQ-T at [my.daikin.eu](http://my.daikin.eu) or click here

Outdoor unit		RXYLQ	10T	12T	14T
Capacity range		HP	10	12	14
Cooling capacity	Prated,c	kW	28	33.5	40
Heating capacity	Prated,h	kW	31.5	37.5	45
	Max. 6°CWB	kW	31.50	37.50	45.00
Recommended combination			4 x FXMQ63P7VEB	6 x FXMQ50P7VEB	1 x FXMQ50P7VEB + 5 x FXMQ63P7VEB
ηs,c		%	251.4	274.4	270.1
ηs,h		%	144.3	137.6	137.1
SEER			6.36	6.93	6.83
SCOP			3.68	3.51	3.5
Maximum number of connectable indoor units				64 (1)	
Indoor index connection	Min.		175	210	245
	Nom.		250	300	350
	Max.		325	390	455
Dimensions	Unit	HeightxWidthxDepth	mm		
Weight	Unit		kg		
Sound power level	Cooling	Nom.	77	81	81
Sound pressure level	Cooling	Nom.	56	59	59
Operation range	Cooling	Min.-Max.	°CDB		
	Heating	Min.-Max.	°CWB		
Refrigerant	Type/GWP		R-410A/2,087.5		
	Charge	kg/TCO2Eq	11.8/24.6		
Piping connections	Liquid	OD	9.5		12.7
	Gas	OD	22.2		28.6
	Total piping length	System Actual	m		
Power supply	Phase/Frequency/Voltage	Hz/V	3N~/50/380-415		
Current - 50Hz	Maximum fuse amps (MFA)	A	25		32

Outdoor unit		RXYLQ	16T	18T	20T	22T	24T	26T	28T
System	Outdoor unit module 1		RXMLQ8T	RXYLQ10T	RXYLQ10T	RXYLQ10T	RXYLQ12T	RXYLQ12T	RXYLQ14T
	Outdoor unit module 2		RXMLQ8T	RXMLQ8T	RXYLQ10T	RXYLQ12T	RXYLQ12T	RXYLQ14T	RXYLQ14T
Capacity range		HP	16	18	20	22	24	26	28
Cooling capacity	Prated,c	kW	44.8	50.4	56	61.5	67	73.5	80
Heating capacity	Prated,h	kW							
	Max. 6°CWB	kW	50	56.5	63	69	75	82.5	90
Recommended combination			4 x FXMQ63P7VEB + 2 x FXMQ80P7VEB	3 x FXMQ50P7VEB + 5 x FXMQ63P7VEB	2 x FXMQ50P7VEB + 6 x FXMQ63P7VEB	6 x FXMQ50P7VEB + 4 x FXMQ63P7VEB	4 x FXMQ50P7VEB + 4 x FXMQ63P7VEB + 2 x FXMQ80P7VEB	7 x FXMQ50P7VEB + 5 x FXMQ63P7VEB	6 x FXMQ50P7VEB + 4 x FXMQ63P7VEB + 2 x FXMQ80P7VEB
ηs,c		%							
ηs,h		%							
SEER									
SCOP									
Maximum number of connectable indoor units			64 (1)						
Indoor index connection	Min.		280	315	350	385	420	455	490
	Nom.		400	450	500	550	600	650	700
	Max.		520	585	650	715	780	845	910
Piping connections	Liquid	OD	mm	12.7	15.9	15.9	15.9	15.9	19.1
	Gas	OD	mm	28.6	28.6	28.6	28.6		34.9
	Total piping length	System Actual	m	500					
Power supply	Phase/Frequency/Voltage	Hz/V	3N~/50/380-415						
Current - 50Hz	Maximum fuse amps (MFA)	A	40	45	50			60	

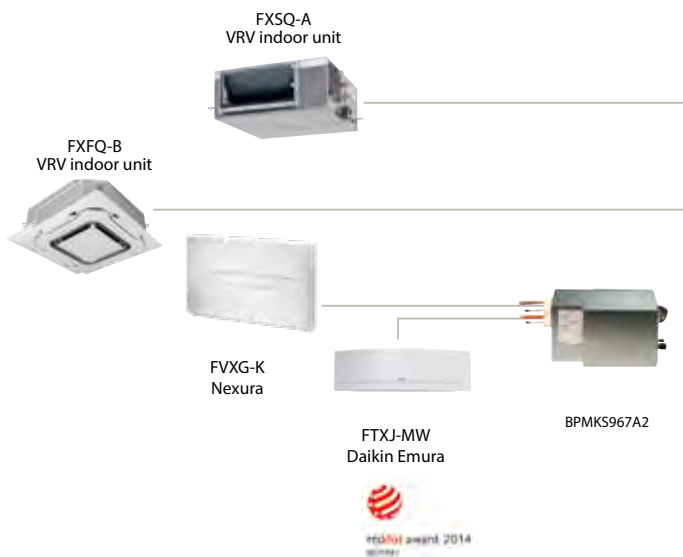

RXYLQ-T

Connectable stylish indoor units

		15 CLASS	20 CLASS	25 CLASS	35 CLASS	42 CLASS	50 CLASS	60 CLASS	71 CLASS
Daikin Emura - Wall mounted unit	FTXJ-MW/MS		•	•	•		•		
Wall mounted unit	CTXM-M	•							
Wall mounted unit	FTXM-N		•	•	•	•	•	•	•
Nexura - Floor standing unit	FVXG-K			•	•		•		
Floor standing unit	FVXM-F			•	•		•		
Flexi type unit	FLXS-B(9)			•	•		•	•	

BPMKS box needed to connect RA indoors to VRV IV (RYYQ / RXYQ)

Outdoor unit		RXYLQ	30T	32T	34T	36T	38T	40T	42T
System	Outdoor unit module 1	RXYLQ10T							
	Outdoor unit module 2	RXYLQ10T							
	Outdoor unit module 3			RXYLQ12T			RXYLQ14T		
Capacity range	HP	30	32	34	36	38	40	42	
Cooling capacity	Prated,c kW	84	89,5	95	101	107	114	120	
Heating capacity	Prated,h kW				-				
	Max. 6°CWB kW	94,5	100,5	106,5	112,5	120	127,5	135	
Recommended combination		9 x FXMQ50P7VEB + 5 x FXMQ63P7VEB	8 x FXMQ63P7VEB + 4 x FXMQ80P7VEB	3 x FXMQ50P7VEB + 9 x FXMQ63P7VEB + 2 x FXMQ80P7VEB	2 x FXMQ50P7VEB + 10 x FXMQ63P7VEB + 2 x FXMQ80P7VEB	6 x FXMQ50P7VEB + 10 x FXMQ63P7VEB	9 x FXMQ50P7VEB + 9 x FXMQ63P7VEB	12 x FXMQ63P7VEB + 4 x FXMQ80P7VEB	
η <sub>s,c</sub>	%				-				
η <sub>s,h</sub>	%				-				
SEER					-				
SCOP					-				
Maximum number of connectable indoor units					64 (1)				
Indoor index connection	Min.		525	560	595	630	665	700	735
	Nom.		750	800	850	900	950	1000	1050
	Max.		975	1040	1105	1170	1235	1300	1365
Piping connections	Liquid OD	mm	19,1	19,1	19,1	19,1	19,1	19,1	19,1
	Gas OD	mm	34,9	34,9	34,9	41,3		41,3	
	Total piping length	System Actual m				500			
Power supply	Phase/Frequency/Voltage	Hz/V				3N~/50/380-415			
Current - 50Hz	Maximum fuse amps (MFA)	A			80		90		
Outdoor unit		RXMLQ	8T						
Dimensions	Unit HeightxWidthxDepth	mm	1,685x1,240x765						
Weight	Unit	kg	302						
Sound power level	Cooling Nom.	dBA	75,0						
Sound pressure level	Cooling Nom.	dBA	55,0						
Operation range	Cooling Min.-Max.	°CDB	-5,0~43,0						
	Heating Min.-Max.	°CWB	-25,0~16,0						
Refrigerant	Type/GWP		R-410A/2,087,5						
	Charge	kg/CO <sub>2</sub> Eq	11,8/24,6						
Piping connections	Liquid OD	mm	9,5						
	Gas OD	mm	19,1						
	Total piping length	System Actual m	500						
Power supply	Phase/Frequency/Voltage	Hz/V	3N~/50/380-415						
Current - 50Hz	Maximum fuse amps (MFA)	A	20						

(1) Actual number of connectable indoor units depends on the indoor unit type and the connection ratio restriction for the system



The Post, 5-star hotel,  
VRV IV

# Replacement VRV

Quick & quality replacement for R-22 and R-407C systems

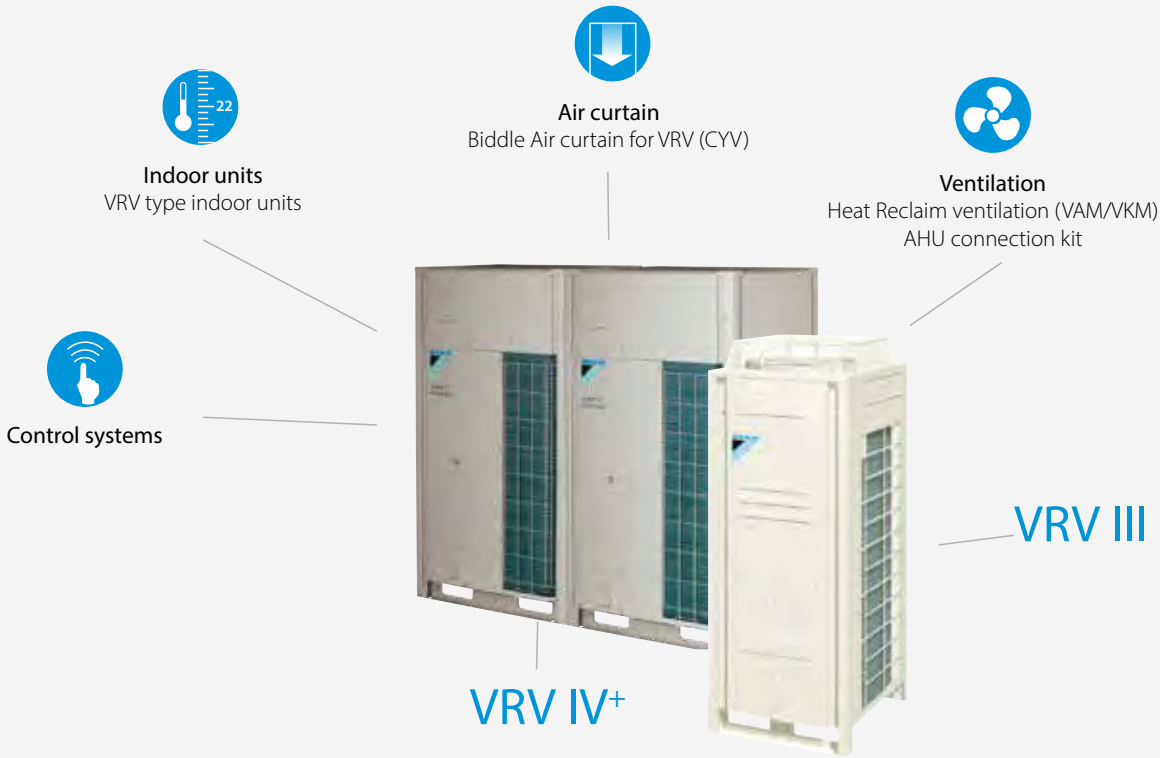

Outdoor Units

## VRV IV Q<sup>+</sup> series

Heat pump

Variable refrigerant temperature

Customize your VRV for best seasonal efficiency & comfort



VRV configurator

Software for simplified commissioning, configuration and customisation

- › 7 segment display
- › Automatic refrigerant charge
- › Night quiet mode
- › Low noise function
- › Full inverter compressors
- › Gas cooled PCB
- › 4 side heat exchanger
- › Reluctance brushless DC compressor
- › Sine wave DC inverter
- › DC fan motor
- › E-pass heat exchanger
- › I demand function
- › Manual demand function

## VRV III-Q

Heat pump & Heat recovery

- › Automatic refrigerant charge
- › Night quiet mode
- › Low noise function
- › Full inverter compressors
- › Reluctance brushless DC compressor
- › Sine wave DC inverter
- › DC fan motor
- › E-pass heat exchanger
- › I demand function
- › Manual demand function

For more information on these features refer to the VRV IV technologies tab

# Replacement technology



The quick and quality way of upgrading R-22 and R-407C systems

These benefits will convince your customer

Drastically improve your efficiency, comfort and reliability

### Avoid loss of business

Replacing now prevents unplanned, lengthy downtime of air conditioning systems. It also avoids loss of business for shops, complaints from guests in hotels, lower working efficiency and loss of tenants in offices.

### Quick and easy installation

No interruption of daily business while replacing the system thanks to phased-in, fast installation.

### Smaller footprint, more performance

Thanks to a smaller footprint, Daikin outdoor units save space. Also, more indoor units can be connected to the new outdoor unit compared to the old system, allowing to increase capacity.

### Lower long-term costs

EU Directives prohibit system repairs with R-22 after January 1, 2015. Delaying the required R-22 replacement until an unplanned system breakdown is a losing game. Replacement day will come. Installing a technically advanced system lowers energy consumption and maintenance costs from day one.

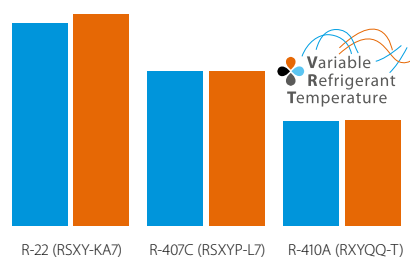

Up to 48% less consumption

Comparison of 10HP systems:  
 ■ Cooling mode  
 ■ Heating mode

## Keep your refrigerant piping

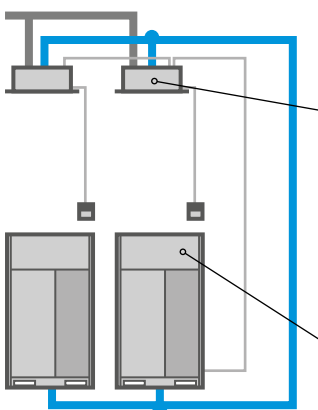

### The Daikin low-cost upgrade solution

**!** Replace indoor units and BS boxes

Contact your local dealer to check compatibility in case you need to keep the indoor units.

**!** Replace outdoor units

### Your copper pipes will last for multiple generations

- > copper pipes used in air conditioning systems tested by Daikin will last over 60 years after installation.
- > Japan/China have replaced with VRV Q-series already 10 years ago!

### Umeda Center Building, Japan

- > original A/C system: 20 years in use
- > replacement with VRV Q-series: 2006 - 2009
- > capacity up from 1620HP to 2322HP
- > SHASE renewal award:







**!** Planning your replacement in future?

**Monitor your system now!**

Your building use might have changed over the years. Monitoring and Daikin expert advice prepare you for an optimum replacement to maximize efficiency and comfort, while minimizing the investment cost of your new system.

## VRV-Q benefits to increase your profit

### Optimise your business

**Less installation time**

Tackle more projects in less time thanks to faster installation. It is more profitable than replacing the full system with new piping.

**Lower installation costs**

Reducing installation costs enables you to offer customers the most cost-effective solution and improve your competitive edge.

**Replace non-Daikin systems** **NON DAIKIN** **DAIKIN**

It is a trouble-free replacement solution for Daikin systems and for systems made by other manufacturers.

**Easy as one-two-three**

A simple solution for replacement technology enables you to handle more projects for more customers in less time and offer them the best price! Everybody wins.

### Compare installation steps

**Conventional solution**

- 1 Recover refrigerant
- 2 Remove units
- 3 Remove refrigerant pipes
- 4 Install new piping and wiring
- 5 Install new units
- 6 Leak test
- 7 Vacuum drying
- 8 Refrigerant charging
- 9 Collect contamination
- 10 Test operation

**VRV-Q**

- 1 Recover refrigerant
- 2 Remove units
- Re-use existing piping and wiring
- 3 Install new units
- 4 Leak test
- 5 Vacuum drying
- 6 Automatic refrigerant charging, cleaning and testing



**Up to 45% shorter installation time**

### Automatic refrigerant charge

The unique automatic refrigerant charge eliminates the need to calculate refrigerant volume and ensures that the system will operate perfectly. Not knowing the exact piping lengths because of changes or mistakes in case you didn't do the original installation or replacing a competitor installation no longer poses a problem.

### Automatic pipe cleaning

There is no need to clean inside piping as this is handled automatically by the VRV-Q unit. Finally the test operation is performed automatically to save time.



**One touch convenience:**

- > Measure and charge refrigerant
- > Automatic pipe cleaning
- > Test operation



# Replacement VRV, heat recovery

## Quick & quality replacement for R-22 and R-407C systems

- › Cost effective and fast replacement as only the outdoor and indoor unit needs to be replaced, meaning almost no work has to be carried out inside the building
- › Efficiency gains of more than 40% can be realized, thanks to technological developments in heat pump technology and the more efficient R-410A refrigerant
- › Less intrusive and time consuming installation compared to installing a new system, as the refrigerant piping can be maintained
- › Unique automatic refrigerant charge eliminates the need to calculate refrigerant volume and allows safe replacement of competitor replacement
- › Automatic cleaning of refrigerant piping ensures a clean piping network, even when a compressor breakdown has occurred
- › Possibility to add indoor units and increase capacity without changing the refrigerant piping
- › Possibility to spread the various stages of replacement thanks to the modular design of the VRV system
- › Accurate temperature control, fresh air provision, air handling units and Biddle air curtains all integrated in a single system requiring only one single point of contact (RXYQQ-T only)
- › Incorporates VRV IV standards & technologies: Variable Refrigerant
- › Temperature and full inverter compressors (RXYQQ-T only)
- › Free combination of outdoor units to meet installation space or efficiency requirements (RXYQQ-T only)



Already fully compliant to LOT 21 - Tier 2

Published data with real-life indoor units

Access all technical information on RQCEQ-P3 at [my.daikin.eu](http://my.daikin.eu) or click here

Outdoor unit System		RQCEQ	280P3	360P3	460P3	500P3	540P3	636P3	712P3	744P3	816P3	848P3
System	Outdoor unit module 1		RQE140P3	RQE180P3	RQE140P3		RQE180P3	RQE212P3	RQE140P3		RQE180P3	RQE212P3
	Outdoor unit module 2		RQE140P3	RQE180P3	RQE140P3	RQE180P3		RQE212P3	RQE180P3		RQE212P3	
	Outdoor unit module 3		-		RQE180P3		RQE212P3	RQE180P3	RQE212P3			
	Outdoor unit module 4		-		-		RQE212P3					
Capacity range	HP	10	13	16	18	20	22	24	26	28	30	
Cooling capacity	Prated,c	kW	28.0	36.0	46.0	50.0	54.0	60.0	70.0	72.0	78.0	80.0
Heating capacity	Prated,h	kW	32.0	40.0	52.0	56.0	60.0	67.2	78.4	80.8	87.2	89.6
Recommended combination			4x FXM063P7VEB	4x FXM063P7VEB + 2x FXM063P7VEB	4x FXM063P7VEB + 2x FXM080P7VEB	4x FXSQ32A2VEB + 8x FXSQ40A2VEB	12x FXSQ40A2VEB	3x FXSQ40A2VEB + 9x FXSQ50A2VEB	4x FXSQ32A2VEB + 9x FXSQ40A2VEB + 3x FXSQ50A2VEB	4x FXSQ32A2VEB + 6x FXSQ40A2VEB + 6x FXSQ50A2VEB	7x FXSQ40A2VEB + 9x FXSQ50A2VEB	4x FXSQ40A2VEB + 12x FXSQ50A2VEB
ηs,c	%	200	185	191	201	198	186	194		204		187
ηs,h	%	159	157	161	150	148	157	153	155		157	
SEER		-										
SCOP		-										
Maximum number of connectable indoor units		21	28	34	39	43	47	52	56	60	64	
Indoor index connection	Min.	140	180	230	250	270	318	356	372	408	424	
	Nom.	280	360	500		540	636	712	744	816	848	
	Max.	364	468	598	650	702	827	926	967.0	1,061	1,102	
Piping connections	Liquid	OD	mm	9.52	12.7		15.9			19.1		
	Gas	OD	mm	22.2	25.4	28.6			34.9			
	Total piping length	System	Actual	m		300						
Power supply	Phase/Frequency/Voltage	Hz/V	3~/50/400									
Current - 50Hz	Maximum fuse amps (MFA)	A	30	40	50	60	70	80	90			
Outdoor unit module		RQEQ-P3	140P3			180P3			212P3			
Dimensions	Unit	HeightxWidthxDepth	mm			1,680x635x765						
Weight	Unit	kg		175			179					
Fan	Air flow rate	Cooling	Nom.	m <sup>3</sup> /min		95			110			
	Type	Propeller fan										
Sound power level	Cooling	Nom.	dBA		79			83			87	
Sound pressure level	Cooling	Nom.	dBA		-							
Operation range	Cooling	Min.~Max.	°CDB		-5~43			-				
	Heating	Min.~Max.	°CWB		-20~15.5							
Refrigerant	Type/GWP	R-410A/2,087.5										
	Charge	kg/TCO2Eq	10.3/21.5			10.6/22.1			11.2/23.4			
Power supply	Phase/Frequency/Voltage	Hz/V	3~/50/380-415									
Current - 50Hz	Maximum fuse amps (MFA)	A	15			20			22.5			



# Replacement VRV, heat pump



Outdoor Units



Access all technical information on RQYQ-P at [my.daikin.eu](http://my.daikin.eu) or click here



Access all technical information on RXYQQ-U at [my.daikin.eu](http://my.daikin.eu) or click here

Outdoor unit		RXYQQ/RQYQ-P	140P	8U	10U	12U	14U	16U	18U	20U
Capacity range		HP	5	8	10	12	14	16	18	20
Cooling capacity	Prated,c	kW	14.0	22.4	28.0	33.5	40.0	45.0	50.4	52.0
	Prated,h	kW	16.0	13.7	16.0	18.4	20.6	23.2	27.9	31.0
Heating capacity	Max.	kW	-	25.0	31.5	37.5	45.0	50.0	56.5	63.0
	6°CWB									
Recommended combination			4 x FXSQ32A2VEB	4 x FXFQ50AVEB	4 x FXFQ63AVEB	6 x FXFQ50AVEB	1 x FXFQ50AVEB + 5 x FXFQ63AVEB	4 x FXFQ63AVEB + 2 x FXFQ80AVEB	3 x FXFQ50AVEB + 5 x FXFQ63AVEB	2 x FXFQ50AVEB + 6 x FXFQ63AVEB
η <sub>s,c</sub>		%	194	302.4	267.6	247.8	250.7	236.5	238.3	233.7
η <sub>s,h</sub>		%	137	167.9	168.2	161.4	155.4	157.8	163.1	156.6
SEER			-	7.6	6.8	6.3		6.0		5.9
SCOP			-	4.3		4.1	4.0		4.2	4.0
Maximum number of connectable indoor units			10				64 (1)			
Indoor index connection	Min.		62.5	100.0	125.0	150.0	175.0	200.0	225.0	250.0
	Nom.		125							
	Max.		162.5	260.0	325.0	390.0	455.0	520.0	585.0	650.0
Dimensions	Unit	HeightxWidthxDepth	mm			1,680x635x765		1,685x930x765		
Weight	Unit		kg			175		198		275
Fan	Air flow rate	Cooling	Nom.		m <sup>3</sup> /min		95			
	Sound power level	Cooling	Nom.		dB(A)		79	78.0	79.1	83.4
Sound pressure level	Cooling	Nom.		dB(A)		-	57.0		61.0	60.0
	Operation range	Cooling	Min.~Max.		°CDB		-5~43		-5.0~43.0	
Refrigerant	Heating	Min.~Max.		°CWB		-20~15.5		-20.0~15.5		
	Type/GWP	R-410A/2,087.5								
Piping connections	Charge	kg/TCO2Eq	11.1/23.2	5.9/12.3	6.0/12.5	6.3/13.2	10.3/21.5	11.3/23.6	11.7/24.4	11.8/24.6
	Liquid OD	mm	9.52	9.52		12.7				15.9
Power supply	Gas OD	mm	15.9	19.1	22.2	28.6				
	Total piping length	System	Actual		m		300			
Phase/Frequency/Voltage	Hz/V		3~/50/380-415			3N~/50/380-415				
Current - 50Hz	Maximum fuse amps (MFA)	A	15	20	25	32		40		50

Outdoor unit System + Module		RXYQQ	22U	24U	26U	28U	30U	32U	34U	36U	38U	40U	42U	
System	Outdoor unit module 1		RXYQQ10U	RXYQQ8U	RXYQQ12U			RXYQQ16U			RXYQQ8U	RXYQQ10U		
	Outdoor unit module 2		RXYQQ12U	RXYQQ16U	RXYQQ14U	RXYQQ16U	RXYQQ18U	RXYQQ16U	RXYQQ18U	RXYQQ20U	RXYQQ10U	RXYQQ12U	RXYQQ16U	
	Outdoor unit module 3												RXYQQ20U	RXYQQ18U
Capacity range		HP	22	24	26	28	30	32	34	36	38	40	42	
Cooling capacity	Prated,c	kW	61.5	67.4	73.5	78.5	83.9	90.0	95.4	97.0	102.4	111.9	118.0	
	Prated,h	kW	34.4	36.9	39.0	41.6	46.3	46.4	51.1	54.2	60.7	62.3	62.4	
Heating capacity	Max.	kW	69.0	75.0	82.5	87.5	94.0	100.0	106.5	113.0	119.5	125.5	131.5	
	6°CWB													
Recommended combination			6 x FXFQ50AVEB + 4 x FXFQ63AVEB + 2 x FXFQ80AVEB	4 x FXFQ50AVEB + 4 x FXFQ63AVEB + 2 x FXFQ80AVEB	7 x FXFQ50AVEB + 5 x FXFQ63AVEB	6 x FXFQ50AVEB + 4 x FXFQ63AVEB + 2 x FXFQ80AVEB	9 x FXFQ50AVEB + 5 x FXFQ63AVEB + 2 x FXFQ80AVEB	8 x FXFQ63AVEB + 4 x FXFQ80AVEB + 2 x FXFQ50AVEB	3 x FXFQ50AVEB + 9 x FXFQ63AVEB + 2 x FXFQ80AVEB	2 x FXFQ50AVEB + 10 x FXFQ63AVEB + 2 x FXFQ80AVEB	6 x FXFQ50AVEB + 10 x FXFQ63AVEB + 2 x FXFQ80AVEB	9 x FXFQ50AVEB + 9 x FXFQ63AVEB	12 x FXFQ63AVEB + 4 x FXFQ80AVEB	
η <sub>s,c</sub>		%	274.5	269.9	264.2	257.8	256.8	251.7	253.3	250.8	272.4	263.5	261.2	
η <sub>s,h</sub>		%	171.2	167.0	164.6	166.0	169.8	163.1	166.2	162.4	167.5	170.0	165.5	
SEER			6.9	6.8	6.7	6.5		6.4		6.3	6.9	6.7	6.6	
SCOP			4.4	4.3	4.2		4.3	4.2		4.1	4.3		4.2	
Maximum number of connectable indoor units			64											
Indoor index connection	Min.		275.0	300.0	325.0	350.0	375.0	400.0	425.0	450.0	475.0	500.0	525.0	
	Nom.													
	Max.		715.0	780.0	845.0	910.0	975.0	1,040.0	1,105.0	1,170.0	1,235.0	1,300.0	1,365.0	
Piping connections	Liquid OD	mm	15.9											
	Gas OD	mm	28.6		34.9				19.1			41.3		
Power supply	Total piping length	System	Actual		m		300							
	Phase/Frequency/Voltage	Hz/V		3N~/50/380-415										
Current - 50Hz	Maximum fuse amps (MFA)	A	63				80				100			

Actual number of connectable indoor units depends on the indoor unit type (VRV indoor, Hydrobox, RA indoor, etc.) and the connection ratio restriction for the system (50% <= CR <= 130%)

# Water cooled VRV IV W<sup>+</sup> series

Ideal for high rise buildings,  
using water as heat source

Unified range  
for **heat pump**  
& **heat recovery**  
and **standard**  
& **geothermal**  
series



#### Indoor units

VRV type indoor units OR  
Residential type indoor units  
(such as Daikin Emura, ...)



#### Control systems



#### Air curtain

Biddle Air curtain for VRV (CYV)



#### Hot water

High temperature hydrobox  
Low temperature hydrobox



#### Ventilation

Heat Reclaim ventilation (ALB/VAM/  
VKM) AHU connection kit



Widest range of BS boxes for the fastest installation

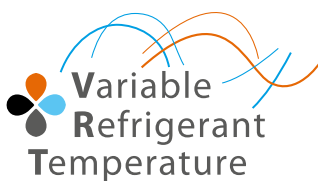

## VRV IV standards: Variable refrigerant temperature

Customize your VRV for best seasonal efficiency & comfort

## VRV configurator

Software for simplified commissioning, configuration and customisation

- › 7 segment display
- › Full inverter compressors
- › Connectable to stylish indoor units
- › Connectable to LT hydrobox
- › Connectable to HT hydrobox
- › Reluctance brushless DC compressor
- › Sine wave DC inverter
- › Manual demand function

For more information on these features refer to the VRV IV technologies tab

# Water-to-air heat pump



Outdoor Units

## Welcome a new range of features

### More flexibility

- › Mixed connection of HT hydroboxes and VRV indoor units
- › Connects to stylish indoor units such as Daikin Emura, Nexura, ... (no mixed connection with other indoors possible)
- › Extension of the range: 8-10-12-14HP, combinable up to 42HP while keeping the most compact casing in the market
- › Extended piping length up 165m (actual)
- › Extended indoor unit height difference to 30m

### More capacity

- › Up to 72% increased capacity (!) per model thanks to new compressor and larger heat exchanger

### Easier commissioning & customisation

- › 7 segment display
- › 2 analogue input signals allowing external control of
  - ON-OFF (e.g. compressor)
  - Operation mode (cooling / heating)
  - Limit of capacity
  - Error signal

### Total solution



Daikin Emura  
wall mounted unit



Nexura  
Floor standing unit

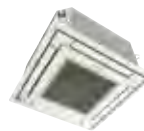

Fully flat cassette



Intelligent Manager



Biddle air curtain



Air handling unit for ventilation



Low temperature hydrobox



High temperature hydrobox

### Most compact casing in the market!



8 to 14 HP

16 to 28 HP

30 to 42 HP

### Unique zero heat dissipation principle



- › No need for ventilation or cooling in the technical room
- › Control heat dissipation to achieve maximum efficiency: set target technical room temperature and unit regulates actual heat dissipation

## With all existing standard functions

### Indoor installation makes unit invisible from the outside

- › Seamless integration in the surrounding architecture as you cannot see the unit
- › Highly suited for sound sensitive areas as there is no external operation sound
- › Very flexible indoor installation as there is no heat dissipation
- › Superior efficiency, even in the most extreme outside conditions, especially in geothermal operation



### Variable water flow control

- › The variable water flow control option reduces excessive energy use by the circulation pump.
- › By controlling a variable water valve, the water flow is reduced when possible, saving energy.
- › Via 0~10 volt

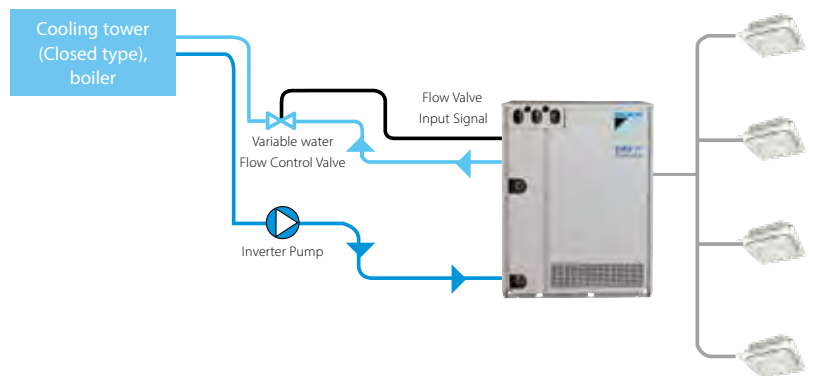

### Lower refrigerant concentration levels

Water-cooled VRV systems typically have less refrigerant per system making it ideal to comply with the EN378 legislation limiting the amount of refrigerant in hospitals and hotels.

### The refrigerant levels remain limited thanks to:

- › limited distance between outdoor and indoor unit
- › modularity: enabling small systems per floor instead of one big system. Thanks to the water circuit heat recovery is still possible in the entire building

### Single port



BS1Q 10,16,25A

### Multi port: 4 – 6 – 8 – 10 – 12 – 16



BS 4 Q14 A



BS 6, 8 Q14 A



BS 10, 12 Q14 A



BS 16 Q14 A

### Maximum design flexibility and installation speed

Quickly and flexibly design your system with a unique range of single and multi BS boxes. A wide variety of compact and lightweight multi BS boxes greatly reduces installation time. Free combination of single and multi BS boxes

### 2-stage heat recovery

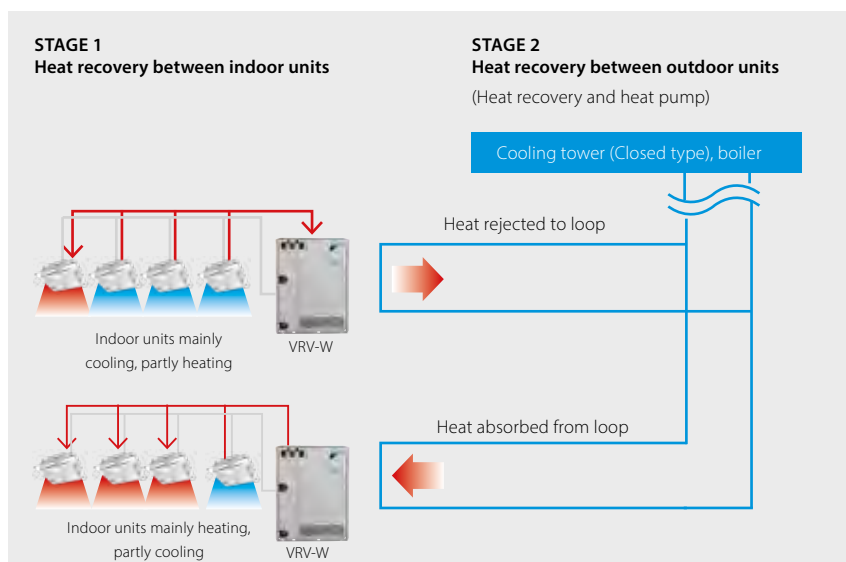

### Stacked configuration

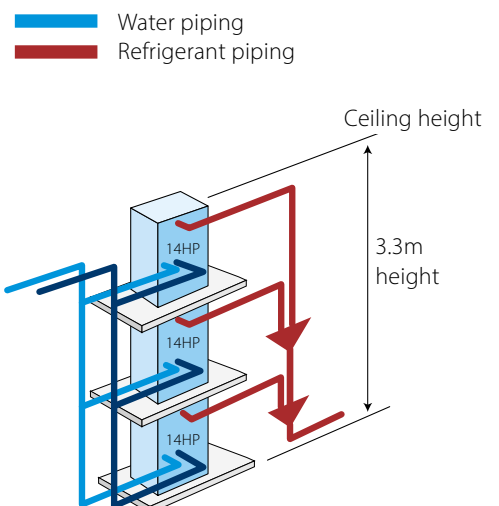

# Crystal Tower

BREEAM Design Phase: Excellent rating

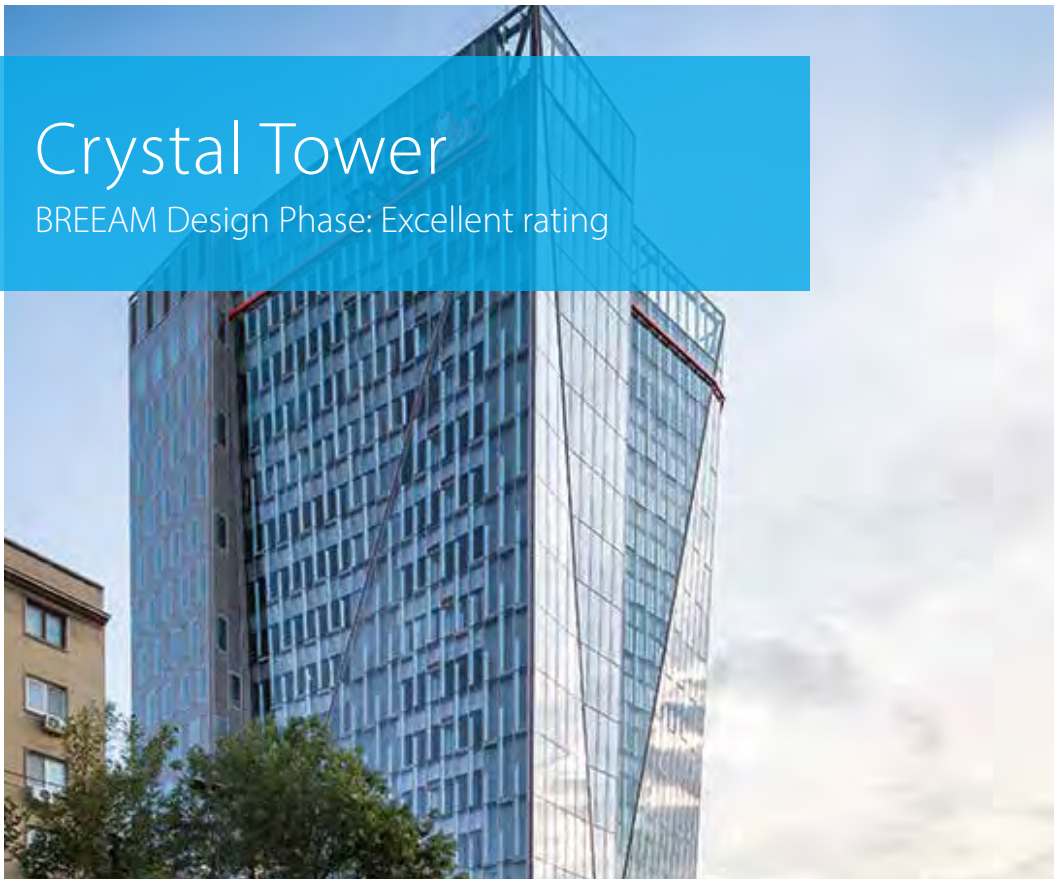

## A great and well-known example of a Daikin Total Solution leading to high energy-efficient HVAC consumption

- › A combination of VRV, Sky Air and Applied systems ensuring all offices and common areas are fully air conditioned.
- › Water-cooled VRV as the main contributor to total HVAC energy efficiency due to its two-stage heat recovery system.
- › Flexibility: individual thermal control and comfort with VRV on each floor and space.
- › Problem-free connection between Daikin units and the LonWorks BMS system ensures the building's total energy consumption is properly monitored and controlled.

### Location

48 Lancu de Hunedoara Boulevard  
Bucharest Romania

### Building details

Built-up area: 24,728 m<sup>2</sup>  
Total usable area: 20,020 m<sup>2</sup>  
Floors: 4 basements, 15 floors, technical floor  
Building height: 72 m  
Office space per level: approx. 1,000 m<sup>2</sup>

### Daikin systems installed

- › 67 x VRV water-cooled units
- › 2 x VRV outdoor heat pump units
- › 289 VRV indoor units (265 ducts, 24 x cassettes)
- › 5 x Sky Air with Roundflow Cassettes
- › 4 x air-cooled water chillers
- › 11 x DMS504B51 (LonWorks gateway)

### Awards

- › Green Building of the Year 2012 (ROGBC)
- › Environmental Social & Sustainability award (ESSA)

# Innovations

for maximum flexibility and ease of installation

Horizontal or vertical piping connection

Highly improved efficiency thanks to enlarged heat exchanger

Easy access to components

Easy front plate removal

Rotating switchbox

step 1

step 2

980mm

767mm

560mm



## Zero heat dissipation principle

- › No need for ventilation or cooling of the technical room
- › Enhancing installation flexibility and reliability of parts

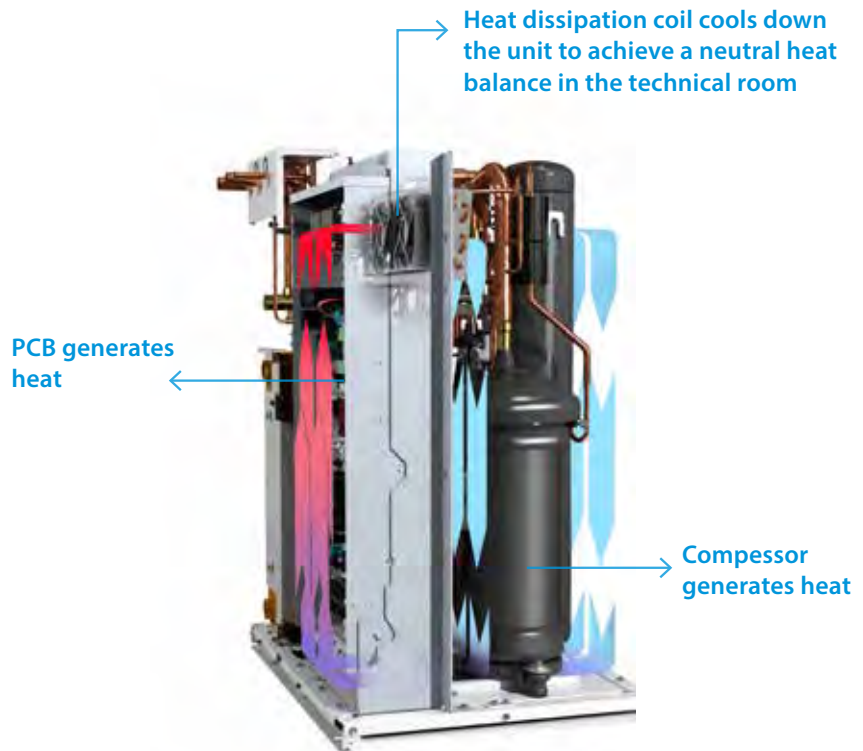

Minimal technical room space required.

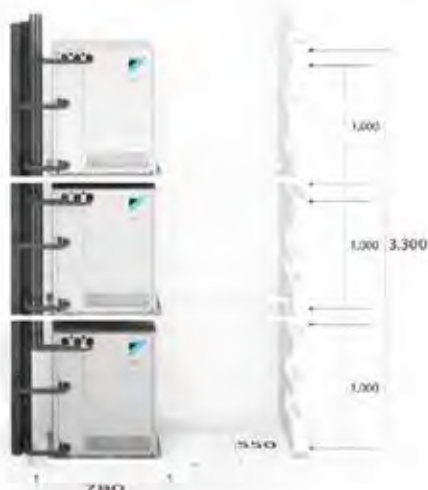

**VRV IV** technology

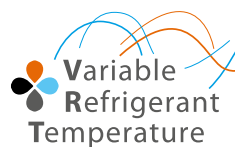

- › VRV configurator
- › 7 segment display

# Application

## example

Closed evaporative cooling tower used for cooling,  
Chiller used for heating

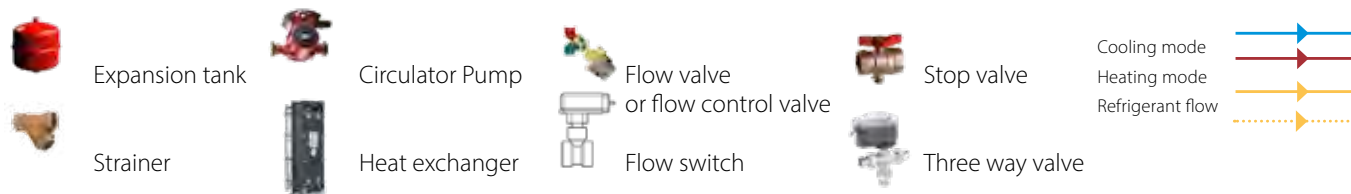
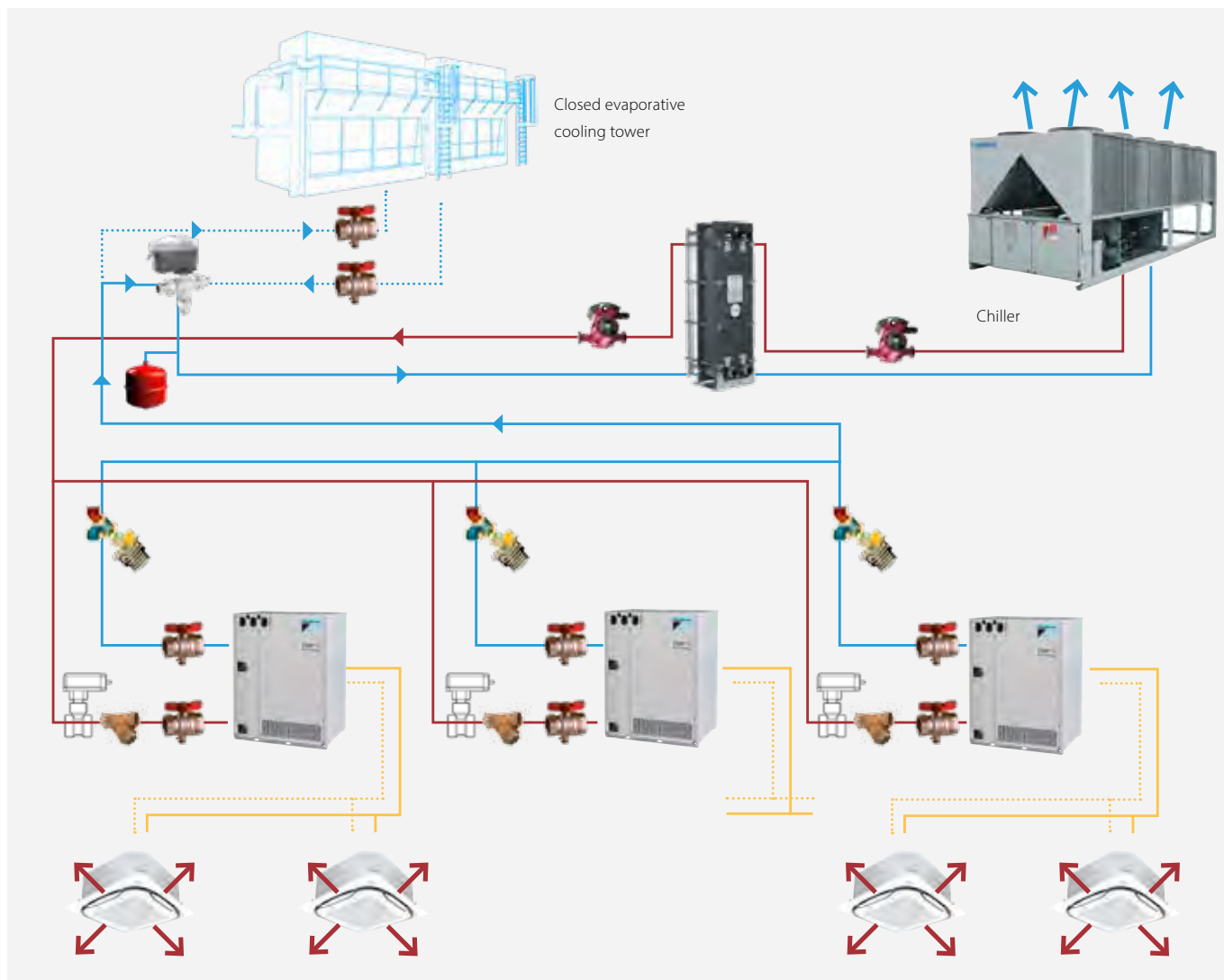

### Benefits of this setup

- > Chiller is only used when cooling tower capacity is not enough and/or when cooling and heating load of VRV is unbalanced → very energy efficient installation
- > In case the chiller is operating, a renewable heat source (air) is used, contributing to BREEAM score.
- > It is possible to downsize the cooling tower, making the installation more compact

### When to use?

- > When there is anyway a chiller used for other purposes in the building
- > When space for outdoor installation is limited
- > Efficiency / green building certification schemes oriented projects

# Application example

Dry cooler used for cooling, boiler used for heating

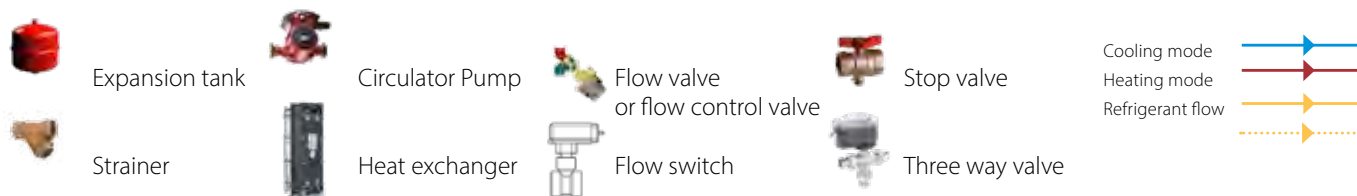
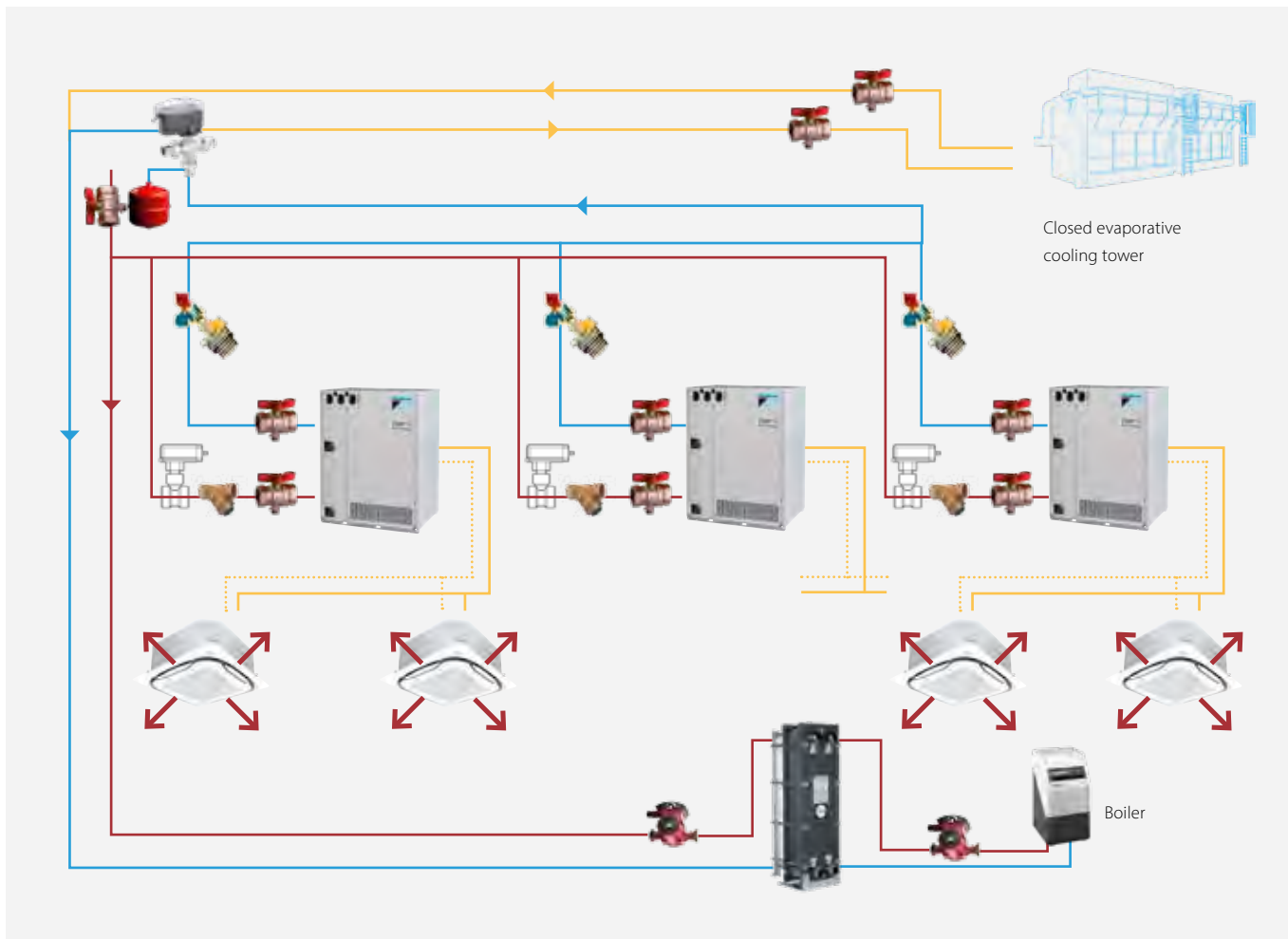

## Benefits of this setup

- Simple, cost efficient. Good option to use VRV technology in high-rise building
- Does not make any special demand to the building/project/installation location
- Provides high efficiency as for hotel application it is usual to have simultaneous cooling and heating load.
- Heat recovery process in the water loop often allows

the water temperature to stay within acceptable range even without using drycooler and boiler.

## When to use?

- > For high-rise buildings or other places where VRV Water Cooled is preferable because of installation conditions

# Application

## example

### Geothermal operation

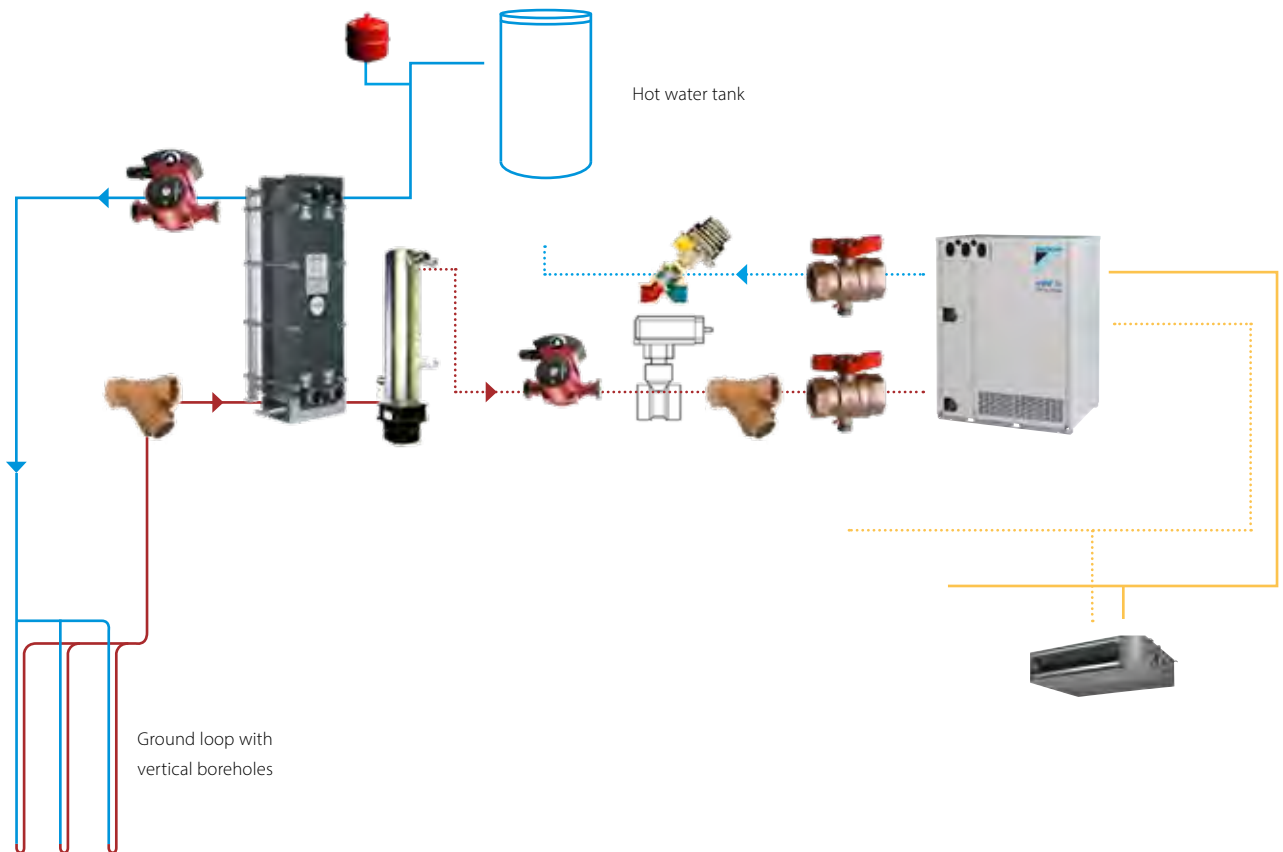

Expansion tank



Circulator Pump



Heat exchanger



Flow switch

Cooling mode

Heating mode

Refrigerant flow



Liquid heater



Buffer tank



Flow valve or flow control valve



Stop valve



Three way valve

#### Benefits of this setup

- > Very energy efficient
- > Ground loop can be in service for a very long time, so future equipment upgrades/replacements are easy
- > Vertical boreholes provide more stable water temperature (= Constant high efficiency) and do not occupy a lot of ground space.

#### When to use?

- > When the soil is suitable for geothermal loops and there is availability of geothermal installation expertise locally
- > For the projects with high requirements to energy efficiency, green building certification oriented

# Ground loop

## Examples

### Open system

Uses water from a well or surface water (river, lake). The water is pumped back to a second well or surface water



#### Conditions:

- › At 20 m depth water has a constant temperature of 10°C through the year
- › Surface water cools down to 5°C during winter

- ✓ Can be the most economical type of geothermal system
- ✓ Constant ground water temperature has positive impact on heat pump efficiency
- ✗ Risk to damage system components because of water quality → a secondary loop might be required to protect the heat exchanger
- ✗ Water should be tested for acidity, mineral content, organic content and corrosiveness:
- ✗ In many areas open systems are prohibited due to environmental concerns

### Closed system

Uses water pipes that are buried in the ground and exchange heat with the ground



#### Vertical system conditions

- › Typical depth: 30-140 m. Below 15 m, the temperature of the ground is constant around 10°C

- ✓ Less surface space required
- ✓ Very constant ground temperature
- ✗ Expensive due to drilling cost

For smaller applications also horizontal loops can be used



#### Horizontal loop system

- › Typical trench depth: 1 – 2 m. The ground temperature varies, but always above 5°C (Exception: in cold areas)
- › Slinky loop: the plastic geothermal loop pipe is coiled in overlapped circles and flattened (Installed where there is not enough space for closed horizontal)

- ✓ Installation is easier and less expensive than vertical closed loops.
- ✗ Mainly for small applications as the property land should be large enough
- ✗ You cannot plant trees or build constructions over the land containing the loop.
- ✗ Glycol is needed to prevent freezing of the water.

# VRV IV water cooled+ series

Ideal for high rise buildings, using water as heat source

- › Environmental conscious solution: reduced CO2 emissions thanks to the use of geothermal energy as a renewable energy source and typical lower refrigerant levels making it ideal to comply with EN378
- › Covers all thermal needs of a building via a single point of contact: accurate temperature control, ventilation, air handling units, Biddle air curtains and hot water
- › Unique zero heat dissipation principle obviates the need for ventilation or cooling in the technical room, maximising installation flexibility
- › Wide range of indoor units: possibility to combine VRV with stylish indoor units (Daikin Emura, Nexura, ...)
- › Incorporates VRV IV standards & technologies: Variable Refrigerant Temperature, VRV configurator, 7-segment display and full inverter compressors
- › Developed for easy installation and servicing: choice between top or front connection for refrigerant piping and rotating switch box for easy access to serviceable parts
- › Compact & lightweight design can be stacked for maximum space saving: 42HP can be installed in less than 0,5m<sup>2</sup> floorspace
- › 2-stage heat recovery: first stage between indoor units, second stage between outdoor units thanks to the storage of energy in the water circuit
- › Unified model for heat pump and heat recovery version and geothermal and standard operation

- › Variable Water Flow control option increases flexibility and control
- › 2 analogue input signals allowing external control of ON-OFF, operation mode, error signal, ...
- › Contains all standard VRV features

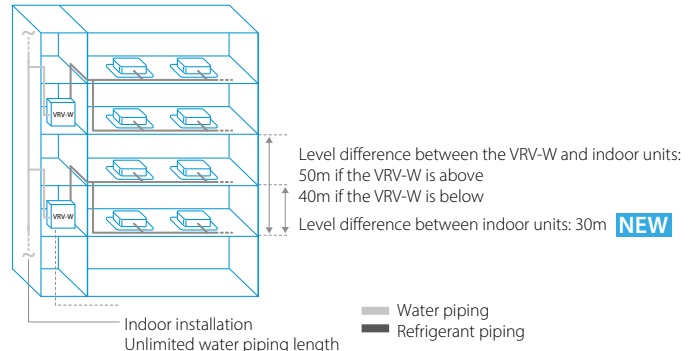

Already fully compliant to LOT 21 - Tier 2

Published data with real-life indoor units

Connectable stylish indoor units

		15 CLASS	20 CLASS	25 CLASS	35 CLASS	42 CLASS	50 CLASS	60 CLASS	71 CLASS
Daikin Emura - Wall mounted unit	FTXJ-MW/MS		•	•	•		•		
Wall mounted unit	CTXM-M	•							
Wall mounted unit	FTXM-N		•	•	•	•	•	•	•
Nexura - Floor standing unit	FVXG-K			•	•		•		
Floor standing unit	FVXM-F			•	•		•		
Flexi type unit	FLXS-B(9)			•	•		•	•	

BPMKS box needed to connect RA indoors to VRV IV (RYYQ / RXYQ)



Access all technical information on RWEYQ-T9 at [my.daikin.eu](http://my.daikin.eu) or click here

Outdoor unit		RWEYQ	8T9	10T9	12T9	14T9
Capacity range		HP	8	10	12	14
Cooling capacity	Prated,c	kW	22.4	28.0	33.5	40.0
Heating capacity	Prated,h	kW	25.0	31.5	37.5	45.0
	Max.	6°CWB	25.0	31.5	37.5	45.0
Recommended combination			4 x FXMQ50P7VEB	4 x FXMQ63P7VEB	6 x FXMQ50P7VEB	1 x FXMQ50P7VEB + 5 x FXMQ63P7VEB
ηs,c		%	326.8	307.8	359.0	330.7
ηs,h		%	524.3	465.9	436.0	397.1
SEER			8.4	7.9	9.2	8.5
SCOP			13.3	11.8	11.1	10.1
Maximum number of connectable indoor units				64 (1)		
Indoor index connection	Min.		100.0	125.0	150.0	175.0
	Nom.					
	Max.		300.0	375.0	450.0	525.0
Dimensions	Unit	HeightxWidthxDepth	mm			
Weight	Unit		195		197	
Sound power level	Cooling	Nom.	65.0	71.0	72.0	74.0
	Cooling	Nom.	48.0	50.0	56.0	58.0
Operation range	Inlet water temperature	Cooling	Min.~Max.	10~45		
		Heating	Min.~Max.	10~45		
	Temperature around casing	Max.	°CDB			
		Humidity around casing	Cooling-Heating	Max.	80~80	
Refrigerant	Type/GWP		R-410A/2,087.5			
Piping connections	Charge	kg/CO2Eq	7.9/16.5		9.6/20.0	
	Liquid	OD	mm			
	Gas	OD	mm			
	HP/LP gas	OD	19.1 (2)	22.2 (2)	127	
	Drain	Size	mm			
	Water	Inlet/Outlet	Size	14mm OD/ 10mm ID		
Power supply	Total piping length	System	Actual			
	Phase/Frequency/Voltage		m			
Current - 50Hz	Maximum fuse amps (MFA)	A	20		25	
			ISO 228-G1 1/4 B/ISO 228-G1 1/4 B			
			500			
			3N~/50/380-415			



### Stage 1 heat recovery between indoor units

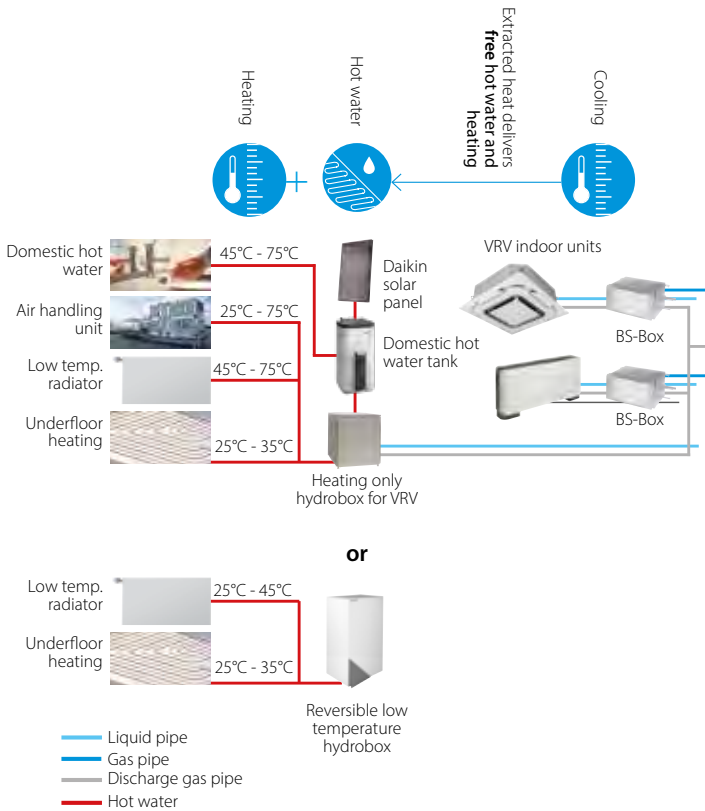

### Stage 2 heat recovery between outdoor units

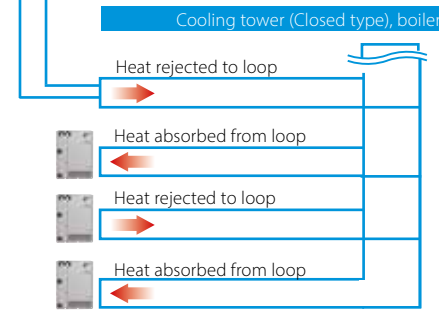

\* Above system configuration are for illustration purpose only.

Outdoor unit System		RWEYQ	16T9	18T9	20T9	22T9	24T9	26T9	28T9
System	Outdoor unit module 1		RWEYQ8T		RWEYQ10T		RWEYQ12T		RWEYQ14T
	Outdoor unit module 2		RWEYQ8T	RWEYQ10T					RWEYQ14T
Capacity range		HP	16	18	20	22	24	26	28
Cooling capacity	Prated,c	kW	44.8	50.4	56.0	61.5	67.0	73.5	80.0
Heating capacity	Prated,h	kW	50.0	56.5	62.5	69.0	75.0	82.5	90.0
	Max.	6°CWB	kW	50.0	56.5	62.5	69.0	75.0	82.5
ηs,c		%	307.6	308.7	298.1	311.3	342.6	322.5	306.1
ηs,h		%	459.2	491.1	466.8	447.9	434.5	406.9	387.9
SEER			7.9		7.7	8.0	8.8	8.3	7.9
SCOP			11.7	12.5	11.9	11.4	11.1	10.4	9.9
Recommended combination			4 x FXMQ63P7VEB + 2 x FXMQ80P7VEB	6 x FXMQ50P7VEB + 4 x FXMQ63P7VEB	4 x FXMQ50P7VEB + 4 x FXMQ63P7VEB	8 x FXMQ63P7VEB	12 x FXMQ50P7VEB	7 x FXMQ50P7VEB + 5 x FXMQ63P7VEB	2 x FXMQ50P7VEB + 10 x FXMQ63P7VEB
Maximum number of connectable indoor units			64 (1)						
Indoor index connection	Min.		200.0	225.0	250.0	275.0	300.0	325.0	350.0
	Nom.								
	Max.		600.0	675.0	750.0	825.0	900.0	975.0	1,050.0
Piping connections	Liquid	OD	mm	127		159			191
	Gas	OD	mm		28.6 (2)			34.9 (2)	
	HP/LP gas	OD	mm	22.2 (3) / 28.6 (4)		28.6 (3) / 28.6 (4)		28.6 (3) / 34.9 (4)	
	Total piping length	System	Actual	m		500			
Power supply	Phase/Frequency/Voltage		3N~/50/380-415						
Current - 50Hz	Maximum fuse amps (MFA)	A	32		35	40		50	

Outdoor unit System		RWEYQ	30T9	32T9	34T9	36T9	38T9	40T9	42T9
System	Outdoor unit module 1		RWEYQ10T			RWEYQ12T		RWEYQ14T	
	Outdoor unit module 2		RWEYQ10T		RWEYQ12T		RWEYQ14T		
	Outdoor unit module 3		RWEYQ10T	RWEYQ12T					
Capacity range		HP	30	32	34	36	38	40	42
Cooling capacity	Prated,c	kW	84.0	89.5	95.0	100.5	107.0	113.5	120.0
Heating capacity	Prated,h	kW	94.5	100.5	106.5	112.5	120.0	127.5	135.0
	Max.	6°CWB	kW	94.5	100.5	106.5	112.5	120.0	127.5
Recommended combination			12 x FXMQ63P7VEB	6 x FXMQ50P7VEB + 8 x FXMQ63P7VEB	12 x FXMQ50P7VEB + 4 x FXMQ63P7VEB	18 x FXMQ50P7VEB	13 x FXMQ50P7VEB + 5 x FXMQ63P7VEB	8 x FXMQ50P7VEB + 10 x FXMQ63P7VEB	3 x FXMQ50P7VEB + 15 x FXMQ63P7VEB
ηs,c		%	308.3	318.2	342.5	352.3	338.8	341.4	332.9
ηs,h		%	467.2	456.1	447.0	438.5	419.4	404.4	391.2
SEER			7.9	8.2	8.8	9.0	8.7		8.5
SCOP			11.9	11.6	11.4	11.2	10.7	10.3	10.0
Maximum number of connectable indoor units			64 (1)						
Indoor index connection	Min.		375.0	400.0	425.0	450.0	475.0	500.0	525.0
	Nom.								
	Max.		1,125.0	1,200.0	1,275.0	1,350.0	1,425.0	1,500.0	1,575.0
Piping connections	Liquid	OD	mm			19.1 (2)			
	Gas	OD	mm		34.9			41.3	
	HP/LP gas	OD	mm	28.6 (3) / 34.9 (4)		28.6 (3) / 34.9 (4)		41.3 (3) / 34.9 (4)	
	Total piping length	System	Actual	m		500			
Power supply	Phase/Frequency/Voltage		3N~/50/380-415						
Current - 50Hz	Maximum fuse amps (MFA)	A	50	63		80			

(1) Actual number of connectable indoor units depends on the indoor unit type (VRV indoor, Hydrobox, RA indoor, etc.) and the connection ratio restriction for the system (50% ≤ CR ≤ 130%) | (2) In case of heat pump system, gas pipe is not used (3) In case of heat recovery system (4) In case of heat pump system

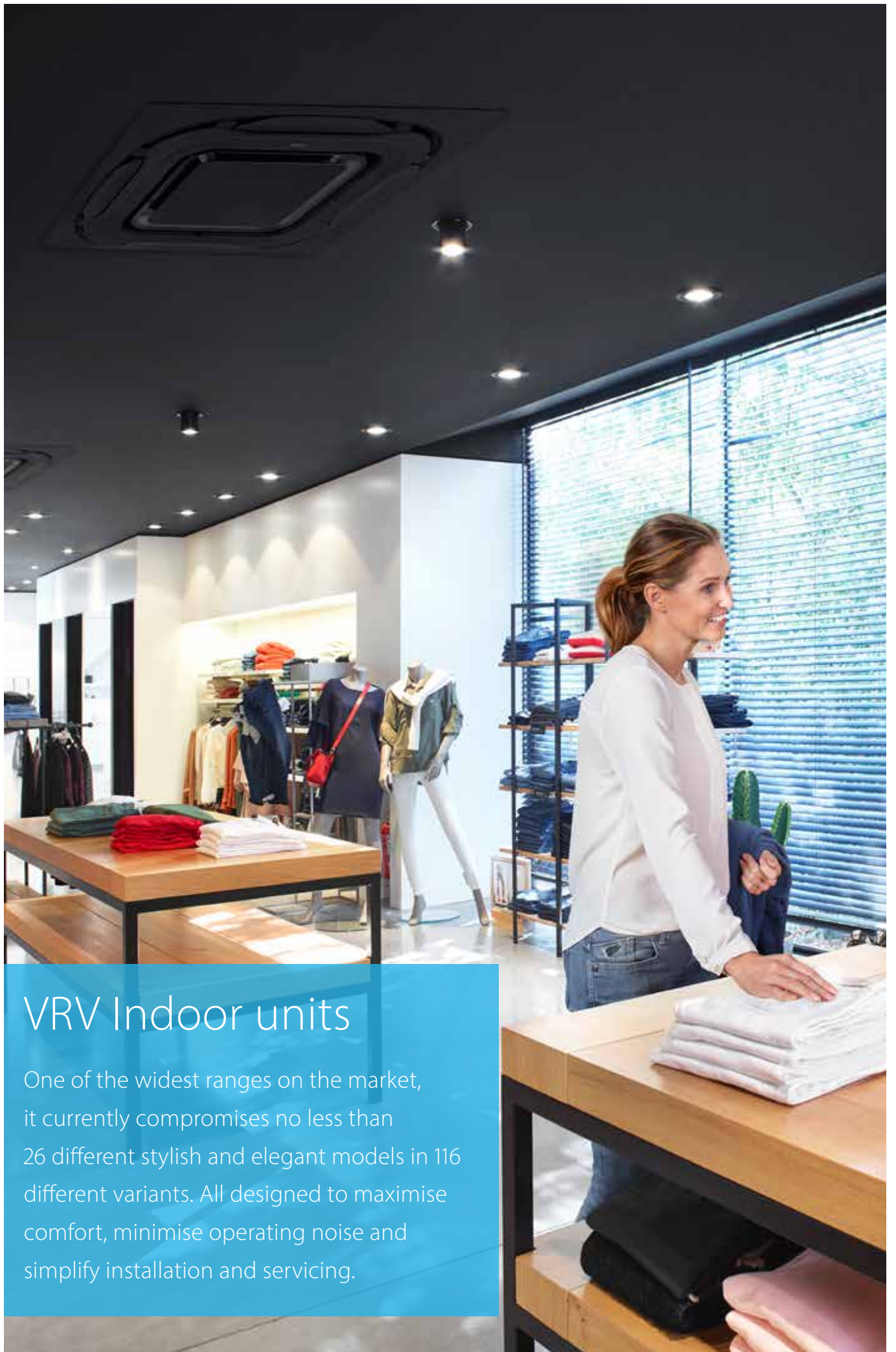

## VRV Indoor units

One of the widest ranges on the market, it currently comprises no less than 26 different stylish and elegant models in 116 different variants. All designed to maximise comfort, minimise operating noise and simplify installation and servicing.



# VRV Indoor units

**NEW  
PANELS**

## VRV indoor units

### Ceiling mounted cassette units

<b>UNIQUE</b>	FXFQ-B	107
<b>UNIQUE</b>	FXZQ-A	108
	FXCQ-A	112
	FXKQ-MA	113

### Concealed ceiling units

<b>UNIQUE</b>	Auto cleaning filter for concealed ceiling units	114
	Multi zoning kit	115
<b>SLIMMEST IN CLASS</b>	FXDQ-A3	116
	FXSQ-A	117
	FXMQ-P7 / FXMQ-MB	118

### Wall mounted unit

	FXAQ-A	119
--	--------	-----

### Ceiling suspended units

	FXHQ-A	120
<b>UNIQUE</b>	FXUQ-A	121

### Floor standing units

<b>SLIMMEST IN CLASS</b>	FXNQ-A	122
	FXLQ-P	123

## Stylish indoor units

### BPMKS

Accessory to connect stylish indoor units	124
---	-----

### Wall mounted

FTXJ-MW/MS	126
CTXM-M / FTXM-N	127

**UNIQUE  
DESIGN UNIT**

### Floor standing

FVXG-K	129
FVXM-F	130















**UNIQUE  
RADIATING PANEL**

### Flexi type unit

FLXS-B(9)	131
-----------	-----

# Products overview

Capacity class (kW)

Type	Model	Product name	15	20	25	32	40	50	63	71	80	100	125	140	200	250		
Ceiling mounted cassette	<p><b>UNIQUE</b></p> <p>360° air discharge for optimum efficiency and comfort</p> <ul style="list-style-type: none"> <li>› Auto cleaning function ensures high efficiency</li> <li>› Intelligent sensors save energy and maximize comfort</li> <li>› Flexibility to suit every room layout</li> <li>› Lowest installation height in the market!</li> <li>› Widest choice ever in decoration panel designs and colors</li> </ul>	 <p>FXFQ-B</p> 		•	•	•	•	•	•		•	•	•					
	<p><b>UNIQUE</b></p> <p>Unique design that integrates fully flat into the ceiling</p> <ul style="list-style-type: none"> <li>› Perfect integration in standard architectural ceiling tiles</li> <li>› Blend of iconic design and engineering excellence</li> <li>› Intelligent sensors save energy and maximize comfort</li> <li>› Small capacity unit developed for small or well-insulated rooms</li> <li>› Flexibility to suit every room layout</li> </ul>	 <p>FXZQ-A</p> 	•	•	•	•	•	•										
	<p>Thin, lightweight design installs easily in narrow ceiling spaces</p> <ul style="list-style-type: none"> <li>› Depth of all units is 620mm, ideal for narrow ceiling spaces</li> <li>› Flexibility to suit every room layout</li> <li>› Reduced energy consumption thanks to DC fan motor</li> <li>› The flaps close entirely when the unit is not operating</li> <li>› Optimum comfort with automatic air flow adjustment to the required load</li> </ul>	<p>FXCQ-A</p> 		•	•	•	•	•	•			•		•				
	<p>1-way blow unit for corner installation</p> <ul style="list-style-type: none"> <li>› Compact dimensions enable installation in narrow ceiling voids</li> <li>› Flexible installation thanks to different air discharge options</li> </ul>	<p>FXKQ-MA</p> 			•	•	•		•									
Concealed ceiling	<p>Slim design for flexible installation</p> <ul style="list-style-type: none"> <li>› Compact dimensions enable installation in narrow ceiling voids</li> <li>› Medium external static pressure up to 44Pa</li> <li>› Only grilles are visible</li> <li>› Small capacity unit developed for small of well-insulated rooms</li> <li>› Reduced energy consumption thanks to DC fan motor</li> </ul>	<p>FXDQ-A3</p> 	•	•	•	•	•	•										
	<p>Slimmest yet most powerful medium static pressure unit on the market!</p> <ul style="list-style-type: none"> <li>› Slimmest unit in class, only 245mm</li> <li>› Low operating sound level</li> <li>› Medium external static pressure up to 150Pa facilitates using flexible ducts of varying lengths</li> <li>› Automatic air flow adjustment function measures the air volume and static pressure and adjusts it towards the nominal air flow, guaranteeing comfort</li> </ul>	<p>FXSQ-A</p> 	•	•	•	•	•	•				•	•	•	•			
	<p>ESP up to 200, ideal for large sized spaces</p> <ul style="list-style-type: none"> <li>› Optimum comfort guaranteed no matter the length of ductwork or type of grilles, thanks to automatic air flow adjustment</li> <li>› Reduced energy consumption thanks to DC fan motor</li> <li>› Flexible installation as the air suction direction can be altered from rear to bottom suction</li> </ul>	<p>FXMQ-P7</p> 							•	•		•	•	•				
	<p>ESP up to 270, ideal for extra large sized spaces</p> <ul style="list-style-type: none"> <li>› Only grilles are visible</li> <li>› Large capacity unit: up to 31.5 kW heating capacity</li> </ul>	<p>FXMQ-MB</p> 														•	•	
Ceiling suspended	<p>For rooms with no false ceilings nor free floor space</p> <ul style="list-style-type: none"> <li>› Flat, stylish front panel is more easy to clean</li> <li>› Small capacity unit developed for small of well-insulated rooms</li> <li>› Reduced energy consumption thanks to DC fan motor</li> <li>› The air is comfortably spread up- and downwards thanks to 5 different discharge angles</li> </ul>	<p>FXAQ-A</p> 	•	•	•	•	•	•										
	<p>For wide rooms with no false ceilings nor free floor space</p> <ul style="list-style-type: none"> <li>› Ideal for comfortable air flow in wide rooms thanks to Coanda effect</li> <li>› Rooms with ceilings up to 3.8m can be heated or cooled very easily!</li> <li>› Can easily be installed in both new and refurbishment projects</li> <li>› Can even be mounted in corners or narrow spaces without any problem</li> <li>› Reduced energy consumption thanks to DC fan motor</li> </ul>	<p>FXHQ-A</p> 				•			•			•						
Floor standing	<p><b>UNIQUE</b></p> <p>Unique Daikin unit for high rooms with no false ceilings nor free floor space</p> <ul style="list-style-type: none"> <li>› Rooms with ceilings up to 3.5m can be heated up or cooled down very easily!</li> <li>› Can easily be installed in both new and refurbishment projects</li> <li>› Flexibility to suit every room layout</li> <li>› Reduced energy consumption thanks to DC fan motor</li> </ul>	<p>FXUQ-A</p> 									•		•					
	<p>For perimeter zone air conditioning</p> <ul style="list-style-type: none"> <li>› Can be installed in front of glass walls or free standing as both the front and the back are finished</li> <li>› Ideal for installation beneath a window</li> <li>› Requires very little installation space</li> <li>› Wall mounted installation facilitates cleaning beneath the unit</li> </ul>	<p>FXLQ-P</p> 		•	•	•	•	•	•									
	<p>Ideal for installation in offices, hotels and residential applications</p> <ul style="list-style-type: none"> <li>› Discretely concealed in the wall, leaving only the suction and discharge grilles visible</li> <li>› Can even be installed underneath a window</li> <li>› Requires very little installation space as the depth is only 200mm</li> <li>› High ESP allows flexible installation</li> </ul>	<p>FXNQ-A</p> 		•	•	•	•	•	•									
Cooling capacity (kW) <sup>1</sup>				1.7	2.2	2.8	3.6	4.5	5.6	7.1	8.0	9.0	11.2	14.0	16.0	22.4	28.0	
Heating capacity (kW) <sup>2</sup>				1.9	2.5	3.2	4.0	5.0	6.3	8.0	9.0	10.0	12.5	16.0	18.0	25.0	31.5	

(1) Nominal cooling capacities are based on: indoor temperature: 27°CDB, 19°CWB, outdoor temperature: 35°CDB, equivalent refrigerant piping: 5m, level difference: 0m

(2) Nominal heating capacities are based on: indoor temperature: 20°CDB, outdoor temperature: 7°CDB, 6°CWB, equivalent refrigerant piping: 5m, level difference: 0m

# Stylish indoor units overview

Depending on the application, Split and Sky Air indoor units can be connected to our VRV IV and VRV IV S-series outdoor units. Refer to the **outdoor unit portfolio** for combination restrictions.

Type	Model	Product name	Capacity class (kW)							Connectable outdoor unit						
			15	20	25	35	42	50	60	71	RYYQ-T	RXYQ-T(9)	RXYSQ-TV1 <sup>3</sup>	RXYSQ-TV1 <sup>3</sup>	RXYSQ-TV1 <sup>3</sup>	RWEYQ-T9 <sup>4</sup>
Ceiling mounted cassette	Round flow cassette (incl. auto-cleaning function <sup>1</sup> )	FCAG-B				•			•	•				✓		
	Fully flat cassette	FFA-A9			•	•			•	•				✓		
Concealed ceiling	Slim concealed ceiling unit	FDXM-F9			•	•			•	•				✓		
	Concealed ceiling unit with inverter-driven fan	FBA-A9				•			•	•				✓		
Wall mounted	Daikin Emura Wall mounted unit	FTXJ-MW/MS		•	•	•			•			✓	✓	✓	✓	✓
	Wall mounted unit	CTXM-M FTXM-N	•	•	•	•	•	•	•	•	•	✓	✓	✓	✓	✓
Ceiling suspended	Ceiling suspended unit	FHA-A9				•			•	•	•			✓		
Floor standing	Nexura floor standing unit	FVXG-K			•	•			•			✓	✓	✓	✓	✓
	Floor standing unit	FVXM-F			•	•			•			✓	✓	✓	✓	✓
	Flexi type unit	FLXS-B(9)			•	•			•	•		✓	✓	✓	✓	✓
	Concealed floor standing unit	FNA-A9			•	•			•	•				✓		

Auto cleaning filter option

<sup>1</sup> Decoration panel BYCQ140DG9 or BYCQ140DGF9 + BRC1E53A/B/C needed

<sup>2</sup> To connect stylish indoor units a BPMKS unit is needed





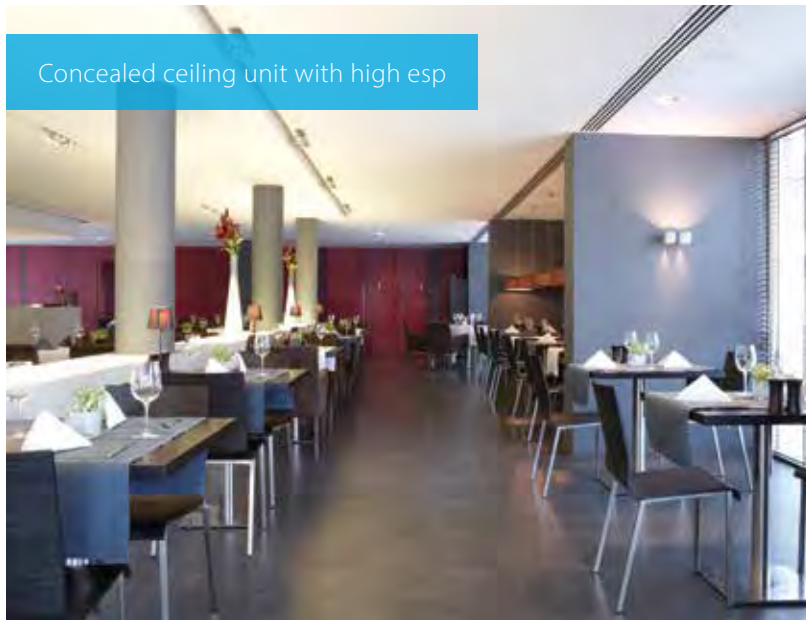

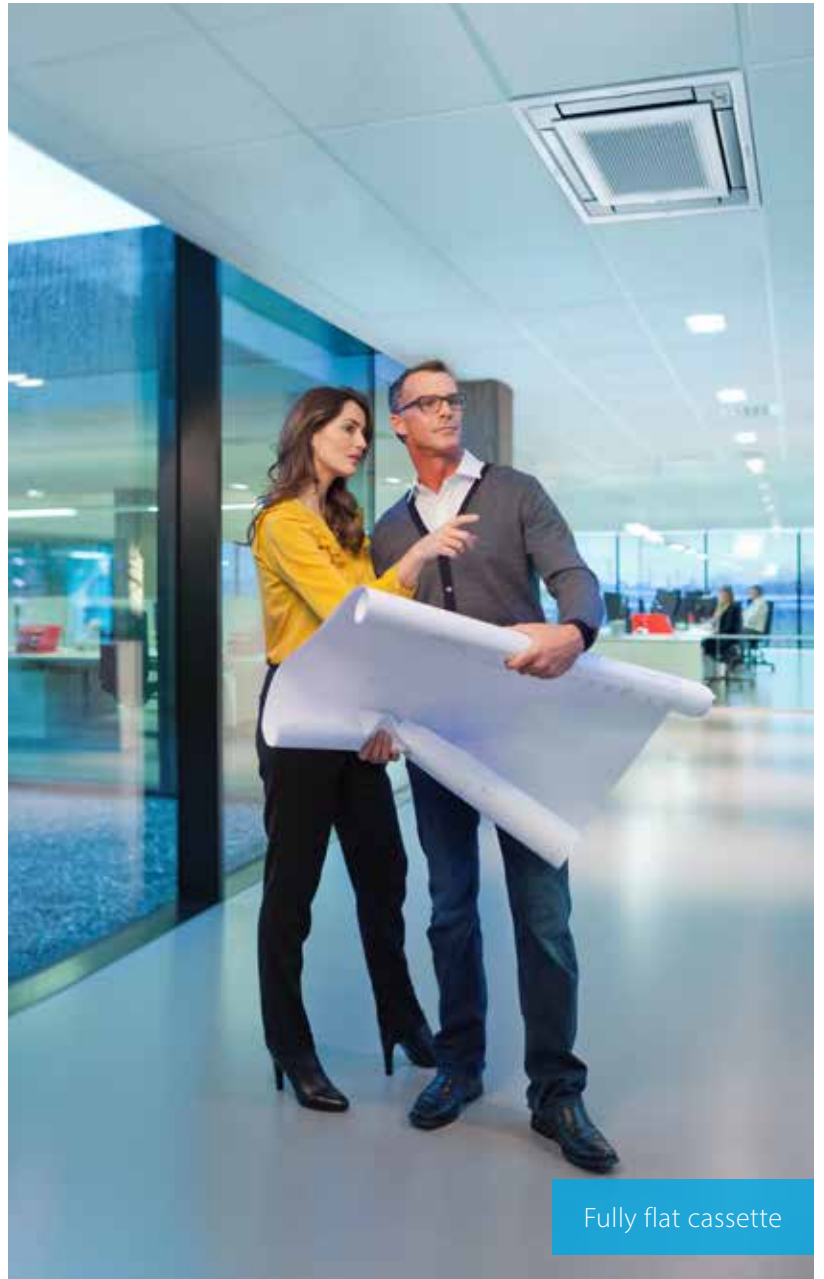











<sup>3</sup> A mix of RA indoor units and VRV indoor units is not allowed.

<sup>4</sup> Only in heat pump operation





Benefits overview **VRV**

We care		Home leave operation	During absence, indoor comfort levels can be maintained
		Fan only	The air conditioner can be used as fan, blowing air without cooling or heating
		Auto cleaning filter	The filter automatically cleans itself. Simplicity of upkeep means optimum energy efficiency and maximum comfort without the need for expensive or time-consuming maintenance
		Floor and presence sensor	The presence sensor directs the air away from any person detected in the room. The floor sensor detects the average floor temperature and ensures an even temperature distribution between ceiling and floor
Comfort		Draught prevention	When starting to warm up or when the thermostat is off, the air discharge direction is set horizontally and the fan to low speed, to prevent draught. After warming up, air discharge and fan speed are set as desired
		Whisper quiet	Daikin indoor units are whisper quiet. Also the outdoor units are guaranteed not to disturb the quiet of the neighbourhood
		Auto cooling-heating changeover	Automatically selects cooling or heating mode to achieve the set temperature
Air treatment		Air filter	Removes airborne dust particles to ensure a steady supply of clean air
Humidity control		Dry programme	Allows humidity levels to be reduced without variations in room temperature
Air flow		Ceiling soiling prevention	The air discharge of the indoor unit is specially designed to prevent air being blown against the ceiling to prevent ceiling stains
		Vertical auto swing	Possibility to select automatic vertical moving of the air discharge louvre, for uniform air flow and temperature distribution
		Fan speed steps	Multiple fan speeds to select, to optimize comfort levels
		Individual flap control	Individual flap control via the wired remote controller makes it simple to fix the position of each flap individually, to suit any new room configuration. Optional closure kits are available as well
Remote control & timer		Weekly timer	Timer can be set to start and stop operation anytime on a daily or weekly basis
		Infrared remote control	Infrared remote control with LCD to remotely control your indoor unit
		Wired remote control	Wired remote control to remotely control your indoor unit
		Centralised control	Centralised control to control several indoor units from one single point
		Multi zoning	Allows up to 6 individual climate zones with one indoor unit
Other functions		Auto-restart	The unit restarts automatically at the original settings after power failure
		Self-diagnosis	Simplifies maintenance by indicating system faults or operating anomalies
		Drain pump kit	Facilitates condensation draining from the indoor unit
		Multi tenant	The indoor unit's main power supply can be turned off when leaving the building or for servicing purposes

Ceiling mounted cassette units				Concealed ceiling units				Wall mounted unit	Ceiling suspended units		Floor standing units	
FXFQ-B	FXZQ-A	FXCQ-A	FXKQ-MA	FXDQ-A3	FXSQ-A	FXMQ-P7	FXMQ-MB	FXAQ-A	FXHQ-A	FXUQ-A	FXNQ-A	FXLQ-P
•	•	•	•	•	•	•	•	•	•	•	•	•
•	•	•	•	•	•	•	•	•	•	•	•	•
•				•								
•	•											
•	•		•							•		
•	•	•		•	•		•					
•	•	•	•	•	•	•	•	•	•	•	•	•
G1 F8 (optional)	G1	•	G1	•	G1 F8 (optional)	•	G1 F8 (optional)	•	G1	G1	G1	G1
•	•	•	•	•	•	•	•	•	•	•	•	•
•	•	•	•					•		•		
•	•	•	•									
3 + auto	3 + auto	3 + auto	2	3	3 + auto	3	2	2	3	3 + auto	2	2
•	•									•		
•	•	•	•	•	•	•	•	•	•	•	•	•
•	•	•	•	•	•	•	•	•	•	•	•	•
•	•	•	•	•	•	•	•	•	•	•	•	•
				•	•							
•	•	•	•	•	•	•	•	•	•	•	•	•
•	•	•	•	•	•	•	•	•	•	•	•	•
Standard	Standard	Standard	Standard	Standard	Standard	Standard	Optional	Optional	Optional	Standard		
•	•	(•)	(•)	•	•	•	(•)	•	(•)	(•)	•	•

# Round flow cassette

## 360° air discharge for improved comfort

- › Industry-first and proven design.
- › Wider flaps to even further improve equal temperature distribution

**NEW**

## More energy efficient and user-friendly than any other cassette

- › Running costs can be reduced down to 50% compared with standard solutions
- › Automatic filter cleaning.
- › Less time is required to maintain the filter: dust can be removed easily with a vacuum cleaner without opening the unit.

## Intelligent sensors improve efficiency and comfort even more

- › The presence sensor adjusts the set point if no one is detected in the room leading to up to 27% savings. It also automatically directs air flow away from any person to avoid draught.
- › The infrared floor sensor detects the average floor temperature and ensures even temperature distribution between ceiling and floor to prevent cold feet.



presence sensor floor sensor

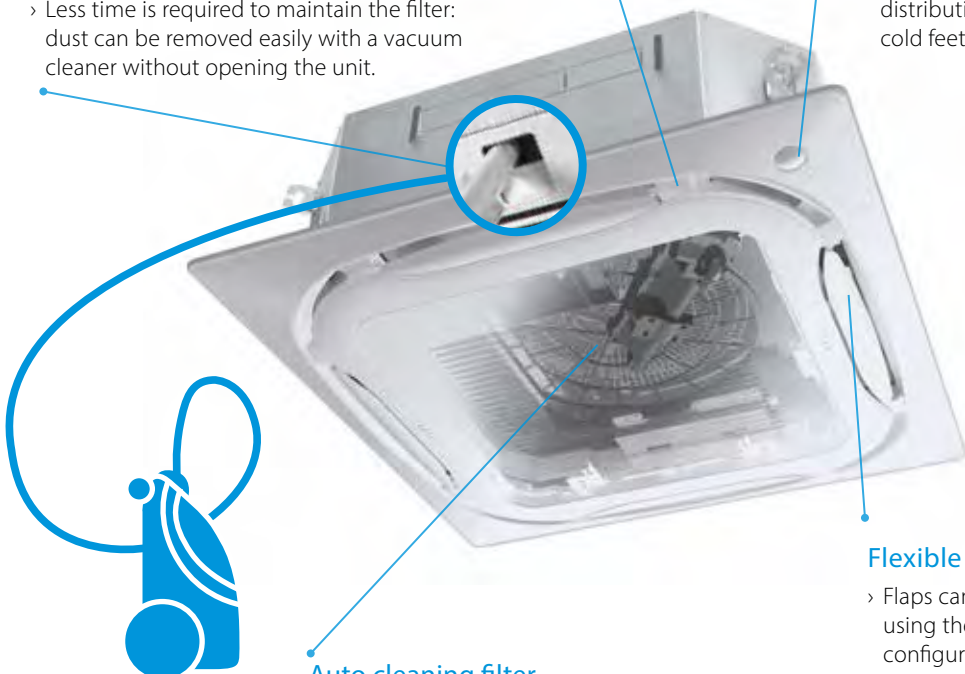

Auto cleaning filter

## Flexible installation

- › Flaps can be individually controlled or closed using the wired remote control, to suit room configuration. Optional closure kits are also available.

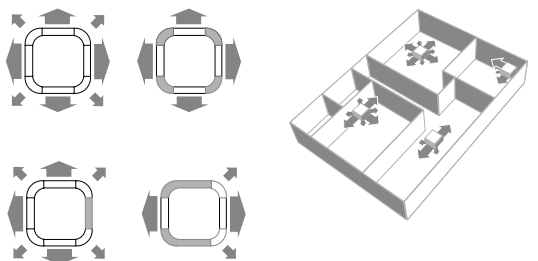

Dust can simply be removed using a vacuum cleaner without opening the unit.

\* Available as an option





**NEW**

# Widest ever range of decoration panels to fit the interior and application

## Standard panels available in white and black

- › The unique Daikin round flow cassette with 360° air flow, wide flaps and optional intelligent sensors



BYCQ140E  
white standard panel



BYCQ140EW  
Full white standard panel



BYCQ140EB  
black standard panel

## Auto cleaning panels available in white and black

- › The unique Daikin auto cleaning cassette with wide flaps and optional intelligent sensors
- › Finer mesh panel for dust prone areas (i.e. clothing and book shops)



BYCQ140EG  
White auto cleaning panel



BYCQ140EG(F)  
White auto cleaning panel  
with fine dust filter



BYCQ140EGFB  
Black auto cleaning panel  
with fine dust filter

## Designer panel in white and black

- › New line of design panels hiding air intake grilles for a more stylized outlook
- › With 360° air flow, wide flaps and optional intelligent sensors



White BYCQ140EP  
White designer panel panel



BYCQ140EPB  
Black designer panel



ROUND FLOW CASSETTE, BLACK DESIGNER PANEL

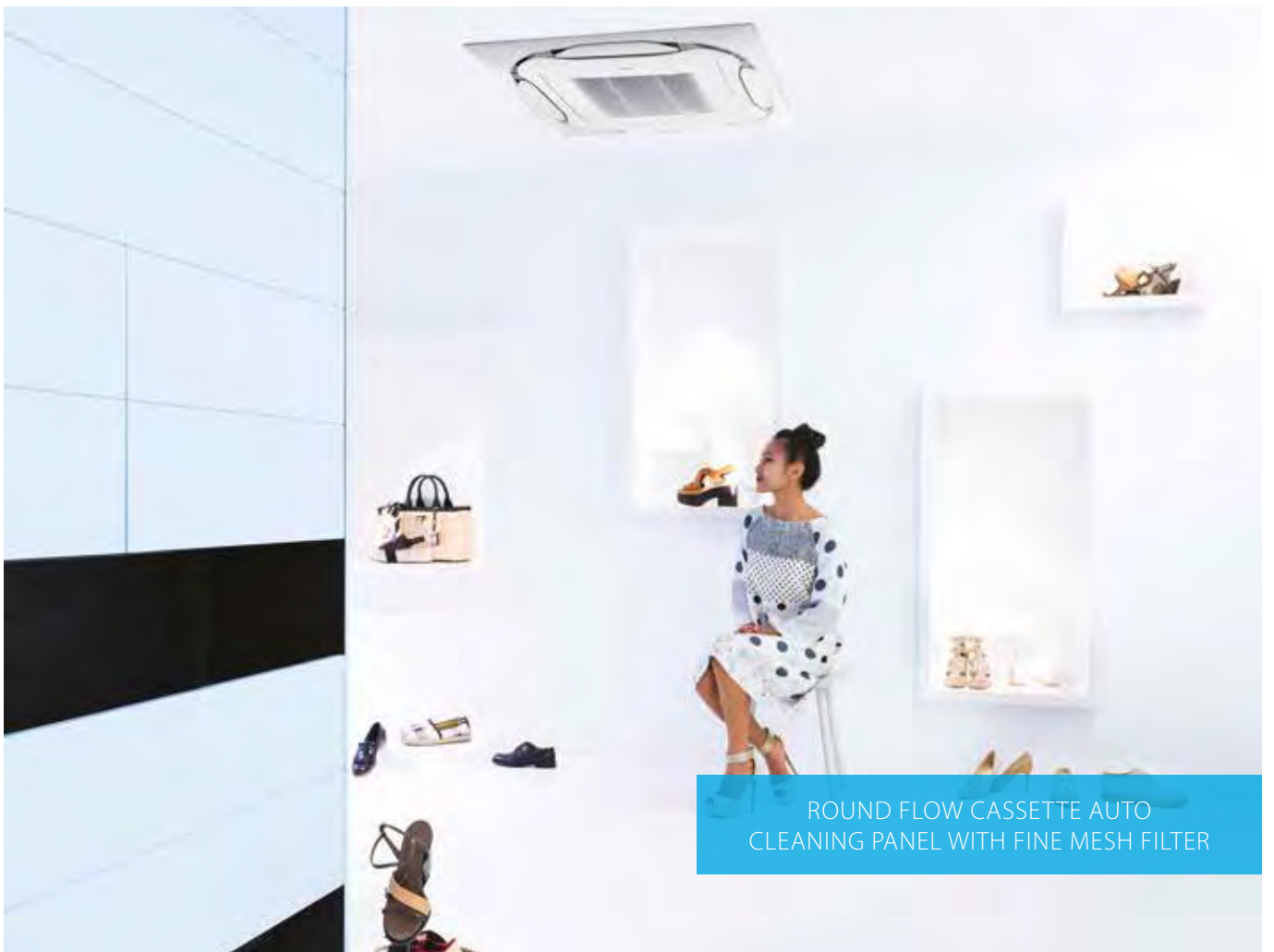

ROUND FLOW CASSETTE AUTO  
CLEANING PANEL WITH FINE MESH FILTER



# Round flow cassette

360° air discharge for optimum efficiency and comfort

- › Automatic filter cleaning results in higher efficiency & comfort and lower maintenance costs. 2 filters available: standard filter and finer mesh filter (for fine dust applications e.g. clothing shops)
- › Two optional intelligent sensors improve energy efficiency and comfort
- NEW** › Widest choice ever in decoration panels: Designer, standard and autocleaning panels in white (RAL9010) and black (RAL9005)
- NEW** › Bigger flaps improve equal air distribution
- › Individual flap control: flexibility to suit every room layout without changing the location of the unit!
- › Lowest installation height in the market: 214mm for class 20-63
- › Optional fresh air intake
- › Branch duct discharge allows to optimize air distribution in irregular shaped rooms or to supply air to small adjacent rooms

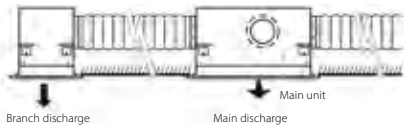

- › Standard drain pump with 675mm lift increases flexibility and installation speed

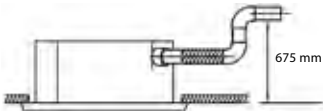

Access all technical information on FXFQ-B at [my.daikin.eu](http://my.daikin.eu) or click here

Indoor unit			FXFQ	20B	25B	32B	40B	50B	63B	80B	100B	125B					
Cooling capacity	Total capacity	Nom.	kW	2.20	2.80	3.60	4.50	5.60	7.10	9.00	11.20	14.00					
Heating capacity	Total capacity	Nom.	kW	2.5	3.2	4.0	5.0	6.3	8.0	10.0	12.5	16.0					
Power input - 50Hz	Cooling	Nom.	kW	0.04			0.05		0.06	0.09	0.12	0.19					
	Heating	Nom.	kW	0.04			0.05		0.06	0.09	0.11	0.18					
Dimensions	Unit	HeightxWidthxDepth	mm	204x840x840						246x840x840		288x840x840					
Weight	Unit		kg	19		20			21		24		26				
Casing	Material			Galvanised steel plate													
Decoration panel	Model			Standard panels: BYCQ140E - white with grey louvers / BYCQ140EW - full white / BYCQ140EB - black Auto cleaning panels: BYCQ140EGF - white / BYCQ140EGFB - black Designer panels: BYCQ140EP - white / BYCQ140EPB - black													
	Dimensions	HeightxWidthxDepth	mm	Standard panels: 50x950x950 / Auto cleaning panels: 130x950x950 / Designer panels: 50x950x950													
Fan	Air flow rate - 50Hz	Cooling	Low/High	m <sup>3</sup> /min	8.8/12.5		9.5/13.6		10.5/15.0		12.4/22.8		12.4/26.5		19.9/33.0		
		Heating	Low/High	m <sup>3</sup> /min	8.8/12.5		9.5/13.6		10.5/15.0		10.5/16.5		12.4/22.8		12.4/26.5		19.9/33.0
Air filter	Type			Resin net													
Sound power level	Cooling	High	dB(A)	49			51			53		55		60		61	
	Heating	Low/Nom./High	dB(A)	28.0/29.0/31.0			29.0/31.0/33.0			30.0/33.0/35.0		30.0/34.0/38.0		30.0/37.0/43.0		36.0/41.0/45.0	
Sound pressure level	Cooling	Low/Nom./High	dB(A)	28.0/29.0/31.0			29.0/31.0/33.0			30.0/33.0/35.0		30.0/34.0/38.0		30.0/37.0/43.0		36.0/41.0/45.0	
	Heating	Low/Nom./High	dB(A)	28.0/29.0/31.0			29.0/31.0/33.0			30.0/33.0/35.0		30.0/34.0/38.0		30.0/37.0/43.0		36.0/41.0/45.0	
Refrigerant	Type/GWP			R-410A/2,087.5													
Piping connections	Liquid	OD	mm	6.35						9.52							
	Gas	OD	mm	12.70						15.90							
	Drain			VP25 (O.D. 32 / I.D. 25)													
Power supply	Phase/Frequency/Voltage		Hz/V	1~/50/60/220-240/220													
Current - 50Hz	Maximum fuse amps (MFA)		A	16													
Control systems	Infrared remote control			BRC7FA532F													
	Wired remote control			BRC1H519W/S/K / BRC1E53A/B/C / BRC1D52													

(1) MFA is used to select the circuit breaker and the ground fault circuit interrupter (earth leakage circuit breaker). For more detailed information on each combination, please refer to the electrical data drawing.

# Fully Flat Cassette

Design & Genius in one

## Why choose fully flat cassette

- Unique design in the market that integrates fully flat into the ceiling
- Advanced technology and top efficiency combined
- Most quiet cassette available on the market

## FXZQ-A



Choice between grey or white panel



## Benefits for the installer

- > Unique product in the market!
- > Most quiet unit (25dBA)
- > The user-friendly remote control, available in several languages, enables the easy set-up of sensor option and control of the individual flap position
- > Meeting European design taste.

## Benefits for the consultant

- > Unique product in the market!
- > Blends seamlessly in any modern office interior design
- > Ideal product to improve BREEAM score/EPBD in combination with Sky Air (FFA-A) or VRV IV heat pump units (FXZQ-A).

## Benefits for the end user

- > Engineering excellence and unique design in one
- > Most quiet unit (25dBA)
- > Perfect working conditions: no more cold draughts
- > Save up to 27% on your energy bill thanks to the optional sensors
- > Flexible usage of space and suits any room configuration thanks to individual flap control
- > User-friendly remote control, available in several languages.

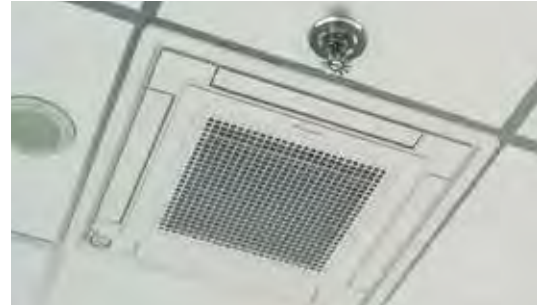

### Unique design

- › Designed by a European design office to fully meet the European taste.
- › Fully flat into the ceiling, leaving only 8mm.
- › Fully integrated in the one ceiling tile, enabling lights, speakers and sprinklers to be installed in adjoining ceiling tiles.
- › Decoration panel available in 2 colours (white and white-silver).



### Differentiating in technology

#### Optional presence sensor

- › When the room is empty, it can adjust the set temperature or switch off the unit – saving energy.
- › When people are detected, the direction of the airflow is adapted to avoid cold draughts being directed towards occupants.

#### Optional floor sensor

- › Detects the temperature difference and re-directs the airflow to ensure even temperature distribution.

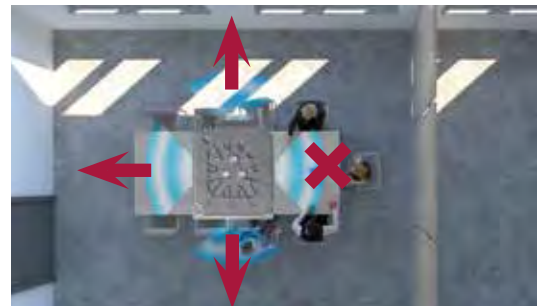
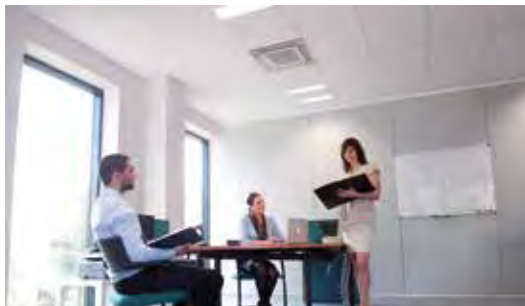

### Top efficiency

- › When the room is empty, the sensor option can adjust the set temperature or switch off the unit – saving up to 27% energy.

### Other benefits

- › Individual flap control: easily control one or more flaps via the wired remote controller (BRC1E/ BRC1H) when rearranging the room. When fully closing or blocking the flaps, the option "Sealing member of air discharge outlet" is needed.
- › Most silent cassette in the market (25dBA), important for office applications.



### Marketing tools

- › [https://www.daikin.eu/en\\_us/product-group/fully-flat-cassette.html](https://www.daikin.eu/en_us/product-group/fully-flat-cassette.html)
- › [www.youtube.com/DaikinEurope](https://www.youtube.com/DaikinEurope)





# Fully flat cassette

Unique design in the market that integrates fully flat into the ceiling

- › Fully flat integration in standard architectural ceiling tiles, leaving only 8mm
- › Remarkable blend of iconic design and engineering excellence with an elegant finish in white or a combination of silver and white
- › Two optional intelligent sensors improve energy efficiency and comfort
- › 15 class unit especially developed for small or well-insulated rooms, such as hotel bedrooms, small offices, etc.
- › Individual flap control: flexibility to suit every room layout without changing the location of the unit!

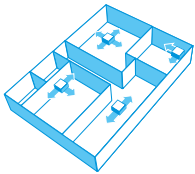

- › Optional fresh air intake
- › Standard drain pump with 630mm lift increases flexibility and installation speed

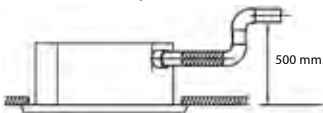

Access all technical information on FXZQ-A at [my.daikin.eu](http://my.daikin.eu) or click here

Indoor unit			FXZQ	15A	20A	25A	32A	40A	50A	
Cooling capacity	Total capacity	Nom.	kW	1.70	2.20	2.80	3.60	4.50	5.60	
	Heating capacity	Total capacity	Nom.	1.90	2.50	3.20	4.00	5.00	6.30	
Power input - 50Hz	Cooling	Nom.	kW		0.043		0.045	0.059	0.092	
	Heating	Nom.	kW		0.036		0.038	0.053	0.086	
Dimensions	Unit	HeightxWidthxDepth	mm	260x575x575						
Weight	Unit		kg	15.5		16.5		18.5		
Casing	Material			Galvanised steel plate						
	Model			BYFQ60C2W1W						
Decoration panel	Colour			White (N9.5)						
	Dimensions	HeightxWidthxDepth	mm	46x620x620						
	Weight		kg	2.8						
	Model			BYFQ60C2W1S						
Decoration panel 2	Colour			SILVER						
	Dimensions	HeightxWidthxDepth	mm	46x620x620						
	Weight		kg	2.8						
	Model			BYFQ60B2W1						
Decoration panel 3	Colour			White (RAL9010)						
	Dimensions	HeightxWidthxDepth	mm	55x700x700						
	Weight		kg	2.7						
	Model			BYFQ60B3W1						
Decoration panel 4	Colour			WHITE (RAL9010)						
	Dimensions	HeightxWidthxDepth	mm	55x700x700						
	Weight		kg	2.7						
	Model									
Fan	Air flow rate - 50Hz	Cooling	Low/High	m <sup>3</sup> /min	6.5/8.5	6.5/8.7	6.5/9.0	7.0/10.0	8.0/11.5	10.0/14.5
		Heating	Low/High	m <sup>3</sup> /min	6.5/8.5	6.5/8.7	6.5/9.0	7.0/10.0	8.0/11.5	10.0/14.5
Air filter	Type			Resin net						
Sound power level	Cooling	High	dBA	49		50	51	54	60	
		Low/Nom./High	dBA	25.5/28.0/31.5	25.5/29.5/32.0	25.5/30.0/33.0	26.0/30.0/33.5	28.0/32.0/37.0	33.0/40.0/43.0	
Sound pressure level	Heating	Low/Nom./High	dBA	25.5/28.0/31.5	25.5/29.5/32.0	25.5/30.0/33.0	26.0/30.0/33.5	28.0/32.0/37.0	33.0/40.0/43.0	
				R-410A/2,087.5						
Refrigerant	Type/GWP									
	Piping connections	Liquid	OD	mm	6.35					
		Gas	OD	mm	12.7					
	Drain			VP20 (I.D. 20/O.D. 26)						
Power supply	Phase/Frequency/Voltage		Hz/V	1~/50/60/220-240/220						
Current - 50Hz	Maximum fuse amps (MFA)		A	16						
Control systems	Infrared remote control			BRC7E530W (standard panel) / BRC7F530W (white panel) / BRC7F530S (grey panel)						
	Wired remote control			BRC1H519W/S/K / BRC1E53A/B/C / BRC1D52						

Dimensions do not include control box

# 2-way blow ceiling mounted cassette

Thin, lightweight design installs easily in narrow corridors

- › Depth of all units is 620mm, ideal for narrow spaces
- › Individual flap control: flexibility to suit every room layout without changing the location of the unit!

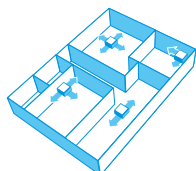

- › Stylish unit blends easily with any interior. The flaps close entirely when the unit is not operating and there are no air intake grilles visible
- › Fresh air intake integrated in the same system thus reducing installation cost as no additional ventilation device is required

Fresh air intake opening in casing



\* Brings in up to 10% of fresh air into the room

- › Optimum comfort guaranteed with automatic air flow adjustment to the required load
- › Maintenance operations can be performed by removing the front panel



- › Branch duct discharge allows to optimize air distribution in irregular shaped rooms or to supply air to small adjacent rooms

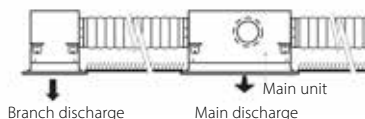

- › Standard drain pump with 580mm lift increases flexibility and installation speed

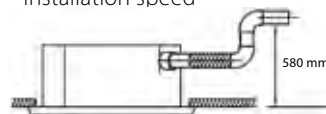

Access all technical information on FXCQ-A at [my.daikin.eu](http://my.daikin.eu) or click here

Indoor unit		FXCQ		20A	25A	32A	40A	50A	63A	80A	125A								
Cooling capacity	Total capacity	Nom.	kW	2.2	2.8	3.6	4.5	5.6	7.1	9.0	14.0								
	Heating capacity	Total capacity	Nom.	kW	2.5	3.2	4.0	5.0	6.3	8.0	10.0								
Power input - 50Hz	Cooling	Nom.	kW	0.031	0.039		0.041	0.059	0.063	0.090	0.149								
	Heating	Nom.	kW	0.028	0.035		0.037	0.056	0.060	0.086	0.146								
Dimensions	Unit	HeightxWidthxDepth		305x775x620				305x990x620		305x1,445x620									
Weight	Unit			19				22	25	33	38								
Casing	Material		Galvanised steel plate																
Decoration panel	Model	BYBCQ40HW1				BYBCQ63HW1			BYBCQ125HW1										
	Colour	Fresh white (6.5Y 9.5/0.5)																	
Fan	Dimensions	HeightxWidthxDepth		55x1,070x700				55x1,285x700		55x1,740x700									
	Weight			10				11		13									
Air filter	Air flow rate - 50Hz	Cooling	Low/High	7.5/10.5		8/11.5		8.5/12	10.5/15	11.5/16	18.5/26	22.5/32							
	Type	Resin net with mold resistance																	
Sound power level	Cooling	Nom./High		46/48		47/50		48/50		49/52		51/53		53/55		54/58		58/62	
	Sound pressure level	Cooling	Low/Nom./High		28.0/30.0/32.0		29.0/31.0/34.0		30.0/32.0/34.0		31.0/33.0/36.0		31.0/35.0/37.0		32.0/37.0/39.0		33.0/38.0/42.0		38.0/42.0/46.0
Refrigerant	Heating	Low/Nom./High		28.0/30.0/32.0		29.0/31.0/34.0		30.0/32.0/34.0		31.0/33.0/36.0		31.0/35.0/37.0		32.0/37.0/39.0		33.0/38.0/42.0		38.0/42.0/46.0	
	Type/GWP	R-410A/2,087.5																	
Piping connections	Liquid	OD	mm		6.35				9.52										
	Gas	OD	mm		12.7				15.9										
	Drain	VP25 (O.D. 32 / I.D. 25)																	
Power supply	Phase/Frequency/Voltage		Hz/V		1~/50/220-240														
Current - 50Hz	Maximum fuse amps (MFA)		A		16														
Control systems	Infrared remote control		BRC7C52																
	Wired remote control		BRC1H519W/S/K / BRC1E53A/B/C / BRC1D52																



# Ceiling mounted corner cassette

## 1-way blow unit for corner installation

- › Compact dimensions, can easily be mounted in a narrow ceiling void (only 220mm ceiling space required, 195 with panel spacer, available as accessory)
- › Optimum air flow conditions are created by either downward air discharge or frontal air discharge (via optional grille) or a combination of both

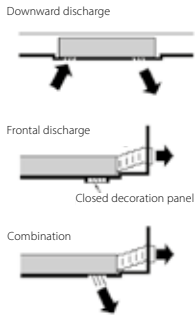

- › Maintenance operations can be performed by removing the front panel
- › Standard drain pump with 330mm lift increases flexibility and installation speed

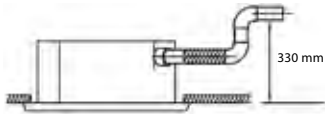

Access all technical information on FXKQ-MA at [my.daikin.eu](http://my.daikin.eu) or [click here](#)

Indoor unit				FXKQ	25MA	32MA	40MA	63MA
Cooling capacity	Total capacity	Nom.		kW	2.8	3.6	4.5	7.10
Heating capacity	Total capacity	Nom.		kW	3.2	4.0	5.0	8.00
Power input - 50Hz	Cooling	Nom.		kW	0.066		0.076	0.105
	Heating	Nom.		kW	0.046		0.056	0.085
Dimensions	Unit	HeightxWidthxDepth		mm	215x1,110x710			215x1,310x710
Weight	Unit			kg	31			34
Casing	Material				Galvanised steel plate			
Decoration panel	Model				BYK45FJW1			BYK71FJW1
	Colour				White			
	Dimensions	HeightxWidthxDepth		mm	70x1,240x800			70x1,440x800
	Weight			kg	8.5			9.5
Fan	Air flow rate - 50Hz	Cooling	Low/High	m <sup>3</sup> /min	9/11		10/13	15/18
Air filter	Type				Resin net with mold resistance			
Sound power level	Cooling	High		dB(A)	54		56	58
	Cooling	Low/High		dB(A)	33.0/38.0		34.0/40.0	37.0/42.0
Refrigerant	Type/GWP				R-410A/2,087.5			
Piping connections	Liquid	OD		mm	6.35			9.52
	Gas	OD		mm	12.7			15.9
	Drain				VP25 (O.D. 32 / I.D. 25)			
Power supply	Phase/Frequency/Voltage			Hz/V	1~/50/60/220-240/220			
Current - 50Hz	Maximum fuse amps (MFA)			A	15			
Control systems	Infrared remote control				BRC4C61			
	Wired remote control				BRC1H519W/S/K / BRC1E53A/B/C / BRC1D52			

# Auto cleaning filter for concealed ceiling units

The unique automatic cleaning filter achieves higher efficiency and comfort with lower maintenance costs

### Reduce running costs

- › Automatic filter cleaning ensures low maintenance costs because the filter is always clean

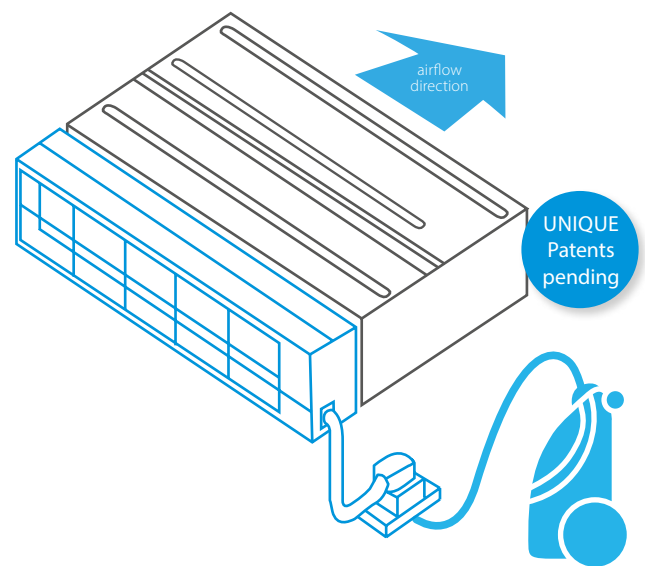
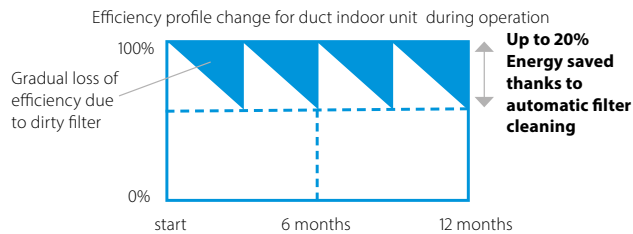

### Minimal time required for filter cleaning

- › The dust box can be emptied with a vacuum cleaner for fast and easy cleaning
- › No more dirty ceilings

### Improved indoor air quality

- › Optimum airflow eliminates draft and insulates sound

### Superb reliability

- › Prevents clogged filters for seamless operation

### Unique technology

- › Unique and innovative filter technology inspired by the Daikin auto cleaning cassette



## How does it work?

- 1 Scheduled automatic filter cleaning
- 2 Dust collects in a dust box that's integrated into the unit
- 3 The dust can easily be removed with a vacuum cleaner



[www.youtube.com/DaikinEurope](http://www.youtube.com/DaikinEurope)



### Combination table

	Split / Sky Air				VRV						
	FDXM-F9				FXDQ-A3						
	25	35	50	60	15	20	25	32	40	50	63
BAE20A62	•	•			•	•	•	•			
BAE20A82									•	•	
BAE20A102			•	•							•

### Specifications

	BAE20A62	BAE20A82	BAE20A102
Height (mm)	210		
Width (mm)	830	1,030	1,230
Depth (mm)	188		

# Multi zoning kit for concealed ceiling units

The multi-zoning system is a room-by-room controller. It is fitted with motorised dampers, which immediately adapt using Daikin ducted solutions. This system supports control of up to 8 zones via a centralised thermostat located in the main room and individual thermostats for each of the zones.

## Benefits

### Increased comfort

- › Increases comfort levels by allowing more individual zone control
  - Up to 8 individual zones can be served thanks to separate modulating dampers
  - Individual thermostat for room-by-room or zone-by-zone control

### Easy to install

- › Automatic air flow adjustment according to the demand
- › Easy to install, integrates with the Daikin indoor units and system controls
- › Time saving as plenum comes fully pre-assembled with dampers, and control boards
- › Reduces the amount of refrigerant required in the installation

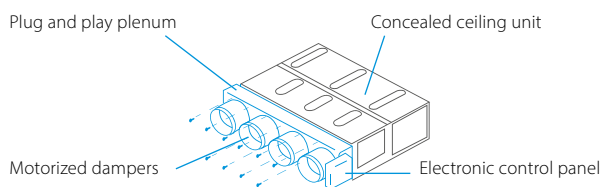

## How does it work?

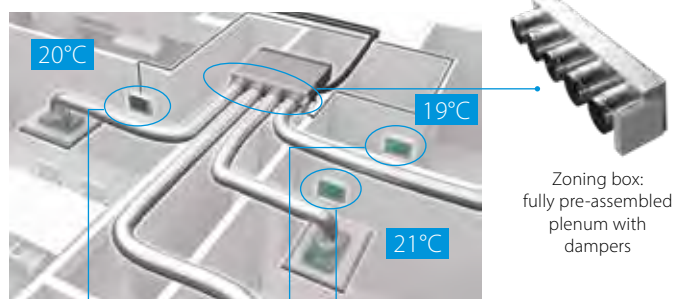

### Individual zone thermostats

#### Blueface - Airzone Main Thermostat

- › Color graphic interface for controlling zones
- › Wired communication



AZCE6BLUEFACECB

#### Airzone Zone Thermostat

- › Graphic interface with low-energy e-ink screen for controlling zones
- › Radio communication



AZCE6THINKRB

#### Airzone Zone Thermostat

- › Thermostat with buttons for controlling the temperature
- › Radio communication



AZCE6LITERB

## Compatibility

			SkyAir												VRV																							
			FDXM-F9				FBA-A9				ADEA-A				FXDQ-A3						FXSQ-A																	
Number of motorised dampers	Reference	Dimensions H x W x D (mm)	25	35	50	60	35	50	60	71	100	125	140	71	100	125	15	20	25	32	40	50	63	15	20	25	32	40	50	63	71	80	100	125	140			
Standard Ceiling Void	2	AZEZ6DAIST07XS2																																				
		AZEZ6DAIST07S2																																				
		AZEZ6DAIST07XS3																																				
	3	AZEZ6DAIST07S3																																				
		AZEZ6DAIST07S4																																				
		AZEZ6DAIST07M4																																				
	4	AZEZ6DAIST07M5																																				
		AZEZ6DAIST07L5																																				
Compact Ceiling Void	6	AZEZ6DAIST07M6																																				
		AZEZ6DAIST07L6																																				
	7	AZEZ6DAIST07L7																																				
		AZEZ6DAIST07XL7																																				
	8	AZEZ6DAIST07L8																																				
		AZEZ6DAIST07XL8																																				
	2	AZEZ6DAISL01S2																																				
	3	AZEZ6DAISL01S3																																				
4	AZEZ6DAISL01M4																																					
5	AZEZ6DAISL01L5																																					

# Slim concealed ceiling unit

## Slim design for flexible installation

- › Compact dimensions, can easily be mounted in a ceiling void of only 240mm

SERIE A (15, 20, 25, 32)

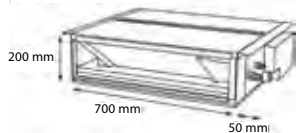

- › Medium external static pressure up to 44Pa facilitates unit use with flexible ducts of varying lengths
- › Discretely concealed in the wall: only the suction and discharge grilles are visible
- › 15 class unit especially developed for small or well-insulated rooms, such as hotel bedrooms, small offices, etc.
- › Auto cleaning filter option ensures maximum efficiency, comfort and reliability by regular filter cleaning
- › Multi zoning kit allows multiple individually-controlled climate zones to be served by one indoor unit
- › Flexible installation, as the air suction direction can be altered from rear to bottom suction

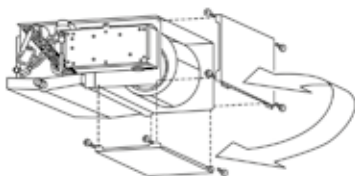

- › Standard drain pump with 750mm lift increases flexibility and installation speed

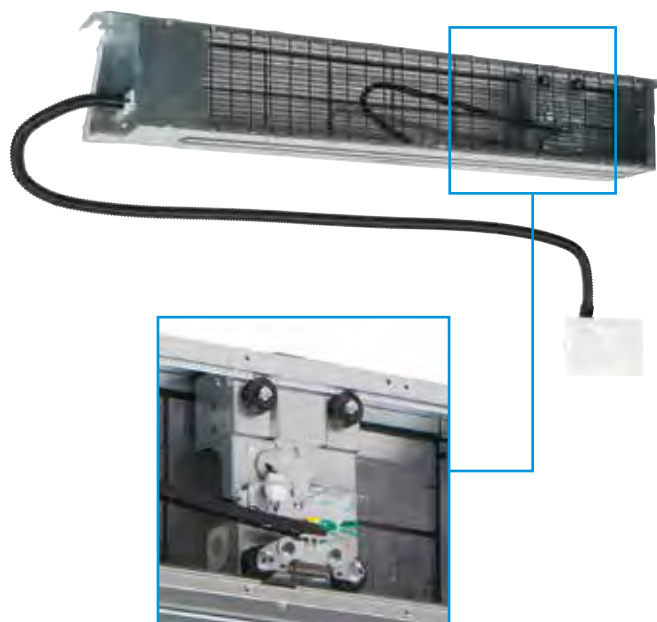
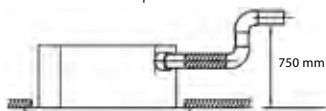

Auto cleaning filter option



Access all technical information on FXDQ-A3 at [my.daikin.eu](http://my.daikin.eu) or click here



Access all technical information on BAE20A at [my.daikin.eu](http://my.daikin.eu) or click here

Indoor unit			FXDQ	15A3	20A3	25A3	32A3	40A3	50A3	63A3
Cooling capacity	Total capacity	Nom.	kW	1.70	2.20	2.80	3.60	4.50	5.60	7.10
Heating capacity	Total capacity	Nom.	kW	1.90	2.50	3.20	4.00	5.00	6.30	8.00
Power input - 50Hz	Cooling	Nom.	kW	0.071			0.078		0.099	0.110
	Heating	Nom.	kW	0.068			0.075		0.096	0.107
Required ceiling void >			mm	240						
Dimensions	Unit	HeightxWidthxDepth	mm	200x750x620			200x950x620		200x1,150x620	
Weight	Unit		kg	22.0			26.0		29.0	
Casing	Material			Galvanised steel						
Fan	Air flow rate - 50Hz	Cooling	Low/High	m <sup>3</sup> /min	6.4/7.5	6.4/8.0		8.5/10.5	10.0/12.5	13.0/16.5
	External static pressure - 50Hz	Nom./High		Pa	10/30.0			15/44.0		
Air filter	Type			Removable / washable						
Sound power level	Cooling	High	dBA	50	51		52	53	54	
Sound pressure level	Cooling	Low/Nom./High	dBA	27.0/31.0/32.0	27.0/31.0/33.0		28.0/32.0/34.0	29.0/33.0/35.0	30.0/34.0/36.0	
Refrigerant	Type/GWP			R-410A/2,087.5						
Piping connections	Liquid	OD	mm	6.35			9.52			
	Gas	OD	mm	12.7			15.9			
	Drain			VP20 (I.D. 20/O.D. 26)						
Power supply	Phase/Frequency/Voltage		Hz/V	1~/50/60/220-240/220						
Current - 50Hz	Maximum fuse amps (MFA)		A	16						
Control systems	Infrared remote control			BRC4C65 / BRC4C66						
	Wired remote control			BRC1H519W/S/K / BRC1E53A/B/C / BRC1D52						

# Concealed ceiling unit with medium ESP

Slimmest yet most powerful medium static pressure unit on the market

- > Slimmest unit in class, only 245mm (300mm built-in height) and therefore narrow ceiling voids are no longer a challenge



- > Quiet operation: down to 25dBA sound pressure level
- > Medium external static pressure up to 150Pa facilitates using flexible ducts of varying lengths
- > Possibility to change ESP via wired remote control allows optimisation of the supply air volume
- > Discretely concealed in the wall: only the suction and discharge grilles are visible
- > 15 class unit especially developed for small or well-insulated rooms, such as hotel bedrooms, small offices, etc.
- > Multi zoning kit allows multiple individually-controlled climate zones to be served by one indoor unit
- > Optional fresh air intake
- > Flexible installation: air suction direction can be altered from rear to bottom suction and choice between free use or connection to optional suction grilles

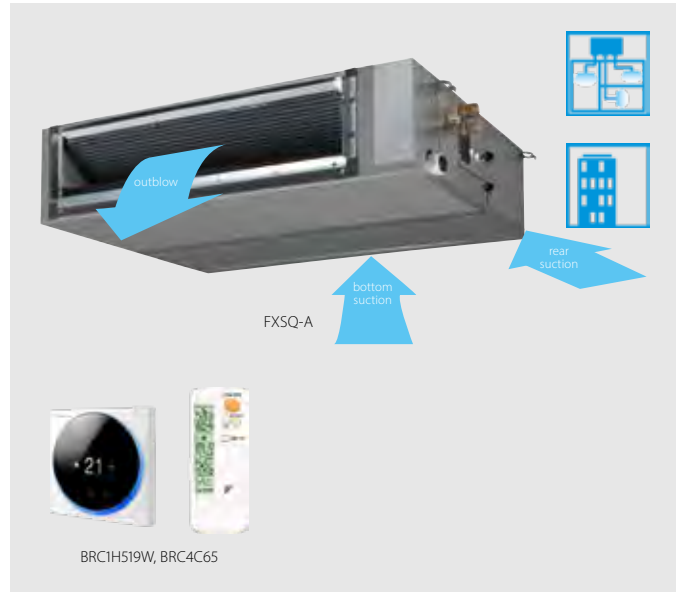

- > Standard built-in drain pump with 625mm lift increases flexibility and installation speed

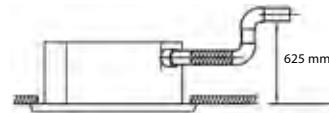

## Automatic Airflow Adjustment function

Automatically selects the most appropriate fan curve to achieve the units' nominal air flow within ±10%

### Why?

After installation the real ducting will frequently differ from the initially calculated air flow resistance \* the real air flow may be much lower or higher than nominal, leading to a lack of capacity or uncomfortable air temperature. Automatic Airflow Adjustment function will adapt the unit's fan speed to any ducting automatically (10 or more fan curves are available on every model), making installation much faster.

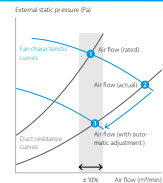

Access all technical information on FXSQ-A at [my.daikin.eu](http://my.daikin.eu) or click here

Indoor unit			FXSQ	15A	20A	25A	32A	40A	50A	63A	80A	100A	125A	140A
Cooling capacity	Total capacity	Nom.	kW	1.70	2.20	2.80	3.60	4.50	5.60	7.10	9.00	11.20	14.00	16.00
Heating capacity	Total capacity	Nom.	kW	1.90	2.50	3.20	4.00	5.00	6.30	8.00	10.0	12.5	16.0	18.0
Power input - 50Hz	Cooling	Nom.	kW	0.090			0.096	0.151	0.154	0.188	0.213	0.290	0.331	0.386
	Heating	Nom.	kW	0.086			0.092	0.147	0.150	0.183	0.209	0.285	0.326	0.382
Dimensions	Unit	HeightxWidthxDepth	mm	245x550x800			245x700x800			245x1,000x800			245x1,550x800	
Weight	Unit		kg	23.5			24.0	28.5	29.0	35.5	36.5	46.0	47.0	51.0
Casing	Material			Galvanised steel plate										
Fan	Air flow rate - 50Hz	Cooling	Low/High	m³/min	6.5/8.7	6.5/9.0	7.0/9.5	11.0/15.0	11.0/15.2	15.0/21.0	16.0/23.0	23.0/32.0	26.0/36.0	28.0/39.0
		Heating	Low/High	m³/min	6.5/8.7	6.5/9.0	7.0/9.5	11.0/15.0	11.0/15.2	15.0/21.0	16.0/23.0	23.0/32.0	26.0/36.0	28.0/39.0
	External static pressure - 50Hz	Nom./High	Pa				30/150				40/150	50/150		
Air filter	Type			Resin net										
Sound power level	Cooling	High	dBA	54			55	60	59	61	64			
	Heating	Low/Nom./High	dBA	25.0/28.0/29.5	25.0/28.0/30.0	26.0/29.0/31.0	29.0/32.0/35.0	27.0/30.0/33.0	29.0/32.0/35.0	31.0/34.0/36.0	33.0/36.0/39.0	34.0/38.0/41.5		
Refrigerant	Type/GWP			R-410A/2,087.5										
	Piping connections	Liquid OD	mm	6.35			9.52			15.9				
Power supply	Phase/Frequency/Voltage	Hz/V		VP20 (I.D. 20/O.D. 26), drain height 625 mm										
	Current - 50Hz	Maximum fuse amps (MFA)	A	1~/50/60/220-240/220										
Control systems	Infrared remote control			BRC4C65										
	Wired remote control			BRC1H519W/S/K / BRC1E53A/B/C / BRC1D52										

# Concealed ceiling unit with high ESP

Ideal for large sized spaces  
 FXMQ-P7: ESP up to 200 Pa

- › Possibility to change ESP via wired remote control allows optimisation of the supply air volume
- › High external static pressure up to 200Pa facilitates extensive duct and grille network
- › Discretely concealed in the wall: only the suction and discharge grilles are visible
- › Fresh air intake integrated in the same system thus reducing installation cost as no additional ventilation device is required

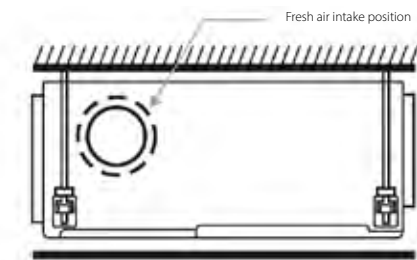

\* Brings in up to 10% of fresh air into the room

- › Flexible installation, as the air suction direction can be altered from rear to bottom suction

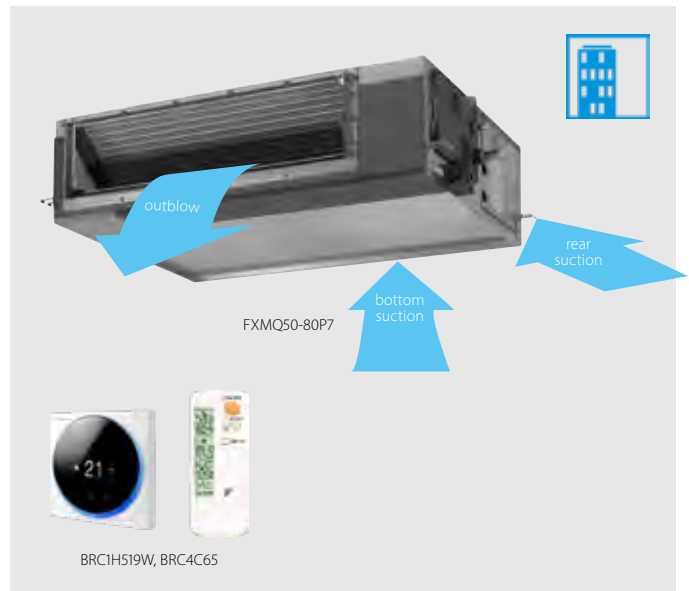
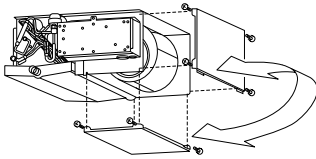

- › Standard built-in drain pump with 625mm lift increases flexibility and installation speed

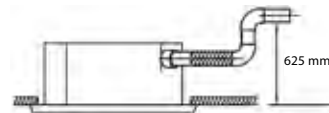

FXMQ-MB: ESP up to 270 Pa

- › High external static pressure up to 270Pa facilitates extensive duct and grille network
- › Discretely concealed in the wall: only the suction and discharge grilles are visible
- › Large capacity unit: up to 31.5 kW heating capacity

## Automatic Airflow Adjustment function

Automatically selects the most appropriate fan curve to achieve the units' nominal air flow within ±10%

### Why?

After installation the real ducting will frequently differ from the initially calculated air flow resistance \* the real air flow may be much lower or higher than nominal, leading to a lack of capacity or uncomfortable air temperature. Automatic Airflow Adjustment function will adapt the unit's fan speed to any ducting automatically (10 or more fan curves are available on every model), making installation much faster.

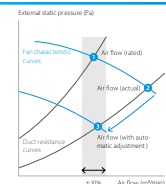

 Access all technical information on FXMQ-P7 at [my.daikin.eu](http://my.daikin.eu) or click here

 Access all technical information on FXMQ-MB at [my.daikin.eu](http://my.daikin.eu) or click here

Indoor unit			FXMQ	50P7	63P7	80P7	100P7	125P7	200MB	250MB	
Cooling capacity	Total capacity	Nom.	kW	5.6	7.1	9.0	11.2	14.0	22.4	28.0	
			kW				-				
Heating capacity	Total capacity	Nom.	kW	6.3	8.0	10.0	12.5	16.0	25.0	31.5	
			kW				-				
Power input - 50Hz	Cooling	Nom.	kW	0.110	0.120	0.171	0.176	0.241	0.895	1.185	
	Heating	Nom.	kW	0.098	0.108	0.159	0.164	0.229	0.895	1.185	
Required ceiling void >			mm	350							
Dimensions	Unit	HeightxWidthxDepth	mm	300x1,000x700			300x1,400x700		470x1,380x1,100		
Weight	Unit		kg	35			46		132		
Casing	Material			Galvanised steel plate							
Decoration panel	Model			BYB571DJW1			BYB5125DJW1				
	Colour			White (10Y9/0.5)							
	Dimensions	HeightxWidthxDepth	mm	55x1,100x500			55x1,500x500		-x-x-		
	Weight		kg	4.5			6.5				
Fan	Air flow rate - 50Hz	Cooling	Low/High	m <sup>3</sup> /min	15.0/18.0	16.0/19.5	20.0/25.0	23.0/32.0	28.0/39.0	50/58	62/72
		Heating	Low/High	m <sup>3</sup> /min	15.0/18.0	16.0/19.5	20.0/25.0	23.0/32.0	28.0/39.0	-/-	
	External static pressure - 50Hz	Nom./High	Pa	100/200					160/270	170/270	
Air filter	Type			Resin net							
Sound power level	Cooling	Nom./High	dB(A)	-/61	-/64	-/67	-/65	-/70	75/76		
	Heating	Low/High	dB(A)	37/41	38/42	39/43		40/44	45/48		
Sound pressure level	Cooling	Low/High	dB(A)	37/41	38/42	39/43		40/44	-/-		
	Heating	Low/High	dB(A)	37/41	38/42	39/43		40/44	-/-		
Refrigerant	Type/GWP			R-410A/-							
Piping connections	Liquid	OD	mm	6.35		9.52					
	Gas	OD	mm	12.7		15.9		19.1	22.2		
	Drain					VP25 (I.D. 25/O.D. 32)		PS1B			
Power supply	Phase/Frequency/Voltage	Hz/V		1~/50/60/220-240/220							
Current - 50Hz	Maximum fuse amps (MFA)	A		16							
Control systems	Infrared remote control			BRC4C65							
	Wired remote control			BRC1H519W/S/K / BRC1E53A/B/C / BRC1D52							

# Wall mounted unit

For rooms with no false ceilings nor free floor space

- › Flat, stylish front panel blends easily within any interior décor and is easier to clean
- › Can easily be installed in both new and refurbishment projects
- › The air is comfortably spread up- and downwards thanks to 5 different discharge angles that can be programmed via the remote control
- › Maintenance operations can be performed easily from the front of the unit

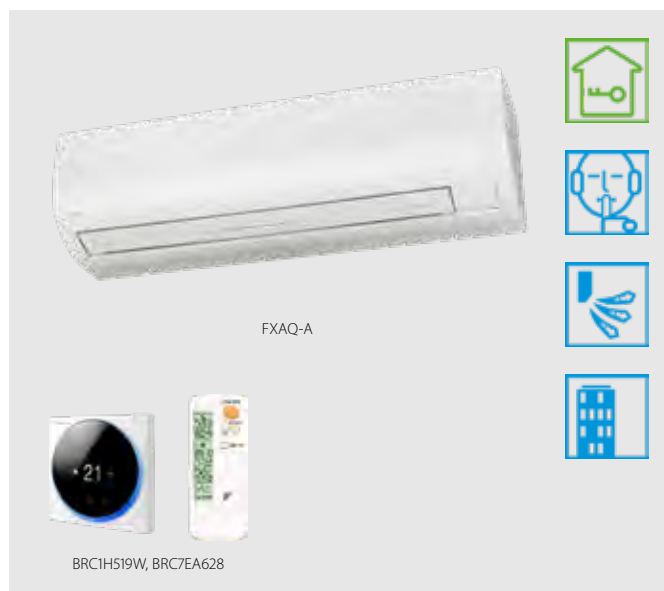

 Access all technical information on FXAQ-A at [my.daikin.eu](http://my.daikin.eu) or click here

Indoor unit			FXAQ	15A	20A	25A	32A	40A	50A	63A	
Cooling capacity	Total capacity	Nom.	kW	1.7	2.2	2.8	3.6	4.5	5.6	7.1	
Heating capacity	Total capacity	Nom.	kW	1.9	2.5	3.2	4.0	5.0	6.3	8.0	
Power input - 50Hz	Cooling	Nom.	kW	0.02		0.03		0.02	0.03	0.05	
	Heating	Nom.	kW	0.03		0.04		0.02	0.04	0.06	
Dimensions	Unit	HeightxWidthxDepth	mm	290x795x266				290x1,050x269			
Weight	Unit		kg	12				15			
Fan	Air flow rate - 50Hz	Cooling	Low/High	m <sup>3</sup> /min	7.0/8.4	7.0/9.1	7.0/9.4	7.0/9.8	9.7/12.2	11.5/14.4	13.5/18.3
		Washable resin net									
Air filter	Type			Washable resin net							
Sound power level	Cooling	High	dB(A)	51.0	52.0	53.0	55.0		58.0	63.0	
Sound pressure level	Cooling	Low/High	dB(A)	28.5/32.0	28.5/33.0	28.5/35.0	28.5/37.5	33.5/37.0	35.5/41.0	38.5/46.5	
	Heating	Low/High	dB(A)	28.5/33.0	28.5/34.0	28.5/36.0	28.5/38.5	33.5/38.0	35.5/42.0	38.5/47.0	
Refrigerant	Type/GWP			R-410A/2,087.5							
Piping connections	Liquid	OD	mm	6.35						9.52	
	Gas	OD	mm	12.7						15.9	
	Drain			VP13 (I.D. 15/O.D. 18)							
Power supply	Phase/Frequency/Voltage		Hz/V	1~/50/220-240							
Current - 50Hz	Maximum fuse amps (MFA)		A	16							
Control systems	Infrared remote control			BRC7EA628 / BRC7EA629							
	Wired remote control			BRC1H519W/S/K / BRC1E53A/B/C / BRC1D52							

# Ceiling suspended unit

For wide rooms with no false ceilings nor free floor space

- › Ideal for comfortable air flow in wide rooms thanks to Coanda effect: up to 100° discharge angle

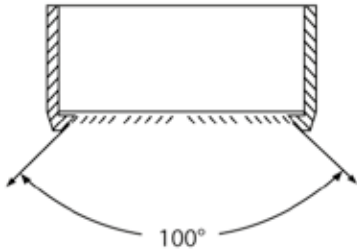

- › Even rooms with ceilings up to 3.8m can be heated up or cooled down very easily without capacity loss
- › Can easily be installed in both new and refurbishment projects
- › Can easily be mounted in corners and narrow spaces, as it only needs 30mm lateral service space

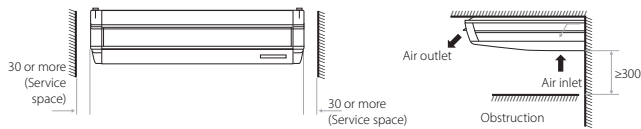

- › Fresh air intake integrated in the same system thus reducing installation cost as no additional ventilation device is required

Fresh air intake opening in casing



\* Brings in up to 10% of fresh air into the room

- › Reduced energy consumption thanks to specially developed DC fan motor and drain pump
- › Stylish unit blends easily with any interior. The flaps close entirely when the unit is not operating and there are no air intake grilles visible



 Access all technical information on FXHQ-A at [my.daikin.eu](http://my.daikin.eu) or click here

Indoor unit			FXHQ	32A	63A	100A	
Cooling capacity	Total capacity	Nom.	kW	3.6	7.1	11.2	
	Heating capacity	Total capacity	Nom.	kW	4.0	8.0	12.5
Power input - 50Hz	Cooling	Nom.	kW	0.107	0.111	0.237	
	Heating	Nom.	kW	0.107	0.111	0.237	
Dimensions	Unit	HeightxWidthxDepth	mm	235x960x690	235x1,270x690	235x1,590x690	
Weight	Unit		kg	24	33	39	
Casing	Material			Resin			
Fan	Air flow rate - 50Hz	Cooling	Low/High	m <sup>3</sup> /min	10.0/14.0	14.0/20.0	19.0/29.5
		Heating	Low/High	m <sup>3</sup> /min	10.0/14.0	14.0/20.0	19.0/29.5
Air filter	Type			Resin net with mold resistance			
Sound power level	Cooling	Nom./High	dB(A)	52/54	53/55	55/62	
Sound pressure level	Cooling	Low/Nom./High	dB(A)	31.0/34.0/36.0	34.0/35.0/37.0	34.0/37.0/44.0	
	Heating	Low/Nom./High	dB(A)	31.0/34.0/36.0	34.0/35.0/37.0	34.0/37.0/44.0	
Refrigerant	Type/GWP			R-410A/2,087.5			
Piping connections	Liquid	OD	mm	6.35		9.52	
	Gas	OD	mm	12.7		15.9	
	Drain				VP20 (I.D. 20/O.D. 26)		
Power supply	Phase/Frequency/Voltage		Hz/V	1~/50/220-240			
Current - 50Hz	Maximum fuse amps (MFA)		A	16			
Control systems	Infrared remote control			BRC7G53			
	Wired remote control			BRC1H519W/S/K / BRC1E53A/B/C / BRC1D52			



# 4-way blow ceiling suspended unit

Unique Daikin unit for high rooms with no false ceilings nor free floor space

- › Even rooms with ceilings up to 3.5m can be heated up or cooled down very easily without capacity loss
- › Can easily be installed in both new and refurbishment projects
- › Individual flap control: flexibility to suit every room layout without changing the location of the unit!

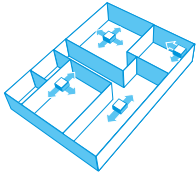

- › Stylish unit blends easily with any interior. The flaps close entirely when the unit is not operating and there are no air intake grilles visible
- › Optimum comfort guaranteed with automatic air flow adjustment to the required load
- › 5 different discharge angles between 0 and 60° can be programmed via the remote control

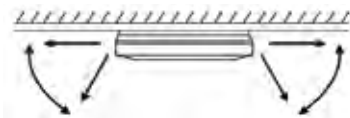

- › Standard drain pump with 500mm lift increases flexibility and installation speed

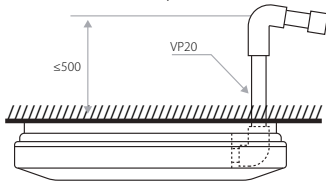

 Access all technical information on FXUQ-A at [my.daikin.eu](http://my.daikin.eu) or click here

Indoor unit			FXUQ	71A	100A
Cooling capacity	Total capacity	Nom.	kW	8.0	11.2
	Heating capacity	Total capacity	Nom.	9.0	12.5
Power input - 50Hz	Cooling	Nom.	kW	0.090	0.200
	Heating	Nom.	kW	0.073	0.179
Dimensions	Unit	HeightxWidthxDepth	mm	198x950x950	
Weight	Unit		kg	26	27
Casing	Material			Resin	
Fan	Air flow rate - 50Hz	Cooling	Low/High	m <sup>3</sup> /min	
		Heating	Low/High	m <sup>3</sup> /min	
Air filter	Type			Resin net with mold resistance	
Sound power level	Cooling	Nom./High	dBA	56/58	62/65
Sound pressure level	Cooling	Low/Nom./High	dBA	36.0/38.0/40.0	40.0/44.0/47.0
	Heating	Low/Nom./High	dBA	36.0/38.0/40.0	40.0/44.0/47.0
Refrigerant	Type/GWP			R-410A/2,087.5	
Piping connections	Liquid	OD	mm	9.52	
	Gas	OD	mm	15.9	
	Drain			I.D. 20/O.D. 26	
Power supply	Phase/Frequency/Voltage		Hz/V	1~/50/60/220-240/220-230	
Current - 50Hz	Maximum fuse amps (MFA)		A	16	
Control systems	Infrared remote control			BRC7C58	
	Wired remote control			BRC1H519W/S/K / BRC1E53A/B/C / BRC1D52	

# Concealed floor standing unit

Designed to be concealed in walls

- › Discretely concealed in the wall: only the suction and discharge grilles are visible
- › Requires very little installation space as the depth is only 200mm



- › Its low height (620 mm) enables the unit to fit perfectly beneath a window
- › High ESP allows flexible installation



Access all technical information on FXNQ-A at [my.daikin.eu](http://my.daikin.eu) or click here

Indoor unit			FXNQ	20A	25A	32A	40A	50A	63A
Cooling capacity	Total capacity	Nom.	kW	2.20	2.80	3.60	4.50	5.60	7.10
Heating capacity	Total capacity	Nom.	kW	2.50	3.20	4.00	5.00	6.30	8.00
Power input - 50Hz	Cooling	Nom.	kW	0.071			0.078	0.099	0.110
	Heating	Nom.	kW	0.068			0.075	0.096	0.107
Dimensions	Unit	HeightxWidthxDepth	mm	620 / 720x790x200			620 / 720x990x200		620 / 720x1.190x200
Weight	Unit		kg	23.5			27.5		32.0
Casing	Material			Galvanised steel plate					
Fan	Air flow rate - 50Hz	Cooling	Low/High	6.4/8.0			8.5/10.5	10.0/12.5	13.0/16.5
		Heating	Low/High	6.4/8.0			8.5/10.5	10.0/12.5	13.0/16.5
	External static pressure - 50Hz	Nom./High	Pa	10/41.0		10/42.0	15/52.0	15/59.0	15/55.0
Air filter	Type			Resin net					
Sound power level	Cooling	High	dBA	51			52	53	54
		Low/Nom./High	dBA	27.0/28.5/30.0			28.0/30.0/32.0	29.0/31.0/33.0	32.0/33.0/35.0
Sound pressure level	Heating	Low/Nom./High	dBA	27.0/28.5/30.0			28.0/30.0/32.0	29.0/31.0/33.0	32.0/33.0/35.0
		Type/GWP		R-410A/2,087.5					
Piping connections	Liquid	OD	mm	6.35					9.52
	Gas	OD	mm	12.7					15.9
	Drain			VP20 (I.D. 20/O.D. 26)					
Power supply	Phase/Frequency/Voltage		Hz/V	1~/50/60/220-240/220					
Current - 50Hz	Maximum fuse amps (MFA)		A	16					
Control systems	Infrared remote control			BRC4C65					
	Wired remote control			BRC1D52 / BRC1E53A/B/C / BRC1H519W/S/K					

# Floor standing unit

## For perimeter zone air conditioning

- › Unit can be installed as free standing model by use of optional back plate
- › Its low height enables the unit to fit perfectly beneath a window
- › Stylish modern casing finished in pure white (RAL9010) and iron grey (RAL7011) blends easily with any interior
- › Requires very little installation space

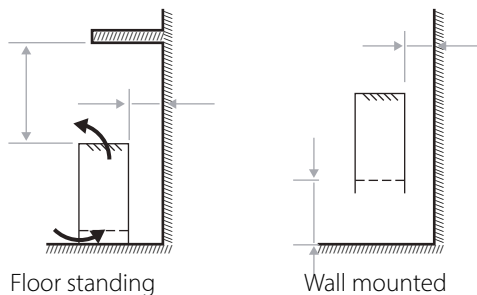

- › Wall mounted installation facilitates cleaning beneath the unit where dust tends to accumulate



- › Wired remote control can easily be integrated in the unit

 Access all technical information on FXLQ-P at [my.daikin.eu](http://my.daikin.eu) or click here

Indoor unit			FXLQ	20P	25P	32P	40P	50P	63P
Cooling capacity	Total capacity	Nom.	kW	2.2	2.8	3.6	4.5	5.6	7.1
Heating capacity	Total capacity	Nom.	kW	2.5	3.2	4.0	5.0	6.3	8.0
Power input - 50Hz	Cooling	Nom.	kW	0.05		0.09		0.11	
	Heating	Nom.	kW	0.05		0.09		0.11	
Dimensions	Unit	HeightxWidthxDensity	mm	600x1,000x232		600x1,140x232		600x1,420x232	
Weight	Unit		kg	27		32		38	
Fan	Air flow rate - 50Hz	Cooling	Low/High	m <sup>3</sup> /min		6.0/8		8.5/11	
		Low/High				11.0/14		12.0/16	
Air filter	Type			Resin net					
Sound power level	Cooling	High	dBA	54			57	58	59
	Heating	Low/High	dBA	32/35			33/38	34/39	35/40
Sound pressure level	Cooling	Low/High	dBA	32/35			33/38	34/39	35/40
	Heating	Low/High	dBA	32/35			33/38	34/39	35/40
Refrigerant	Type/GWP			R-410A/2,087.5					
Piping connections	Liquid	OD	mm	6.35				9.52	
	Gas	OD	mm	12.7				15.9	
	Drain			O.D. 21 (Vinyl chloride)					
Power supply	Phase/Frequency/Voltage		Hz/V	1~/50/60/220-240/220					
Current - 50Hz	Maximum fuse amps (MFA)		A	15					
Control systems	Infrared remote control			BRC4C65					
	Wired remote control			BRC1H519W/S/K / BRC1E53A/B/C / BRC1D52					

# VRV heatpump combined with stylish indoor units

Combine VRV indoor units with stylish indoor units

on a VRV IV heat pump

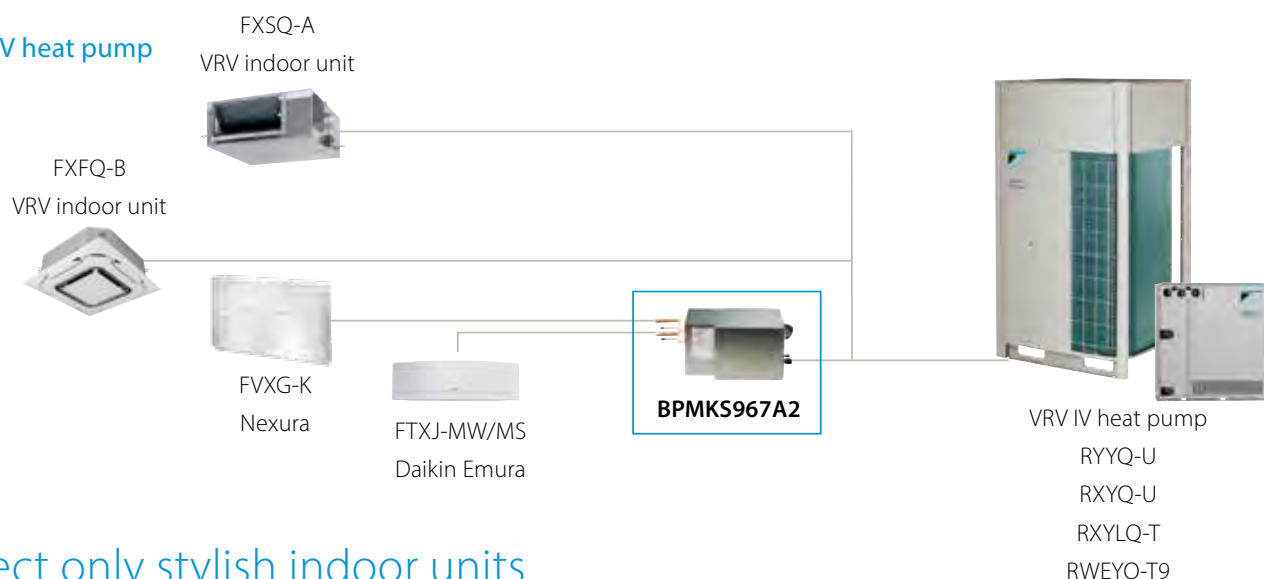

Connect only stylish indoor units to VRV IV S-series or VRV IV W-series outdoor units

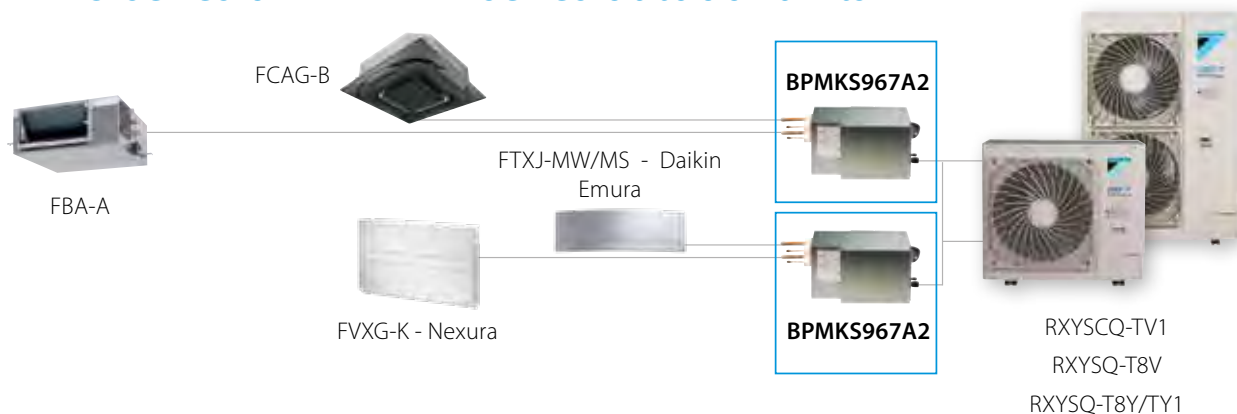

> \* Special order unit, contact your local sales representative for more information

**BPMKS967A**

## Branch provider

To connect Split and Sky Air indoor units to VRV outdoor units



Branch provider			BPMKS967A2	BPMKS967A2
Connectable indoor units			1~2	1~3
Max. indoor unit connectable capacity			14.2	20.8
Max. connectable combination			71+71	60+71+71
Dimensions	Height x Width x Depth	mm	180x294x350	
Weight		kg	7	8

# Daikin Emura Form. Function. Redesigned

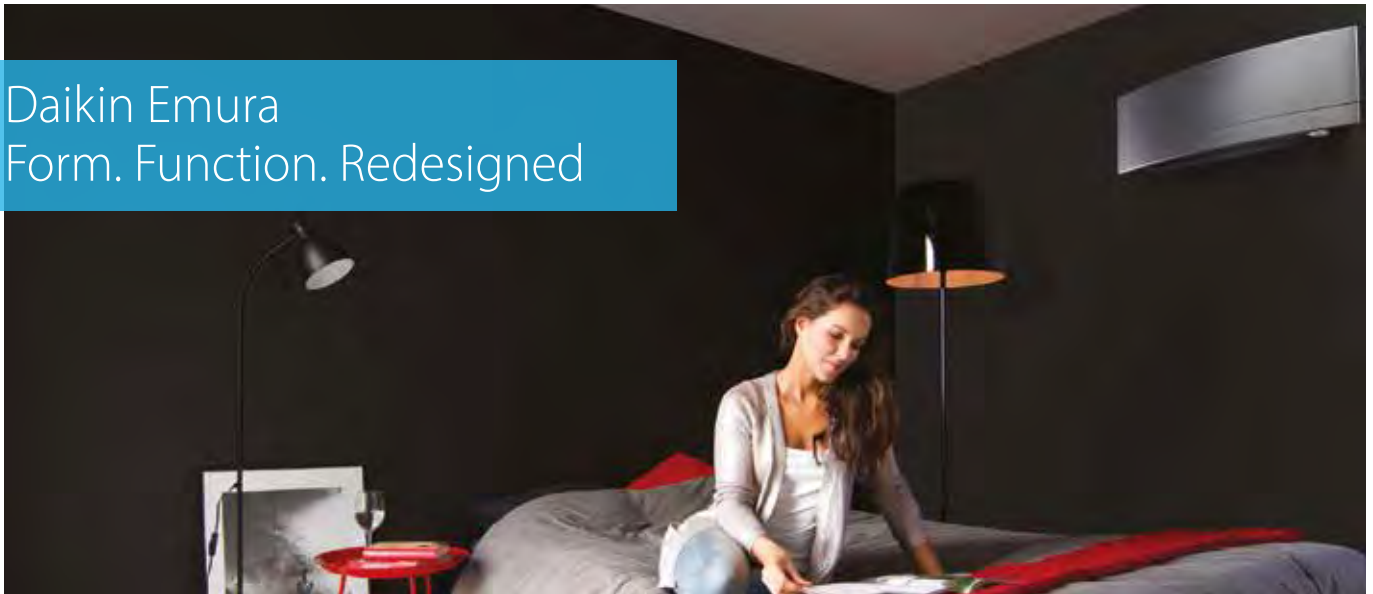

## Why choose Daikin Emura?

- Unique **design**. Designed in Europe for Europe.
- High seasonal **efficiency**, further improved by energy saving techniques like weekly timer and intelligent eye.
- Optimal **comfort** thanks to advanced technologies e.g. 2-area intelligent eye, whisper quiet operation and online controller.



## Benefits

- › A remarkable blend between iconic design and engineering excellence
- › Stylish design in matt crystal white and silver
- › Whisper quiet with sound levels down to 19 dBA
- › Horizontal and vertical autoswing
- › 2-area intelligent eye saves energy by reducing the set point if nobody is present and directs airflow away from people, thus avoiding cold draught
- › Weekly timer
- › Online controller: Always in control no matter where you are



## Wall mounted unit

Design at its best, delivering superior efficiency and comfort

- › Remarkable blend of iconic design and engineering excellence with an elegant finish in silver and anthracite or in matt crystal white
- › Daikin Emura has been awarded with Reddot design award 2014 by an international jury, thanks to its excellent design
- › Designed to perfectly balance technological leadership and the beauty of aerodynamics
- › Online controller (optional): control your indoor from any location with an app, via your local network or internet
- › Whisper quiet in operation: the operating of the unit can hardly be heard. The sound pressure level goes down to 19dBA!



Indoor unit		FTXJ		20MW	20MS	25MW	25MS	35MW	35MS	50MW	50MS
Dimensions	Unit	HeightxWidthxDepth		mm							
				303x998x212							
Weight	Unit			kg							
				12.0							
Air filter	Type			Removable / washable							
Fan	Air flow rate	Cooling	Silent operation/Low/Medium/High	2.6/4.4/6.6 /8.9				2.9/4.8/7.8 /10.9		3.6/6.8/8.9 /10.9	
		Heating	Silent operation/Low/Medium/High	3.8/6.3/8.4 /10.2		3.8/6.3/8.6 /11.0		4.1/6.9/9.6 /12.4		5.0/8.1/10.5 /12.6	
Sound power level	Cooling			54				59		60	
	Heating			56				59		60	
Sound pressure level	Cooling	Silent operation/Low/High		19/25/38				20/26/45		32/35/46	
	Heating	Silent operation/Low/High		19/28/40		19/28/41		20/29/45		32/35/47	
Control systems	Infrared remote control		ARC466A9								
	Wired remote control		-								
Power supply	Phase/Frequency/Voltage		Hz/V								
			1~/50/220-240								

# Wall mounted unit

Attractive, wall mounted design with perfect indoor air quality

- › Practically inaudible: the unit runs so quietly, you will almost forget it is there.
- › Cleaner air thanks to Daikin's Flash Streamer technology: you can breathe deep with no worries about impure air
- › 2 area motion detection sensor: air flow is sent to a zone other than where the person is located at that moment; if no people are detected, the unit will automatically switch over to the energyefficient setting.
- › Online controller: control your indoor from any location with an app, via your local network or internet and keep an overview on your energy consumption
- › Sleek, unobtrusive air conditioning unit that matches European sensibilities regarding interior design
- › 3-D air flow combines vertical and horizontal auto swing to circulate a stream of warm or cool air right to the corners of even large spaces



Indoor Units

Indoor unit		FTXM		CTXM15N	20N	25N	35N	42N	50N	60N	71N
Dimensions	Unit	HeightxWidthxDepth		mm							
Weight	Unit			kg							
Air filter	Type		-								
Fan	Air flow rate	Cooling	Silent operation/Low/High	m <sup>3</sup> /min							
		Heating	Silent operation/Low/High	m <sup>3</sup> /min							
Sound power level	Cooling			57		60		59	60	60	
	Heating			54		60		58	59	61	
Sound pressure level	Cooling	Silent operation/Low/Nom./High		19/41		19/45		21/45	44/27	30/46	32/47
	Heating	Silent operation/Low/Nom./High		20/39		21/45		31/43	33/45	34/46	
Control systems	Infrared remote control		ARC466A33								
	Wired remote control		BRC944B2 / BRC073A1				BRC944B2 / BRC073				
Power supply	Phase/Frequency/Voltage		Hz/V		1~/50/220-240						

\*Note: blue cells contain preliminary data

The best of two worlds united

# Pure comfort and design



## Why choose Nexura?

- Unique radiant heat panel that heats up just like a traditional radiator
- Whisper quiet operation down to 19 dBA
- Unobtrusive yet stylish design
- Reduced air flow, creating an even distribution of air through the room

### Comfort is key

Nexura makes your world a comfortable one. The coolness of a summer breeze or the cosiness of an extra heat source brings a feeling of well-being to your living space all year round. Its unobtrusive yet stylish design with a front panel that radiates additional heat, its low noise level and reduced air flow turn your room into a haven.

### Radiant heat panel

To add even more comfort on cold days, the aluminium front panel of the Nexura unit has the capability of warming up, just like a traditional radiator. The result? A comfortable feeling of warm air that envelopes you. And all you have to do to activate this unique feature is push the "radiant" button on your remote control.

### Benefits

- > Vertical autoswing
- > Weekly timer
- > Guaranteed operation down to -25°C (with RXLG-M)

### Online controller

Always in control, no matter where you are. Control your indoor from any location with an app, via your local network or internet.





## Floor standing unit with radiant heat panel

Stylish floor standing unit with radiant heat panel for comfortable heat and very low noise

- › The aluminium part of the front panel of the Nexura indoor unit has the capability of warming up, just like a traditional radiator, to add even more comfort on cold days
- › Quiet and discrete, Nexura offers you the best in heating and cooling, in comfort and design
- › The indoor unit distributes air at the sound of a whisper. The noise produced amounts to barely 22dB(A) in cooling and 19dB(A) in radiant heat mode. In comparison, the ambient sound in a quiet room amounts to 40dB(A) on average.
- › Comfortable vertical auto swing ensures draught-free operation and prevents ceiling soiling
- › Online controller (optional): control your indoor from any location with an app, via your local network or internet
- › Can be installed against a wall or recessed
- › Its low height enables the unit to fit perfectly beneath a window



Indoor unit		FVXG		25K	35K	50K
Dimensions	Unit	HeightxWidthxDepth	mm	600x950x215		
Weight	Unit		kg	22		
Air filter	Type			Removable / washable / mildew proof		
Fan - Air flow rate	Cooling	High/Low/Silent operation	m <sup>3</sup> /min	8.9/5.3/4.5	9.1/5.3/4.5	10.6/7.3/6.0
	Heating	High/Low/Silent operation	m <sup>3</sup> /min	9.9/5.7/4.7	10.2/5.8/5.0	12.2/7.8/6.8
Sound power level	Cooling		dB(A)	52		58
	Heating		dB(A)	53		60
Sound pressure level	Cooling	High/Low/Silent operation	dB(A)	38/26/23	39/27/24	44/36/32
	Heating	High/Low/Silent operation/Radiant heat	dB(A)	39/26/22/19	40/27/23/19	46/34/30/26
Control systems	Infrared remote control			ARC466A2		
Power supply	Phase / Frequency / Voltage		Hz / V	1~ / 50 / 220-240		

(3) Operation range in combination with Nexura, FVXG-K, cooling: min. 10°CDB - max. 46°CDB; heating: min. -15°CWB - max. 18°CWB

## Floor standing unit

Floor standing unit for optimal heating comfort thanks to dual airflow

- › Its low height enables the unit to fit perfectly beneath a window
- › Can be installed against a wall or recessed
- › Vertical auto swing moves the discharge flaps up and down for efficient air and temperature distribution throughout the room
- › Online controller (optional): control your indoor from any location with an app, via your local network or internet



Indoor unit				FVXM	25F	35F	50F
Dimensions	Unit	HeightxWidthxDepth		mm	600x700x210		
Weight	Unit			kg	14		
Air filter	Type				Removable / washable		
Fan	Air flow rate	Cooling	Silent operation/Low/Medium/High	m <sup>3</sup> /min	4.1/4.8/6.5 /8.2	4.5/4.9/6.7 /8.5	6.6/7.8/8.9 /10.1
		Heating	Silent operation/Low/Medium/High	m <sup>3</sup> /min	4.4/5.0/6.9 /8.8	4.7/5.2/7.3 /9.4	7.1/8.5/10.1 /11.8
Sound power level	Cooling			dBA	52		57
	Heating			dBA	52		58
Sound pressure level	Cooling	Silent operation/Low/High		dBA	23/26/38	24/27/39	32/36/44
	Heating	Silent operation/Low/High		dBA	23/26/38	24/27/39	32/36/45
Control systems	Infrared remote control				ARC452A1		
	Wired remote control				-		
Power supply	Phase/Frequency/Voltage		Hz/V	1~/50/220-230-240			

## Flexi type unit

Flexible unit, ideal for rooms without false ceiling, can fit on either ceiling or wall

- › Can fit on either ceiling or lower wall; its low height enables the unit to fit beneath a window
- › Vertical auto swing moves the discharge flaps up and down for efficient air and temperature distribution throughout the room
- › Home leave operation maintains the indoor temperature at your specified comfort level during absence, thus saving energy
- › Online controller (optional): control your indoor from any location with an app, via your local network or internet



Indoor unit		FLXS	25B	35B9	50B	60B	
Dimensions	Unit	HeightxWidthxDepth	490x1,050x200				
Weight	Unit	kg	16		17		
Air filter	Type		Removable / washable / mildew proof				
Fan - Air flow rate	Cooling	High/Low/Silent operation	m <sup>3</sup> /min	7.6/6.0/5.2	8.6/6.6/5.6	11.4/8.5/7.5	12.0/9.3/8.3
	Heating	High/Low/Silent operation	m <sup>3</sup> /min	9.2/7.4/6.6	12.8/8.0/7.2	12.1/7.5/6.8	12.8/8.4/7.5
Sound power level	Cooling		dBA	51	53	60	
	Heating		dBA	51	59	-	59
Sound pressure level	Cooling	High/Low/Silent operation	dBA	37/31/28	38/32/29	47/39/36	48/41/39
	Heating	High/Low/Silent operation	dBA	37/31/29	46/33/30	46/35/33	47/37/34
Control systems	Infrared remote control		ARC433B67				
Power supply	Phase / Frequency / Voltage		Hz / V	1~ / 50/60 / 220-240/220-230	1~ / 50 / 220-240	1~ / 50/60 / 220-240/220-230	1~ / 50 / 230



## Hot water



Efficient hot water production for underfloor heating, radiators and air handling units, or for producing hot water for sinks, baths and showers. Integrating heat recovery into the VRV system means that the production of hot water is virtually free.

# Hot water

Low temperature hydrobox	
HXY-A8	134
High temperature hydrobox	
HXHD-A8	135
Accessories for hot water	136

## Hydrobox range

Capacity class (kW)

Type	Product name	Model	80	125	200	Leaving water temperature range
Low temperature hydrobox	HXY-A8 	<p><b>For high efficiency space heating and cooling</b></p> <ul style="list-style-type: none"> <li>&gt; Ideal for hot or cold water in underfloor, air handling units, low temperature radiators ...</li> <li>&gt; Hot/cold water from 5° to 45°C</li> <li>&gt; Large operation range (down to -20°C and up to 43°C)</li> <li>&gt; Fully integrated water-side components save time on system design</li> <li>&gt; Space saving contemporary wall hung design</li> </ul>	●	●		5 °C - 45 °C
High temperature hydrobox	HXHD-A8 	<p><b>For efficient hot water production and space heating</b></p> <ul style="list-style-type: none"> <li>&gt; Ideal for hot water in bathrooms, sinks and for underfloor heating, radiators, air handling units, ...</li> <li>&gt; Hot water from 25 to 80°C</li> <li>&gt; "Free" heating and hot water through heat recovery</li> <li>&gt; Uses heat pump technology to produce hot water efficiently, providing up to 17% savings compared to a gas boiler</li> <li>&gt; Possibility to connect thermal solar collectors</li> </ul>		●	●	25 °C - 80 °C

# Low temperature hydrobox for VRV

For high efficiency space heating and cooling

- › Air to water connection to VRV for applications such as underfloor, air handling units, low temperature radiators, ...
- › Leaving water temperature range from 5°C to 45°C without electric heater
- › Super wide operating range for hot/cold water production from -20 to +43°C ambient outdoor temperature
- › Saves time on system design as all water-side components are fully integrated with direct control over leaving water temperature
- › Space saving contemporary wall hung design
- › No gas connection or oil tank needed
- › Connectable to VRV IV heat pump and heat recovery

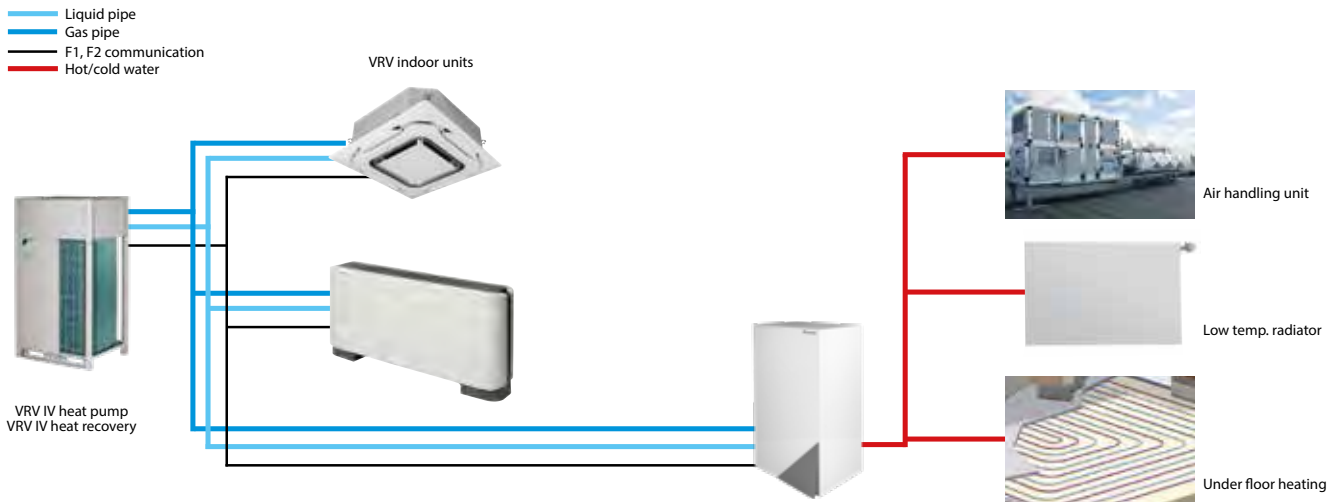

Access all technical information on HXY-A8 at [my.daikin.eu](http://my.daikin.eu) or click here

Indoor Unit		HXY	080A8	125A8	
Cooling capacity	Nom.	kW	8.0 (1)	12.5 (1)	
Heating capacity	Nom.	kW	9.00 (2)	14.00 (2)	
Dimensions	Unit	HeightxWidthxDepth	890x480x344		
Weight	Unit	kg	44		
Casing	Colour		White		
	Material		Precoated sheet metal		
Sound pressure level	Nom.	dB(A)	-		
Operation range	Heating	Ambient	Min.~Max.	°C	
		Water side	Min.~Max.	°C	
	Domestic hot water	Ambient	Min.~Max.	°C	DB
		Water side	Min.~Max.	°C	
Refrigerant	Type		R-410A		
	GWP		2,087.5		
Refrigerant circuit	Gas side diameter	mm	15.9		
	Liquid side diameter	mm	9.5		
Water circuit	Piping connections diameter	inch	G 1"1/4 (female)		
Power supply	Phase/Frequency/Voltage	Hz/V	1~/50/220-240		
Current	Recommended fuses	A	6~16		

(1) Tamb 35°C - LWE 18°C (DT=5°C) (2) DB/WB 7°C/6°C - LWC 35°C (DT=5°C) (3) Flow switch setting

# High temperature hydrobox for VRV

For efficient hot water production and space heating

- › Air to water connection to VRV for applications such as bathrooms, sinks, underfloor heating, radiators and air handling units
- › Leaving water temperature range from 25 to 80°C without electric heater
- › „Free“ heating and hot water production provided by transferring heat from areas requiring cooling to areas requiring heating or hot water
- › Uses heat pump technology to produce hot water efficiently, providing up to 17% savings compared to a gas boiler
- › Possibility to connect thermal solar collectors to the domestic hot water tank
- › Super wide operating range for hot water production from -20 to +43°C ambient outdoor temperature
- › Saves time on system design as all water-side components are fully integrated with direct control over leaving water temperature
- › Various control possibilities with weather dependant set point or thermostat control
- › The indoor unit and domestic hot water tank can be stacked to save space, or installed next to each other, if only limited height is available
- › No gas connection or oil tank needed
- › Connectable to VRV IV heat recovery

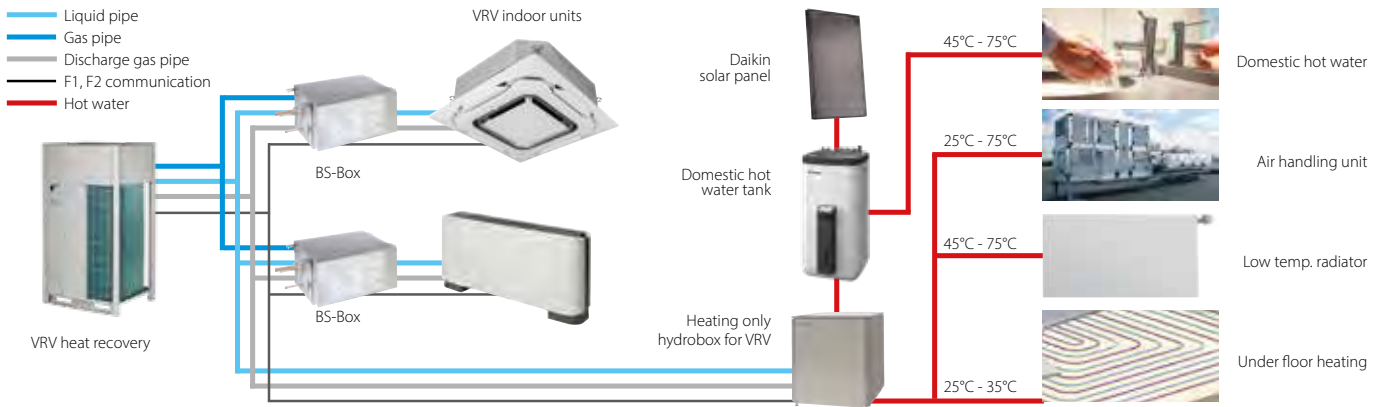

 Access all technical information on HXHD-A8 at [my.daikin.eu](http://my.daikin.eu) or click here

Indoor Unit		HXHD		125A	200A	
Heating capacity	Nom.			kW	14.0	22.4
Dimensions	Unit	Height x Width x Depth			705 x 600 x 695	
Weight	Unit			kg	92.0	147
Casing	Colour					Metallic grey
	Material					Precoated sheet metal
Sound power level	Nom.			dB(A)	55.0 (2)	60.0 (2)
Sound pressure level	Nom.			dB(A)	42.0 (2) / 43.0 (3)	46.0 (2) / 46.0
	Night quiet mode	Level 1		dB(A)	38 (2)	45 (2)
Operation range	Heating	Ambient	Min. ~ Max.	°C	-20.0 ~ 20 / 24 (1)	
		Water side	Min. ~ Max.	°C	25 ~ 80.0	
	Domestic hot water	Ambient	Min. ~ Max.	°CDB	-20.0 ~ 43.0	
		Water side	Min. ~ Max.	°C	45 ~ 75	
Refrigerant	Type					R-134a
	GWP					1,430
	Charge			kg	2.00	2.60
Water circuit	Piping connections diameter			inch	G 1" (female)	
	Heating water system	Water volume	Max. ~ Min.	l	200 ~ 20	400 ~ 20
Power supply	Phase / Frequency / Voltage			Hz / V	1 ~ / 50 / 220-240	3 ~ / 50 / 380-415
Current	Recommended fuses			A	20	16

(1) Field setting | (2) Sound levels are measured at: EW 55°C; LW 65°C | (3) Sound levels are measured at: EW 70°C; LW 80°C

# Domestic hot water tank

## Plastic domestic hot water tank with solar support

- › Tank designed for connection with drainback thermal solar system
- › Available in 300 and 500 liters
- › Large hot water storage tank to provide domestic hot water at any time
- › Heat loss is reduced to a minimum thanks to the high quality insulation
- › Space heating support possible (500l tank only)



Accessory		EKHWP	300B	500B
Casing	Colour		Traffic white (RAL9016) / Dark grey (RAL7011)	
	Material		Impact resistant polypropylene	
Dimensions	Unit	Width	mm	595
		Depth	mm	615
		Empty	kg	58
Weight Tank	Water volume		l	294
	Material			Polypropylen
Heat exchanger	Maximum water temperature		°C	85
	Insulation	Heat loss	kWh/24h	1.5
		Energy efficiency class		B
		Standing heat loss	W	64
		Storage volume	l	294
		Quantity		1
Domestic hot water	Tube material			Stainless steel (DIN 1.4404)
	Face area	m <sup>2</sup>	5,600	5,800
	Internal coil volume	l	27.1	28.1
	Operating pressure	bar		6
	Average specific thermal output	W/K	2,790	2,825
	Charging	Quantity		1
Charging	Tube material			Stainless steel (DIN 1.4404)
	Face area	m <sup>2</sup>	3	4
	Internal coil volume	l	13	18
	Operating pressure	bar		3
	Average specific thermal output	W/K	1,300	1,800
	Auxiliary solar heating	Tube material		
	Face area	m <sup>2</sup>	-	1
	Internal coil volume	l	-	4
	Operating pressure	bar	-	3
	Average specific thermal output	W/K	-	280

## EKHWP-PB

# Domestic hot water tank

## Pressureless domestic hot water tank with solar support

- › Tank designed for connection with pressurised thermal solar system
- › Available in 300 and 500 liters
- › Large hot water storage tank to provide domestic hot water at any time
- › Heat loss is reduced to a minimum thanks to the high quality insulation
- › Space heating support possible (500l tank only)



Accessory		EKHWP	300PB	500PB	
Casing	Colour		Traffic white (RAL9016) / Dark grey (RAL7011)		
	Material		Impact resistant polypropylene		
Dimensions	Unit	Width	mm	595	
		Depth	mm	615	
		Empty	kg	58	
Weight Tank	Water volume		l	294	
	Material			Polypropylen	
Heat exchanger	Maximum water temperature		°C	85	
	Insulation	Heat loss	kWh/24h	1.5	
		Energy efficiency class		B	
		Standing heat loss	W	64	
		Storage volume	l	294	
		Quantity		1	
Domestic hot water	Tube material			Stainless steel (DIN 1.4404)	
	Face area	m <sup>2</sup>	5,600	5,900	
	Internal coil volume	l	27.1	28.1	
	Operating pressure	bar		6	
	Average specific thermal output	W/K	2,790	2,825	
	Charging	Quantity		1	
Charging	Tube material			Stainless steel (DIN 1.4404)	
	Face area	m <sup>2</sup>	3	4	
	Internal coil volume	l	13	18	
	Operating pressure	bar		3	
	Average specific thermal output	W/K	1,300	1,800	
	Pressurised solar	Average specific thermal output	W/K	390.00	840.00
Auxiliary solar heating	Tube material			Stainless steel (DIN 1.4404)	
	Face area	m <sup>2</sup>	-	1	
	Internal coil volume	l	-	4	
	Operating pressure	bar	-	3	
		Average specific thermal output	W/K	-	280



# Solar collector

## Thermal solar collector for hot water production

- › Solar collectors can produce up to 70% of the energy needed for hot water production – a major cost saving
- › Horizontal and vertical solar collector for domestic hot water production
- › High efficiency collectors transfer all the short-wave solar radiation into heat as a result of their highly selective coating
- › Easy to install on roof tiles

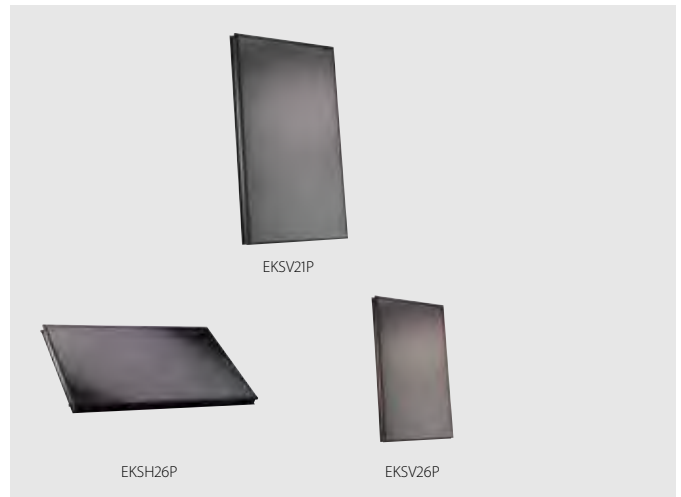

Accessory		EKSV/EKSH	21P	26P
Mounting			Vertical	
Dimensions	Unit	HeightxWidthxDepth	1,006x85x2,000	
Weight	Unit		33	42
Volume		l	1.3	1.7
Surface	Outer	m <sup>2</sup>	2.01	2.60
	Aperture	m <sup>2</sup>	1.800	2.360
	Absorber	m <sup>2</sup>	1.79	2.35
Coating			Micro-therm (absorption max. 96%, Emission ca. 5% +/-2%)	
Absorber			Harp-shaped copper pipe register with laser-welded highly selective coated aluminium plate	
Glazing			Single pane safety glass, transmission +/- 92%	
Allowed roof angle	Min.~Max.	°	15~80	
Operating pressure	Max.	bar	6	
Stand still temperature	Max.	°C	192	
Thermal performance	collector efficiency (η <sub>col</sub> )	%	61	
	Zero loss collector efficiency η <sub>0</sub>	%	0.781	0.784
	Heat loss coefficient a <sub>1</sub>	W/m <sup>2</sup> .K	4.240	4.250
	Temperature dependence of the heat loss coefficient a <sub>2</sub>	W/m <sup>2</sup> .K <sup>2</sup>	0.006	0.007
	Thermal capacity	kJ/K	4.9	6.5
Auxiliary	Solpump	W	-	
	Solstandby	W	-	
	Annual auxiliary electricity consumption Q <sub>aux</sub>	kWh	-	

## EKSRDS2A/EKSRPS4A

# Pump station

- › Save energy and reduce CO<sub>2</sub> emissions with a solar system for domestic hot water production
- › Pump station connectable to unpressurised solar system
- › Pump station and control provide the transfer of solar heat to the domestic hot water tank



Accessory		EKSRPS4A/EKSRDS2A	EKSRPS4A	EKSRDS2A
Mounting			On side of tank	On wall
Dimensions	Unit	HeightxWidthxDepth	815x142x230	410x314x154
Weight	Unit		6	
Operation range	Ambient temperature	Min.~Max.	5~40	0~40
Operating pressure	Max.	bar	-	6
Stand still temperature	Max.	°C	85	120
Thermal performance	collector efficiency (η <sub>col</sub> )	%	-	
	Zero loss collector efficiency η <sub>0</sub>	%	-	
Control	Type		Digital temperature difference controller with plain text display	
	Power consumption	W	2	5
Power supply	Phase/Frequency/Voltage	Hz/V	1~/50/230	/50/230
Sensor	Solar panel temperature sensor		Pt1000	
	Storage tank sensor		PTC	-
	Return flow sensor		PTC	-
	Feed temperature and flow sensor		Voltage signal (3.5V DC)	-
Power supply intake			Indoor unit	
Auxiliary	Solpump	W	30	23
	Solstandby	W	2.00	5.00
	Annual auxiliary electricity consumption Q <sub>aux</sub>	kWh	78	89

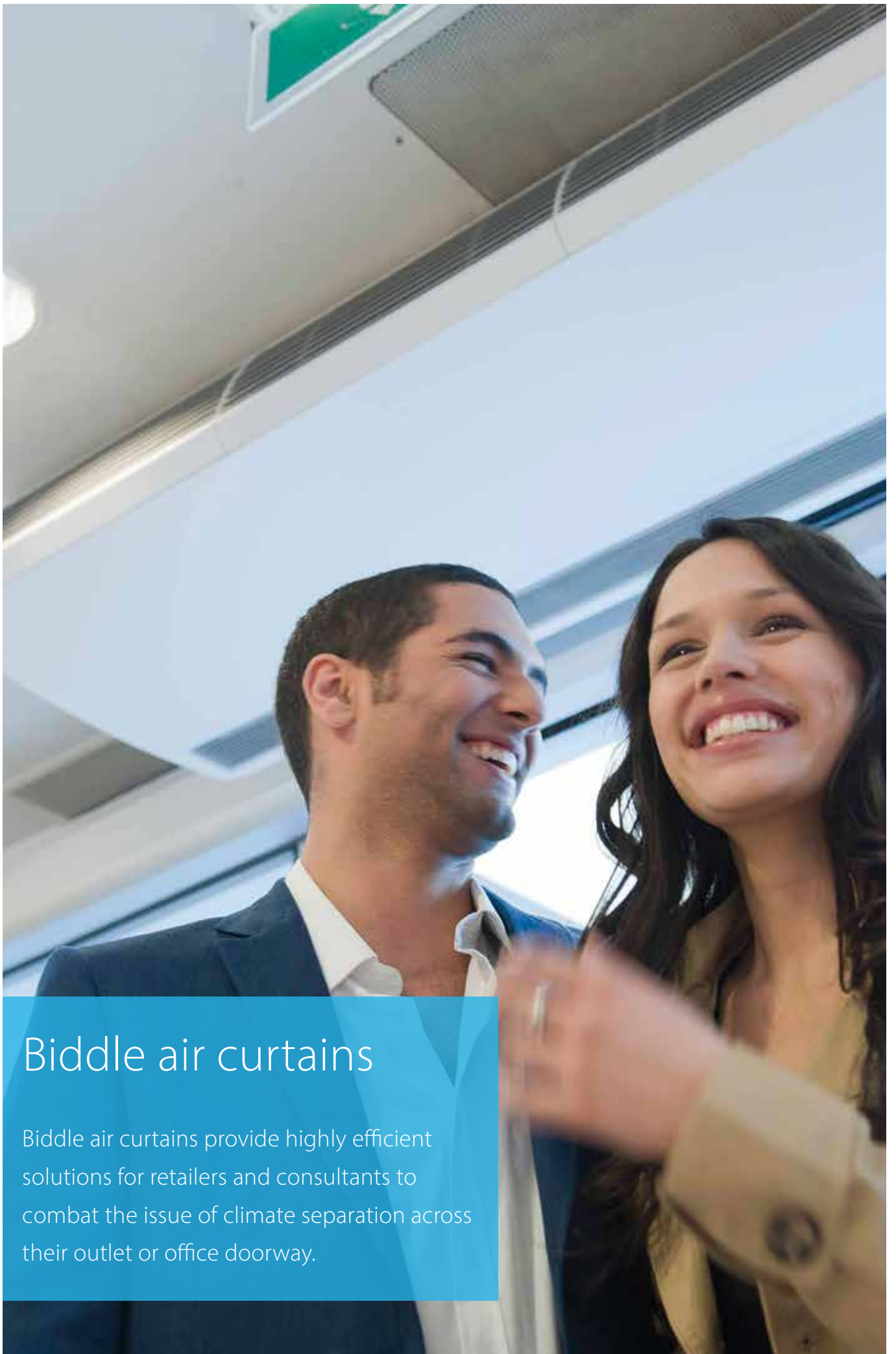

## Biddle air curtains

Biddle air curtains provide highly efficient solutions for retailers and consultants to combat the issue of climate separation across their outlet or office doorway.

# Biddle air curtains

## connected to Daikin Heat Pumps

### 'Open Door' Trading

Although the customer-friendly aspects of open door trading are widely appreciated by retail and commercial outlet managers, open doors can also give rise to massive losses in conditioned warm or cold air and hence, energy. Biddle air curtains however, not only preserve indoor temperatures and generate significant savings, they also represent an invitation for customers, to enter a pleasant trading and working environment.

### High efficiency and low CO<sub>2</sub> emission

An efficient outdoor/indoor climate separation limits heat loss through the door opening and enhances the efficiency of the air conditioning system. Combining Biddle air curtains with Daikin heat pumps can lead to savings up to 72% compared to electric air curtains and a payback period of less than 1.5 years!

### Air curtain size selector

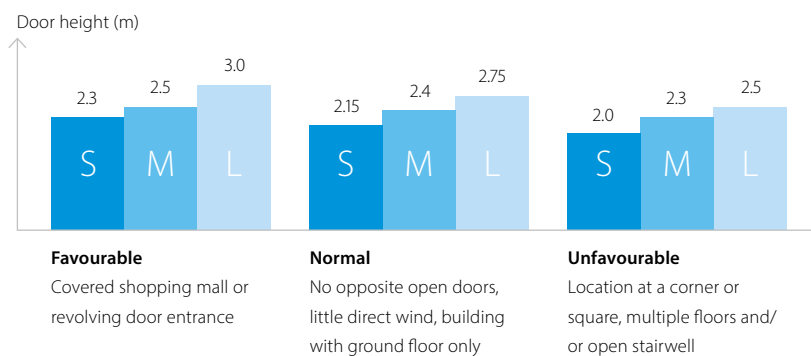

### Biddle comfort air curtain nomenclature

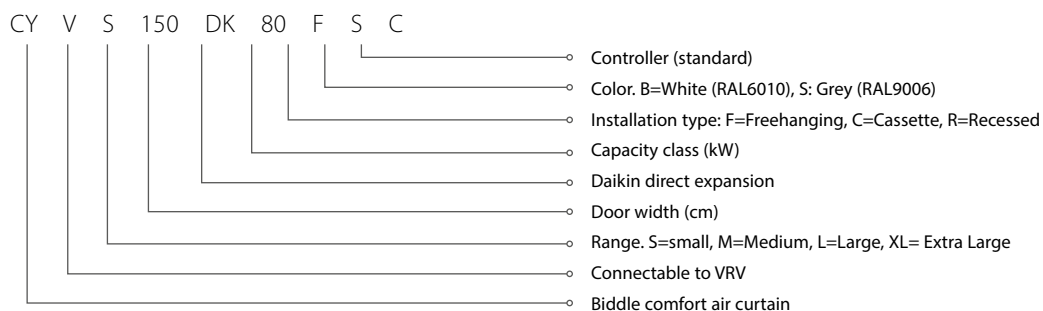

## Portfolio

Type	Product name	
Biddle air curtain free hanging	CYV S/M/L-DK-F	
Biddle air curtain cassette	CYV S/M/L-DK-C	
Biddle air curtain recessed	CYV S/M/L-DK-R	

- › A payback time of less than 1.5 years compared to electrical air curtains
- › Easy and quick installation
- › Maximum energy efficiency thanks to rectifier technology
- › 85% air separation efficiency
- › Cassette model (C): mounted into a false ceiling enhancing aesthetics
- › Free-hanging model (F): easy wall mounted installation
- › Recessed model (R) : neatly concealed in the ceiling

# Biddle air curtain for VRV

- › Connectable to VRV heat recovery and heat pump
- › VRV is among the first DX systems suitable for connection to air curtains
- › Free-hanging model (F): easy wall mounted installation
- › Cassette model (C): mounted into a false ceiling leaving only the decoration panel visible
- › Recessed model (R): neatly concealed in the ceiling
- › Provides virtually free air curtain heating via recovered heat from indoor units in cooling mode (in case of VRV heat recovery)
- › Easy and quick to install at reduced costs since no additional water systems, boilers and gas connections are required
- › **PATENTED TECHNOLOGY:** Maximum energy efficiency stemming from almost zero down flow turbulence, optimised air flow and the application of advanced discharge rectifier technology
- › Around 85% air separation efficiency, greatly reducing both heat loss and required indoor unit heating capacity

## Packtime of less than 1.5 years

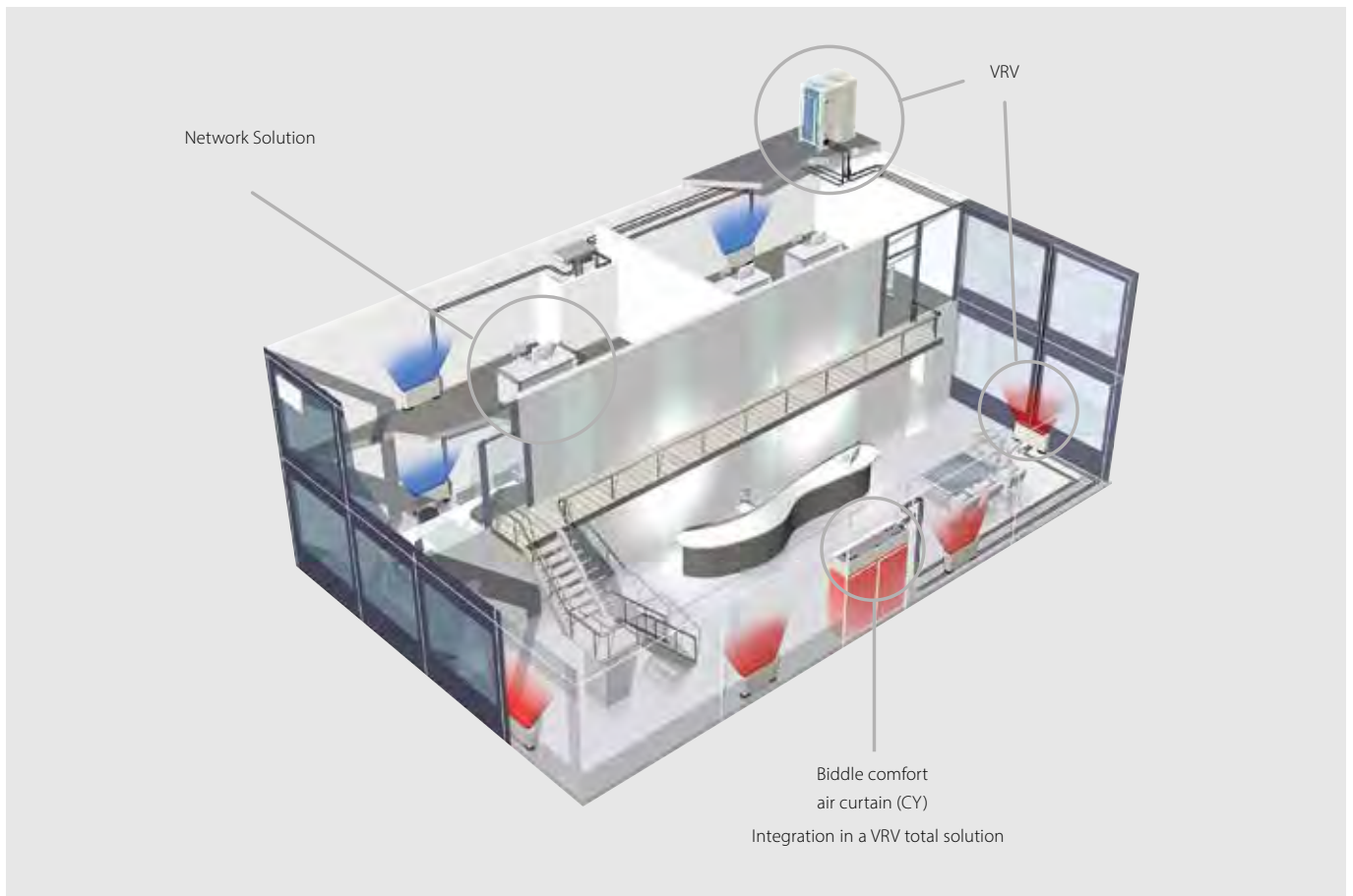
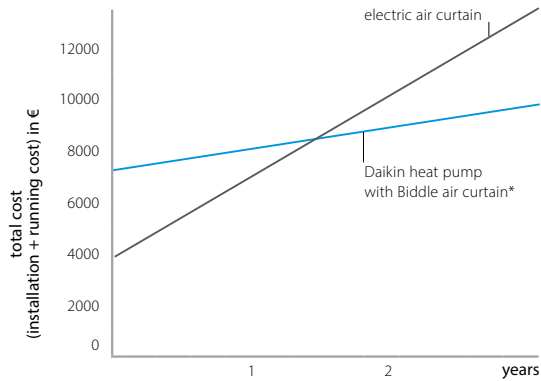

\* Payback period and gains calculated based upon the following: Air curtain is 9hrs/day – 156 days year (1,404 hrs/year) in use. Annual energy consumption for an electric air curtain: 3,137EUR (COP = 0.95). Typical installation cost: 1,000EUR; Typical equipment cost: 2,793EUR. Annual energy consumption for CYQS200DK100FBN and ERQ100AV: 748EUR (COP 4.00). Typical installation cost: 2,000EUR; Typical equipment cost: 5,150EUR. Calculation based upon electricity cost: 0,1705EUR /kWh

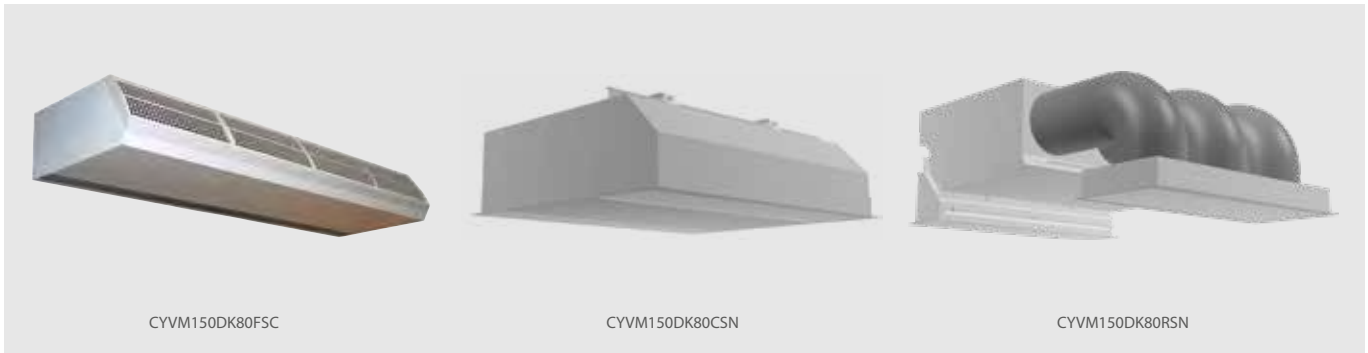

 Access all technical information on Biddle air curtains at [my.daikin.eu](http://my.daikin.eu) or click here

				Small				Medium			
				CYVS100DK80 *BC/*SC	CYVS150DK80 *BC/*SC	CYVS200DK100 *BC/*SC	CYVS250DK140 *BC/*SC	CYVM100DK80 *BC/*SC	CYVM150DK80 *BC/*SC	CYVM200DK100 *BC/*SC	CYVM250DK140 *BC/*SC
Heating capacity	Speed 3		kW	7.40	9.0	11.6	16.2	9.2	11.0	13.4	19.9
Power input	Fan only	Nom.	kW	0.23	0.35	0.46	0.58	0.37	0.56	0.75	0.94
	Heating	Nom.	kW	0.23	0.35	0.46	0.58	0.37	0.56	0.75	0.94
Delta T	Speed 3		K	19	15		16	17	14	13	15
Casing	Colour	BN: RAL9010 / SN: RAL9006									
Dimensions	Unit	Height F/C/R	mm	270/270/270							
		Width F/C/R	mm	1,000/1,000/1,048	1,500/1,500/1,548	2,000/2,000/2,048	2,500/2,500/2,548	1,000/1,000/1,048	1,500/1,500/1,548	2,000/2,000/2,048	2,500/2,500/2,548
		Depth F/C/R	mm	590/821/561							
Required ceiling void >			mm	420							
Door height	Max.		m	23 (1) / 215 (2) / 20 (3)	23 (1) / 215 (2) / 20 (3)	23 (1) / 215 (2) / 20 (3)	23 (1) / 215 (2) / 20 (3)	25 (1) / 24 (2) / 23 (3)	25 (1) / 24 (2) / 23 (3)	25 (1) / 24 (2) / 23 (3)	25 (1) / 24 (2) / 23 (3)
Door width	Max.		m	1.0	1.5	2.0	2.5	1.0	1.5	2.0	2.5
Weight	Unit		kg	56	66	83	107	57	73	94	108
Fan-Air flow rate	Heating	Speed 3	m <sup>3</sup> /h	1,164	1,746	2,328	2,910	1,605	2,408	3,210	4,013
Sound pressure level	Heating	Speed 3	dB(A)	47	49	50	51	50	51	53	54
Refrigerant	Type / GWP	R-410A / 2,087.5									
Piping connections	Liquid/OD/Gas/OD		mm	9.52/16.0			9.52/19.0	9.52/16.0			9.52/19.0
Required accessories (should be ordered separately)		Daikin wired remote control (BRC1H51(9)W/S/K / BRC1E53A/B/C / BRC1D52)									
Power supply	Voltage		V	230							

				Large				
				CYVL100DK125*BC/*SC	CYVL150DK200*BC/*SC	CYVL200DK250*BC/*SC	CYVL250DK250*BC/*SC	
Heating capacity	Speed 3		kW	15.6	23.3		29.4	31.1
Power input	Fan only	Nom.	kW	0.75	1.13		1.50	1.88
	Heating	Nom.	kW	0.75	1.13		1.50	1.88
Delta T	Speed 3		K	15			14	12
Casing	Colour	BN: RAL9010 / SN: RAL9006						
Dimensions	Unit	Height F/C/R	mm	370/370/370				
		Width F/C/R	mm	1,000/1,000/1,048	1,500/1,500/1,548		2,000/2,000/2,048	2,500/2,500/2,548
		Depth F/C/R	mm	774/1,105/745				
Required ceiling void >			mm	520				
Door height	Max.		m	3.0 (1) / 2.75 (2) / 2.5 (3)	3.0 (1) / 2.75 (2) / 2.5 (3)	3.0 (1) / 2.75 (2) / 2.5 (3)	3.0 (1) / 2.75 (2) / 2.5 (3)	
Door width	Max.		m	1.0	1.5	2.0	2.5	
Weight	Unit		kg	76	100	126	157	
Fan-Air flow rate	Heating	Speed 3	m <sup>3</sup> /h	3,100	4,650	6,200	7,750	
Sound pressure level	Heating	Speed 3	dB(A)	53	54	56	57	
Refrigerant	Type / GWP	R-410A / 2,087.5						
Piping connections	Liquid/OD/Gas/OD		mm	9.52/16.0	9.52/19.0		9.52/22.0	
Required accessories (should be ordered separately)		Daikin wired remote control (BRC1H51(9)W/S/K / BRC1E53A/B/C / BRC1D52)						
Power supply	Voltage		V	230				

(1) Favorable conditions: covered shopping mall or revolving door entrance (2) Normal conditions: little direct wind, no opposite open doors, building with ground floor only  
 (3) Unfavorable conditions: location at a corner or square, multiple floors and/or open stairway



Daikin offers the widest range in DX ventilation in the market.

With a variety of ventilation solutions from small heat recovery ventilation to large scale air handling units we help provide a fresh, healthy and comfortable environment in offices, hotels, stores and other commercial environments.

Abluft



# Ventilation & air handling

## Why choose Daikin ventilation 144

ERV / HRV - Heat reclaim ventilation units	148
<b>NEW</b> ALB-LBS/RBS - Modular L Smart	148
ALD electrical heater	149
VAM-FC / J	150
VH-B electrical heater	151
VKM-GB(M)	152
Daikin air handling units with DX connection	153
Advantages	153
Overview of VRV & ERQ DX units	154
Control possibilities	155
Integration in third party AHU	158
Expansion valves & Control boxes	158
Selection procedure	159



## 5 reasons why Daikin's ventilation range is unique in the market

### 1 Market leading controls & connectivity

- › Interlock of ventilation and air conditioning system
  - Control ERV/HRV and air conditioning from the same controller
  - Aligns the operation mode between the systems to save energy
- › Easy integration in the total solution
  - Online control and monitoring via the Daikin Cloud Service
  - Full portfolio integration in the intelligent Touch Manager, Daikins cost-effective mini BMS
- › User-friendly controller with premium design
  - Intuitive touch button control

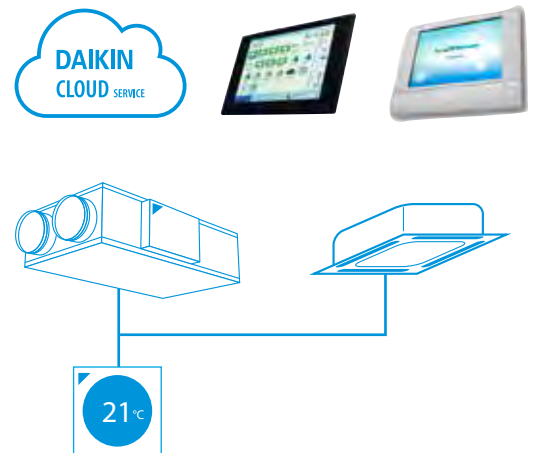

Madoka



red dot award 2018 winner

### 2 Unique installation benefits

- › Integrates seamlessly in the Daikin total solution, ensuring a single point of contact
- › Total fresh air solution with Daikin supplying both the VAM/Modular L Smart and the electrical heater
- › Daikin AHU and condensing unit connect Plug & Play thanks to same pipe diameters, factory mounted controls, expansion valves, etc.







### 3 High energy efficiency

- › Energy recovery of up to 92%, reducing running costs
- › Free nighttime cooling using fresh outside air
- › Inverter driven centrifugal fans
- › ErP compliant

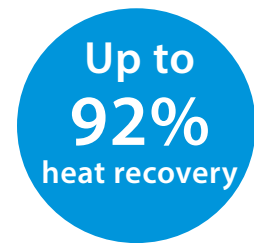

### 4 Best comfort

- › Wide range of units to control fresh air and humidity
- › Wide range of optional filters to suit the application available up to ePM<sub>1</sub> 80% (F9)
- › Special paper heat exchanger recovers heat and moisture from outgoing air to warm up and humidify incoming air to comfortable levels (VAM, VKM)



### 5 Top reliability

- › Most extensive testing before new units leave the factory
- › Widest support network and after sales service
- › All spare parts available in Europe



## Did you know?

CO<sub>2</sub> levels and ventilation rates all have significant, independent impacts on cognitive function:

#### COGNITIVE FUNCTION SCORES ...



**+ 61%**  
IN GREEN BUILDING  
CONDITIONS



**+ 101%**  
IN ENHANCED  
GREEN BUILDING CONDITIONS

# Widest range of DX integrated ventilation on the market

Daikin offers a variety of solutions from small heat recovery ventilation to large-scale air handling units for the provision of fresh air ventilation to homes, or commercial premises.

## Ventilation solutions

Daikin offers state-of-the-art ventilation solutions that can easily be integrated into any project:

- › **Unique portfolio** within DX manufacturers
- › High-quality solutions complying with the **highest Daikin quality standards**
- › **Seamless integration** of all products to provide the best indoor climate
- › All Daikin products connected to a single controller for **complete control** of the HVAC system.

## Heat Reclaim Ventilation - Ventilation with heat recovery as standard

Our heat recovery units **recover sensible heat** (Modular L / Modular L Smart) and **latent heat** (VAM/VKM), substantially reducing the load on the air conditioning system up to 40%.

## Ventilation with DX connection - Control over fresh air temperature

Daikin offers a range of inverter condensing units to be used in combination with Daikin AHUs for ultimate control over the fresh air. There are 4 control possibilities when **combining AHU and Daikin outdoor units** hence offering all the required flexibility for any installation. Indoor units can be combined to the same outdoor unit to reduce the installation costs. For **false-ceiling installations** where space is a constraint, the VKM can fit perfectly to deliver fresh air at a comfortable temperature and it has an optional humidification element.

### Five components of indoor air quality

- › **Ventilation:** Ensures the provision of fresh air
- › **Energy recovery:** Delivers energy savings by transferring heat and moisture between airflows
- › **Air processing:** Delivers the right supply temperature to decrease the indoor unit load
- › **Humidification:** Ensures relative indoor humidity levels are respected
- › **Filtration:** Separates pollen, dust and pollution odours that are harmful to individuals' health

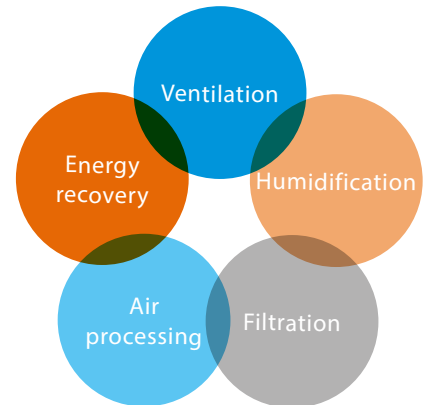

### Fresh air portfolio

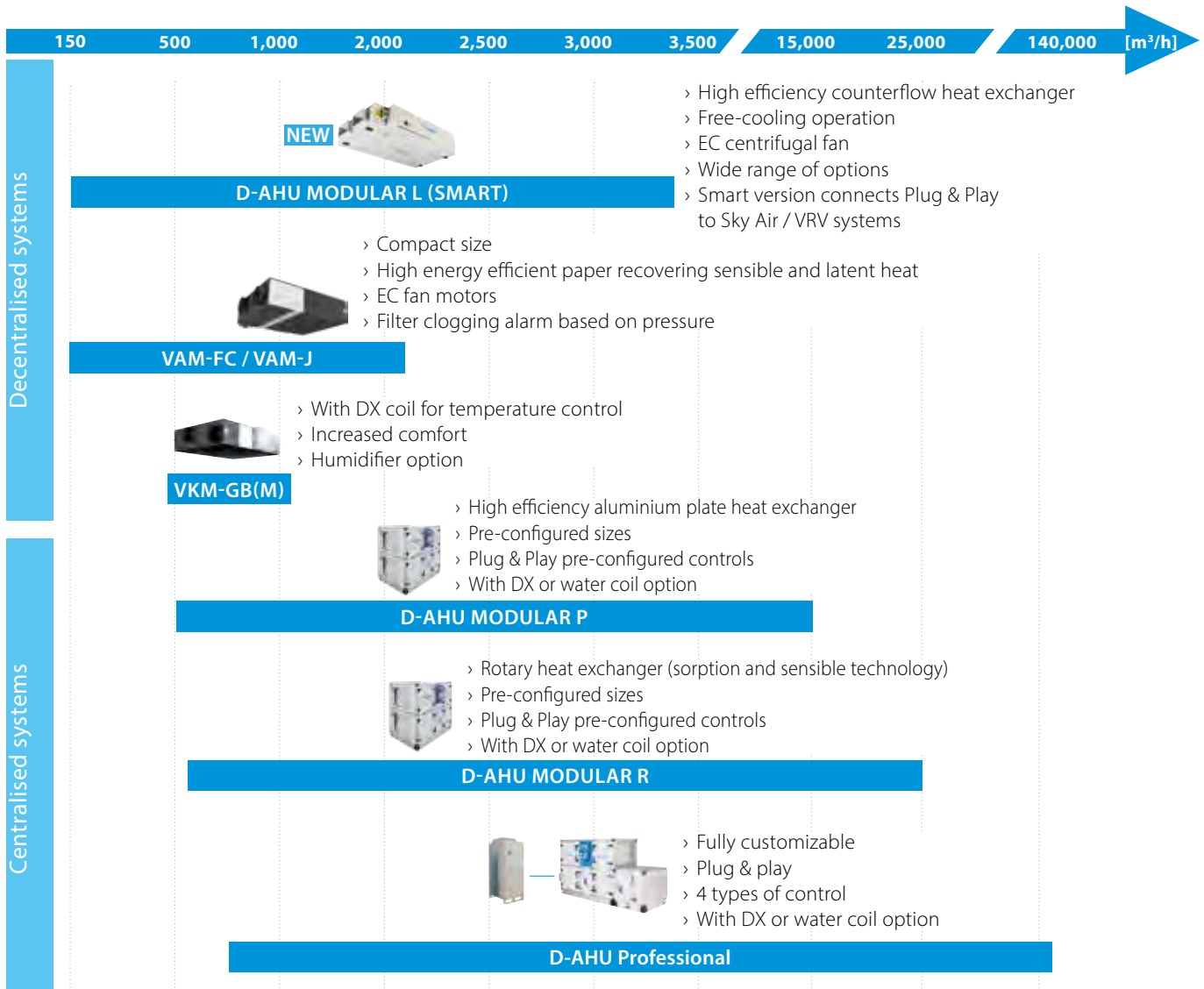

# Modular L Smart

Premium efficiency heat recovery unit

## Highlights

- › Connects Plug&Play into the Sky Air and VRV control network
- › Easy installation and commissioning
- › Internal pre-filter stage (up to ePM<sub>1</sub> 50% (F7) + ePM<sub>1</sub> 80% (F9)) making the unit reach highest indoor air quality requirements.
- › Wide air flow coverage from 150m<sup>3</sup>/h to 3,450m<sup>3</sup>/h
- › Exceeding ERP 2018 requirements
- › Best choice when compactness is needed (only 280 mm height up to 550 m<sup>3</sup>/h)
- › 50 mm double skin panel (120 kg/m<sup>3</sup>) for a maximum sound and thermal insulation

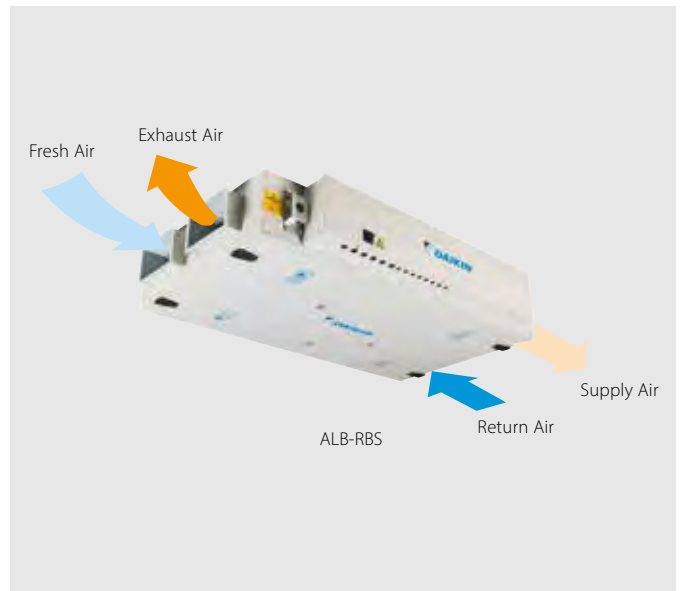

## EC centrifugal fan

- › Maximum ESP available 600 Pa (depending on model sizes and airflow)
- › Inverter driven with IE4 premium efficiency motor
- › High-efficient blade profiling
- › Reduced energy consumption
- › Optimized SFP (Specific Fan Power) for an efficient unit operation

## Heat exchanger

- › Premium quality counter flow plate heat exchanger
- › Up to 93% of the thermal energy recovered
- › High grade aluminum allowing optimum corrosion protection

For integration with Applied systems,  
please refer to the Modular L, in the AHU chapter



Access all technical information on ALB-RBS at [my.daikin.eu](http://my.daikin.eu) or click here



Access all technical information on ALB-LBS at [my.daikin.eu](http://my.daikin.eu) or click here

## Technical details

D-AHU Modular L Smart		ALB-RBS/LBS	02	03	04	05	06	07
Airflow		m <sup>3</sup> /h	300	600	1200	1500	2300	3000
Heat exchanger thermal efficiency <sup>1</sup>		%	90	91	90	90	92	91
External static pressure	Nom.	Pa	100	100	100	100	100	100
Temperature after heat exchanger <sup>1</sup>	Nom.	°C	19,4	19,5	19,4	19,2	19,8	19,5
Max ESP @ nom. airflow		Pa	400	450	260	270	250	210
Current	Nom.	A	0,52	1,17	1,91	2,48	3,76	5,39
Power input	Nom.	kW	0,12	0,27	0,44	0,57	0,87	1,24
SFPv <sup>2</sup>		kW/m <sup>3</sup> /s	1,24	1,49	1,28	1,32	1,32	1,46
ERP compliant			ErP 2018 Compliant					
Electrical supply	Phase	ph	1	1	1	1	1	1
	Frequency	Hz	50/60	50/60	50/60	50/60	50/60	50/60
	Voltage	V	220/240 Vac	220/240 Vac	220/240 Vac	220/240 Vac	220/240 Vac	220/240 Vac
Main unit dimensions	Width	mm	920	1100	1600	1600	2000	2000
	Height	mm	280	350	415	415	500	500
	Length	mm	1660	1800	2000	2000	2000	2000
Rectangular duct flange	Width	mm	250	400	500	500	700	700
	Height	mm	150	200	300	300	400	400
Unit Sound Power Level (Lwa)		dB	48	54	57	53	60	57
Unit Sound Pressure Level <sup>3</sup>		dBA	34	39	41	37	44	41
Weight unit		kg	125	180	270	280	355	360

1. Winter design condition: Outdoor: -5°C, 90% Indoor: 22°C, 50%

2. SFPv is a parameter that quantifies the fan efficiency (the lower it is the better will be). This reduces if airflow decreases.

3. According to EN3744. Surrounding, Directivity (Q) = 2, @ 1,5m distance

## Electrical heater for Modular L smart

- › Total solution for fresh air with Daikin supply of both Modular L Smart and electrical heaters
- › Increase comfort in low outdoor temperature thanks to the heated outdoor air
- › Integrated electrical heater concept (no additional accessories required)
- › Standard dual flow and temperature sensor
- › Heater only consumes what is required to pre-heat to the desired minimum fresh air temperature; thus saving energy



Electrical heater for Modular L Smart (ALD)	02HEFB	03HEFB	05HEFB	07HEFB
Capacity kW	1,5	3	7,5	15
Connectable Modular L Smart size	02	03	04, 05	06, 07
Supply voltage	230V,1ph		400V,3ph	
Output current (maximum) (A)	6,6	13,1	10,9	21,7
Temperature sensor	15k ohms at -20 °C 10k ohms at +10 °C	16k ohms at -20 °C 10k ohms at +10 °C	17k ohms at -20 °C 10k ohms at +10 °C	18k ohms at -20 °C 10k ohms at +10 °C
Temperature control range	- 20 °C to 10 °C			
Control fuse	Mini Circuit Breaker 6 A			
LED indicators	"Yellow = Airflow fault Red = Heat ON"			
Mounting holes	Depends on duct size			
Maximum ambient adjacent to terminal box	30°C (during operation)			
Auto high temp. cutout	75°C Pre-set			
Man. reset high temp.cutout	120°C Pre-set			
Width (mm)	470	620	720	920
Depth (mm)	370	370	370	370
Height (mm)	193	243	343	443

# Energy reclaim ventilation

## Ventilation with heat recovery as standard

- › **NEW** Thinnest High Efficiency Enthalpy Heat Exchanger in the market (J-series)
- › Energy saving ventilation using indoor heating, cooling and moisture recovery
- › Free cooling possible when outdoor temperature is below indoor temperature (eg. during nighttime)
- › Prevent energy losses from over-ventilation while improving indoor air quality with optional CO<sub>2</sub> sensor
- › **NEW** Possibility to change ESP via wired remote control allows optimisation of the supply air volume (J - series)
- › Can be used as stand alone or integrated in the Sky Air or VRV system
- › Wide range of units: air flow rate from 150 up to 2,000 m<sup>3</sup>/h
- › Shorter installation time thanks to easy adjustment of nominal air flow rate, so less need for dampers compared with traditional installation
- › No drain piping needed
- › Can operate in over- and under pressure
- › Total solution for fresh air with Daikin supply of both VAM / VKM and electrical heaters

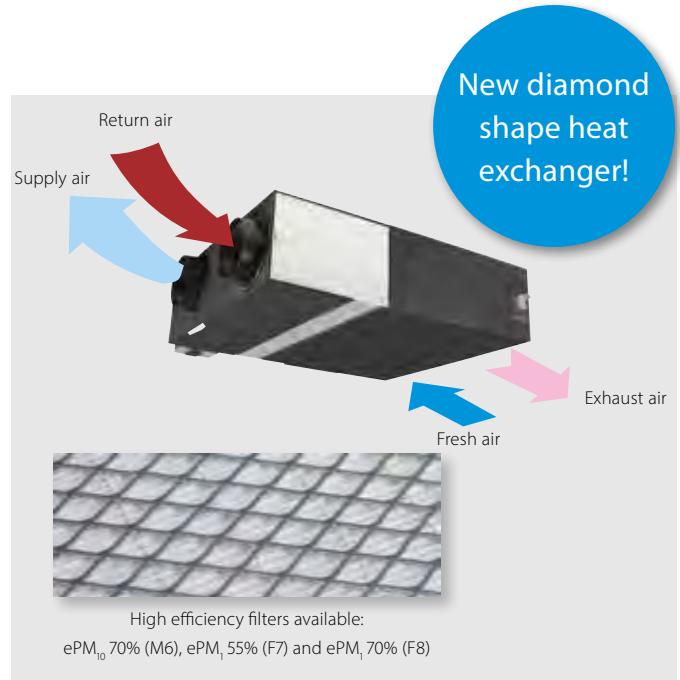

Access all technical information on VAM-FC at [my.daikin.eu](http://my.daikin.eu) or click here

Access all technical information on VAM-J at [my.daikin.eu](http://my.daikin.eu) or click here

Ventilation		VAM/VAM	150FC	250FC	350J	500J	650J	800J	1000J	1500J	2000J			
Power input - 50Hz	Heat exchange mode	Nom. Ultra high/High/Low	kW	0.132/0.111/0.058	0.161/0.079/0.064	0.097/0.070/0.039	0.164/0.113/0.054	0.247/0.173/0.081	0.303/0.212/0.103	0.416/0.307/0.137	0.548/0.384/0.191	0.833/0.614/0.273		
	Bypass mode	Nom. Ultra high/High/Low	kW	0.132/0.111/0.058	0.161/0.079/0.064	0.085/0.061/0.031	0.148/0.100/0.045	0.195/0.131/0.059	0.289/0.194/0.086	0.417/0.300/0.119	0.525/0.350/0.156	0.835/0.600/0.239		
Temperature exchange efficiency - 50Hz	Ultra high/High/Low		%	77.0(1)/72.0(2)/78.3(1)/72.3(2)/82.8(1)/73.2(2)	74.9(1)/69.5(2)/76.0(1)/70.0(2)/80.1(1)/72.0(2)	85.1/86.7/90.1	80.0/82.5/87.6	84.3/86.4/90.5	82.5/84.2/87.7	79.6/81.8/86.1	83.2/84.8/88.1	79.6/81.8/86.1		
Enthalpy exchange efficiency - 50Hz	Cooling	Ultra high/High/Low	%	60.3(1)/61.9(1)/67.3(1)	60.3(1)/61.2(1)/64.5(1)	65.2/67.9/74.6	59.2/61.8/69.5	59.2/63.8/73.1	67.7/70.7/76.8	62.6/66.4/74.0	68.9/71.8/77.5	62.6/66.4/74.0		
	Heating	Ultra high/High/Low	%	66.6(1)/67.9(1)/72.4(1)	66.6(1)/67.4(1)/70.7(1)	75.5/77.6/82.0	69.0/72.2/78.7	73.1/76.3/82.7	72.8/75.3/80.2	68.6/71.7/77.9	73.8/76.1/80.8	68.6/71.7/77.9		
Operation mode	Heat exchange mode, bypass mode, fresh-up mode													
Heat exchange system	Air to air cross flow total heat (sensible + latent heat) exchange													
Heat exchange element	Specially processed non-flammable paper													
Dimensions	Unit	HeightxWidthxDepth	mm	285x776x525		301x1,113x886		368x1,354x920	368x1,354x1,172		731x1,354x1,172			
Weight	Unit		kg	24.0		46.5		61.5	79.0		157			
Casing	Material			Galvanised steel plate										
Fan	Air flow rate - 50Hz	Heat exchange mode	Ultra high/High/Low	m <sup>3</sup> /h	150/140/105	250/230/155	350(1)/300(1)/200(1)	500(1)/425(1)/275(1)	650(1)/550(1)/350(1)	800(1)/680(1)/440(1)	1,000(1)/850(1)/550(1)	1,500(1)/1,275(1)/825(1)	2,000(1)/1,700(1)/1,100(1)	
		Bypass mode	Ultra high/High/Low	m <sup>3</sup> /h	150/140/105	250/230/155	350(1)/300(1)/200(1)	500(1)/425(1)/275(1)	650(1)/550(1)/350(1)	800(1)/680(1)/440(1)	1,000(1)/850(1)/550(1)	1,500(1)/1,275(1)/825(1)	2,000(1)/1,700(1)/1,100(1)	
		External static pressure - 50Hz	Ultra high/High/Low	Pa	90/87/40	70/63/25	90(1)/70.0/50.0(1)							
Air filter	Type			Multidirectional fibrous fleeces			Multidirectional fibrous fleeces (G3)							
Sound pressure level - 50Hz	Heat exchange mode	Ultra high/High/Low	dBA	27.0/26.0/20.5	28.0/26.0/21.0	34.5(1)/32.0(1)/29.0(1)	37.5(1)/35.0(1)/30.5(1)	39.0(1)/36.0(1)/31.0(1)	39.0(1)/36.0(1)/30.5(1)	42.0(1)/38.5(1)/32.5(1)	42.0(1)/39.0(1)/33.5(1)	45.0(1)/41.5(1)/36.0(1)		
	Bypass mode	Ultra high/High/Low	dBA	27.0/26.5/20.5	28.0/27.0/21.0	34.5(1)/32.0(1)/28.0(1)	38.0(1)/35.0(1)/29.5(1)	38.0(1)/34.5(1)/30.5(1)	40.0(1)/36.5(1)/30.5(1)	42.5(1)/40.0(1)/32.5(1)	42.0(1)/39.0(1)/32.5(1)	45.0(1)/41.0(1)/35.0(1)		
Operation range	Around unit		°CDB	-			0°C~40°CDB, 80% RH or less							
Connection duct diameter			mm	100	150	200		250		2x250				
Power supply	Phase/Frequency/Voltage		Hz/V	1~/50/60/220-240/220										
Current	Maximum fuse amps (MFA)		A	15.0				16.0						
Specific energy consumption (SEC)	Cold climate		kWh/(m <sup>2</sup> .a)	-56.0(5)	-60.5(5)	-								
	Average climate		kWh/(m <sup>2</sup> .a)	-22.1(5)	-27.0(5)	-								
	Warm climate		kWh/(m <sup>2</sup> .a)	-0.100(5)	-5.30(5)	-								
SEC class			D / See note 5	B / See note 5			-							
Maximum flow rate at 100 Pa ESP	Flow rate		m <sup>3</sup> /h	130	207	-								
	Electric power input		W	129	160	-								
Sound power level (Lwa)			dB	40	43	51	54	58	61	62	65			
Annual electricity consumption			kWh/a	18.9(5)	13.6(5)	-								
Annual heating saved	Cold climate		kWh/a	41.0(5)	40.6(5)	-								
	Average climate		kWh/a	80.2(5)	79.4(5)	-								
	Warm climate		kWh/a	18.5(5)	18.4(5)	-								

(1)Measured according to JIS B 8628 | (2)Measured at reference flow rate according to EN13141-7 | Measured according to EN308 : 1997 | In accordance with commission regulation (EU) No 1254/2014 | In accordance with commission regulation (EU) No 1253/2014 | At reference flow rate in accordance with commission regulation (EU) No 1254/2014 | Clean the filter when the filter icon appears on the controller screen. Regular filter cleaning is important for delivered air quality and for the unit's energy efficiency.

## Electrical heater for VAM

- › Total solution for fresh air with Daikin supply of both VAM and electrical heaters
- › Increased comfort in low outdoor temperature thanks to the heated outdoor air
- › Integrated electrical heater concept (no additional accessories required)
- › Standard dual flow and temperature sensor
- › Flexible setting with adjustable setpoint
- › Increased safety with 2 cut-outs: manual & automatic
- › BMS integration thanks to:
  - Volt free relay for error indication
  - 0-10VDC input for setpoint control
- › Heater only consumes what is required to pre-heat to the desired minimum fresh air temperature; thus saving energy



Electrical heater for Modular L Smart (ALD)	02HEFB	03HEFB	05HEFB	07HEFB
Capacity kW	1,5	3	7,5	15
Connectable Modular L Smart size	02	03	04, 05	06, 07
Supply voltage	230V,1ph		400V,3ph	
Output current (maximum) (A)	6,6	13,1	10,9	21,7
Temperature sensor	15k ohms at -20 °C 10k ohms at +10 °C	16k ohms at -20 °C 10k ohms at +10 °C	17k ohms at -20 °C 10k ohms at +10 °C	18k ohms at -20 °C 10k ohms at +10 °C
Temperature control range	- 20 °C to 10 °C			
Control fuse	Mini Circuit Breaker 6 A			
LED indicators	"Yellow = Airflow fault Red = Heat ON"			
Mounting holes	Depends on duct size			
Maximum ambient adjacent to terminal box	30°C (during operation)			
Auto high temp. cutout	75°C Pre-set			
Man. reset high temp.cutout	120°C Pre-set			
Width (mm)	470	620	720	920
Depth (mm)	370	370	370	370
Height (mm)	193	243	343	443

# Energy reclaim ventilation, humidification and air processing

Pre heating or cooling of fresh air for lower load on the air conditioning system

- › Energy saving ventilation using indoor heating, cooling and moisture recovery
- › Creates a high quality indoor environment by pre conditioning incoming fresh air
- › Humidification of the incoming air results in comfortable indoor humidity level, even during heating
- › Free cooling possible when outdoor temperature is below indoor temperature (eg. during nighttime)
- › Low energy consumption thanks to DC fan motor
- › Prevent energy losses from over-ventilation while improving indoor air quality with optional CO2 sensor
- › Shorter installation time thanks to easy adjustment of nominal air flow rate, so less need for dampers compared with traditional installation
- › Specially developed heat exchange element with High Efficiency Paper (HEP)
- › Can operate in over- and under pressure



VKM80-100GB(M)

 Access all technical information on VKM-GB at [my.daikin.eu](http://my.daikin.eu) or click here

 Access all technical information on VKM-GBM at [my.daikin.eu](http://my.daikin.eu) or click here

Ventilation		VKM-GB/VKM-GBM		50GB	80GB	100GB	50GBM	80GBM	100GBM	
Power input - 50Hz	Heat exchange mode	Nom.	Ultra high/High/Low	kW	0.270/0.230/0.170	0.330/0.280/0.192	0.410/0.365/0.230	0.270/0.230/0.170	0.330/0.280/0.192	0.410/0.365/0.230
	Bypass mode	Nom.	Ultra high/High/Low	kW	0.270/0.230/0.140	0.330/0.280/0.192	0.410/0.365/0.230	0.270/0.230/0.170	0.330/0.280/0.192	0.410/0.365/0.230
Fresh air conditioning load	Cooling		Ultra high/High/Low	kW	4.71 / 1.91 / 3.5	7.46 / 2.96 / 5.6	9.12 / 3.52 / 7.0	4.71 / 1.91 / 3.5	7.46 / 2.96 / 5.6	9.12 / 3.52 / 7.0
	Heating		Ultra high/High/Low	kW	5.58 / 2.38 / 3.5	8.79 / 3.79 / 5.6	10.69 / 4.39 / 7.0	5.58 / 2.38 / 3.5	8.79 / 3.79 / 5.6	10.69 / 4.39 / 7.0
Temperature exchange efficiency - 50Hz	Ultra high/High/Low			%	76/76/77.5	78/78/79	74/74/76.5	76/76/77.5	78/78/79	74/74/76.5
Enthalpy exchange efficiency - 50Hz	Cooling		Ultra high/High/Low	%	64/64/67	66/66/68	62/62/66	64/64/67	66/66/68	62/62/66
	Heating		Ultra high/High/Low	%	67/67/69	71/71/73	65/65/69	67/67/69	71/71/73	65/65/69
Operation mode	Heat exchange mode / Bypass mode / Fresh-up mode									
Heat exchange system	Air to air cross flow total heat (sensible + latent heat) exchange									
Heat exchange element	Specially processed non-flammable paper									
Humidifier	System	Natural evaporating type								
Dimensions	Unit	HeightxWidthxD	mm	387x1,764x832	387x1,764x1,214			387x1,764x832	387x1,764x1,214	
Weight	Unit		kg	94	110	112	100	119	123	
Casing	Material	Galvanised steel plate								
Fan-Air flow rate - 50Hz	Heat exchange mode	Ultra high/High/Low	m <sup>3</sup> /h	500/500/440	750/750/640	950/950/820	500/500/440	750/750/640	950/950/820	
	Bypass mode	Ultra high/High/Low	m <sup>3</sup> /h	500/500/440	750/750/640	950/950/820	500/500/440	750/750/640	950/950/820	
Fan-External static pressure - 50Hz	Ultra high/High/Low		Pa	210/170/140	210/160/110	150/100/70	200/150/120	205/155/105	110/70/60	
Air filter	Type	Multidirectional fibrous fleeces								
Sound pressure level - 50Hz	Heat exchange mode	Ultra high/High/Low	dB(A)	39/37/35	41.5/39/37	41/39/36.5	38/36/34	40/37.5/35.5	40/38/35.5	
	Bypass mode	Ultra high/High/Low	dB(A)	40/38/35.5	41.5/39/37	41/39/36.5	39/36/34.5	41/38/36	41/39/35.5	
Operation range	Around unit		°CDB	0°C~40°CDB, 80% RH or less						
	Supply air		°CDB	-15°C~40°CDB, 80% RH or less						
	Return air		°CDB	0°C~40°CDB, 80% RH or less						
	On coil temperature	Cooling/Max./Heating/Min.	°CDB	-15/43				-15/43		
Refrigerant	Control	Electronic expansion valve								
	Type	R-410A								
	GWP	2,087.5								
Connection duct diameter			mm	200	250			200	250	
Piping connections	Liquid	OD	mm	6.35						
	Gas	OD	mm	12.7						
	Water supply		mm	-						
	Drain		mm	6.4						
Power supply	Phase/Frequency/Voltage		Hz/V	PT3/4 external thread						
Current	Maximum fuse amps (MFA)		A	1~50/220-240						
				15						



# Daikin air handling units solutions

You will find your match

## Why choose Daikin air handling units with a DX connection?



### Simplifying business

The unique total solution approach by Daikin helps businesses to propose better cross-pillar solutions, to increase their success ratio by providing unmatched product combinations to the end-user and to simplify the life of installers by supplying high-quality products coming from the same manufacturer. Contrary to other manufacturers, Daikin does not use OEM products in its AHU with DX offer. Many competitors are either offering OEM DX outdoor units or OEM AHU which create additional problems when warranties or faults arise. **Having a single interface for your business makes Daikin the right choice.**

### One stop shop

Daikin is the only global manufacturer in the market **capable of offering a true Plug & Play solution** where Daikin AHUs manufactured by Daikin Applied Europe and certified by Eurovent, offer off-the-shelf compatibility with Daikin's unique VRV outdoor unit range for the best performance in the market. This unique integration of cross-pillar products under the same umbrella, gives the customer both peace-of-mind and added value when promoting a total solution approach.

### Complete range of possibilities

Thanks to the **most complete offer in the market**, Daikin has the solution for all types of commercial applications requiring fresh air. Daikin provides ventilation solutions based on AHU from 2,500 m<sup>3</sup>/h up to 140,000 m<sup>3</sup>/h either with natural heat recovery or more advanced ventilation solutions where a VRV outdoor unit can be connected to the Daikin AHU for ultimate climate control. The harmonized control between the VRV outdoor unit and the AHU offer outstanding 24h/7 control of the system when connected to an iTM.

## Advantages

- › Unique manufacturer offering a complete range
- › Plug & Play solution
- › Direct iTM compatibility

## Why use VRV and ERQ condensing units for connection to air handling units?

### High Efficiency

Daikin heat pumps are renowned for their high energy efficiency. Integrating the AHU with a heat recovery system is even more effective since an office system can frequently be in cooling mode while the outdoor air is too cold to be brought

inside in an unconditioned state. In this case heat from the offices is merely transferred to heat up the cold incoming fresh air.

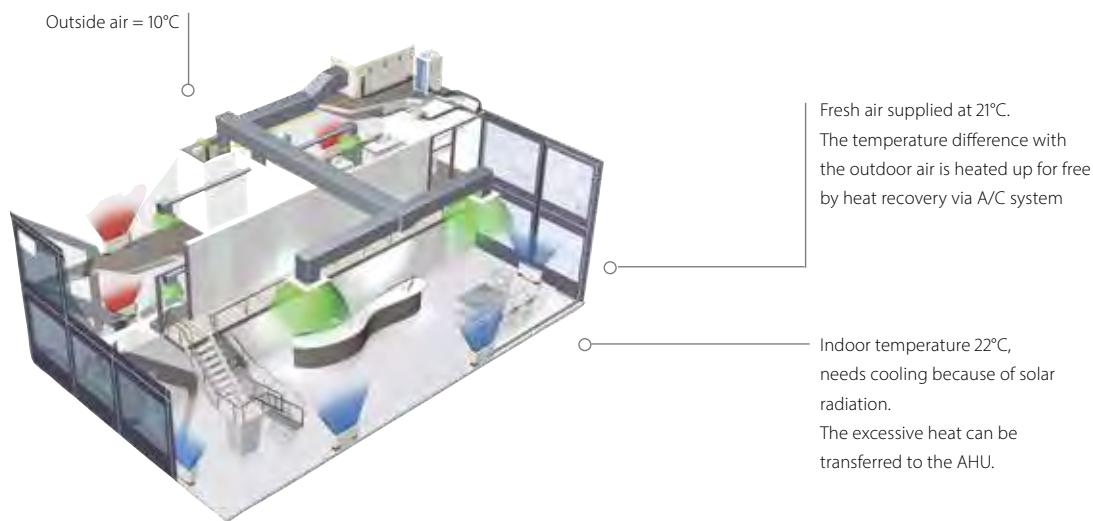

### Fast response to changing loads resulting in high comfort levels

Daikin ERQ and VRV units respond rapidly to fluctuations in supply air temperature, resulting in a steady indoor temperature and resultant high comfort levels for the end user. The ultimate is the VRV range which improves comfort even more by offering continuous heating, also during defrost.

### Easy Design and Installation

The system is easy to design and install since no additional water systems such as boilers, tanks and gas connections etc. are required. This also reduces both the total system investment and running cost.

### Daikin Fresh air package

- › Plug & Play connection between VRV/ERQ and the entire D-AHU modular range.
- › Factory fitted and welded control and expansion valve kits.

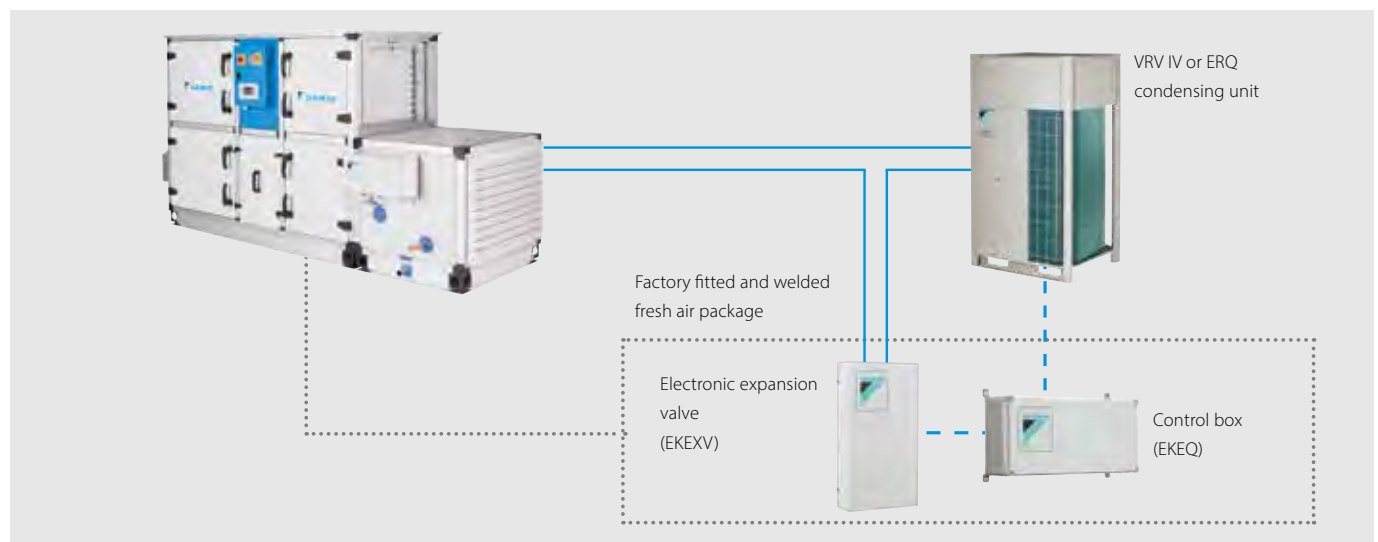

## In order to maximise installation flexibility, 4 types of control systems are offered

**W control:** Off the shelf control of air temperature (discharge temperature, suction temperature, room temperature) via any DDC controller, easy to setup

**X control:** Precise control of air temperature (discharge temperature, suction temperature, room temperature) requiring a preprogrammed DDC controller (for special applications)

**Z control:** Control of air temperature (suction temperature, room temperature) via Daikin control (no DDC controller needed)

**Y control:** Control of refrigerant ( $T_e/T_c$ ) temperature via Daikin control (no DDC controller needed)

### 1. W control ( $T_s/T_r/T_{ROOM}$ control):

#### Air temperature control via DDC controller

Room temperature is controlled as a function of the air handling unit suction or discharge air (customer selection). The DDC controller is translating the temperature difference between set point and air suction temperature (or air discharge temperature or room temperature) into a proportional 0-10V signal which is transferred to the Daikin control box (EKEQFCBA). This voltage modulates the capacity requirements of the outdoor unit.

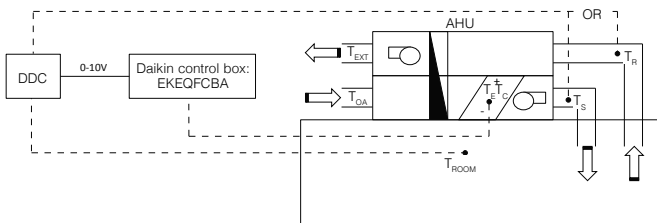

### 2. X control ( $T_s/T_r/T_{ROOM}$ control):

#### Precise air temperature control via DDC controller

Room temperature is controlled as a function of the air handling unit suction or discharge air (customer selection). The DDC controller is translating the temperature difference between set point and air suction temperature (or air discharge temperature or room temperature) into a reference voltage (0-10V) which is transferred to the Daikin control box (EKEQFCBA). This reference voltage will be used as the main input value for the compressor frequency control.

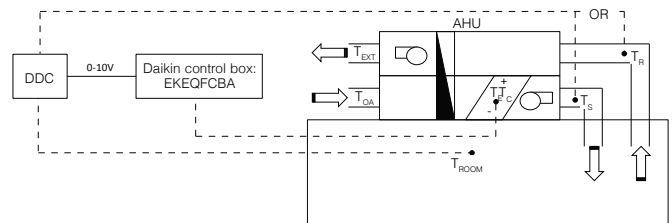

### 3. Y control ( $T_e/T_c$ control):

#### By fixed evaporating /condensing temperature

A fixed target evaporating or condensing temperature can be set by the customer. In this case, room temperature is only indirectly controlled. A Daikin wired remote control (BRC1\* - optional) have to be connected for initial set-up but not required for operation.

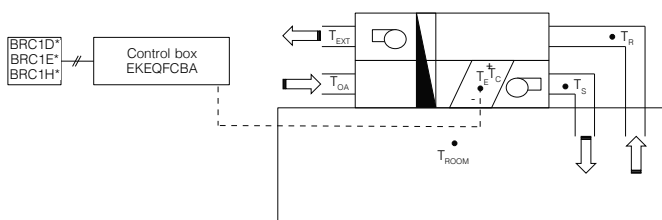

### 4. Z control ( $T_s/T_{ROOM}$ control):

#### Control your AHU just like a VRV indoor unit with 100% fresh air

Allows the possibility to control the AHU just like a VRV indoor unit. Meaning temperature control will be focused on return air temperature from the room into the AHU. Requires BRC1\* for operation. The only control that allows the combination of other indoor units to the AHU at the same time.

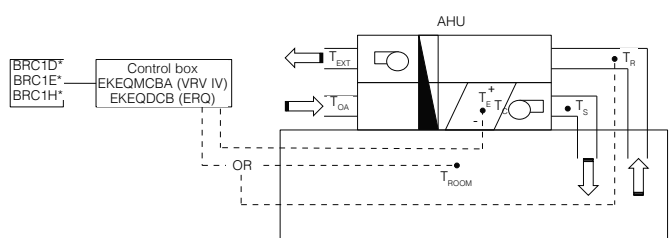

$T_s$ = Supply air temperature	$T_r$ = Return air temperature	$T_{OA}$ = Outdoor air temperature	$T_{ROOM}$ = Room air temperature
$T_{EXT}$ = Extraction air temperature	$T_e$ = Evaporating temperature	$T_c$ = Condensing temperature	

	Option kit	Features
Possibility W	EKEQFCBA	Off-the-shelf DDC controller that requires no pre-configuration
Possibility X		Pre-configured DDC controller required
Possibility Y		Using fixed evaporating temperature, no set point can be set using remote control
Possibility Z	EKEQDCB EKFQMCBA*	Using Daikin infrared remote control BRC1* Temperature control using air suction temperature or room temperature (via remote sensor)

\* EKEQMCB (for 'multi' application)

# VRV - for larger capacities (from 8 to 54HP)

## An advanced solution for both pair and multi application

- > Inverter controlled units
- > Heat recovery, heat pump
- > R-410A
- > Control of room temperature via Daikin control
- > Large range of expansion valve kits available
- > BRC1H519W/S/K is used to set the set point temperature (connected to the EKEQMCBA).
- > Connectable to all VRV heat recovery and heat pump systems

### W, X, Y control for VRV IV heat pump

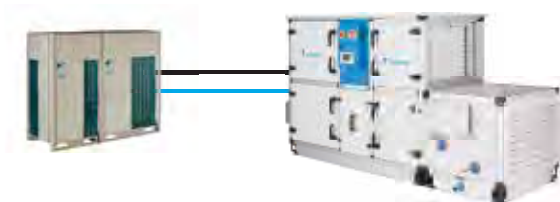

### Z control for all VRV outdoor units

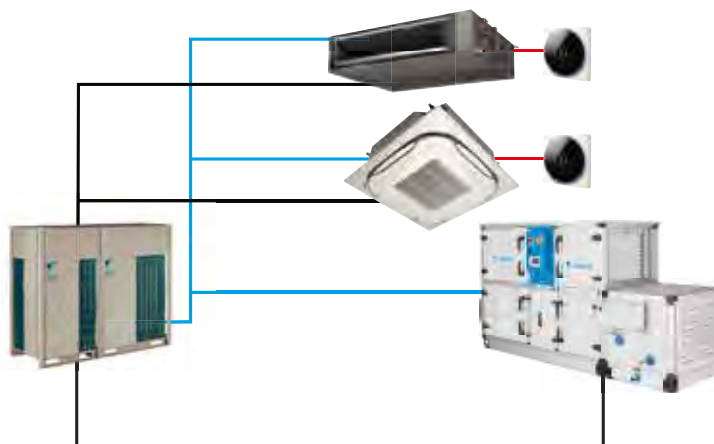

- Refrigerant piping
- F1-F2
- P1-P2



## ERQ - for smaller capacities (from 100 to 250 class)

### A basic fresh air solution for pair application

- › Inverter controlled units
- › Heat pump
- › R-410A
- › Wide range of expansion valve kits available
- › Perfect for the Daikin Modular air handling unit

The "Daikin Fresh Air Package" provides a complete Plug & Play Solution including AHU, ERQ or VRV Condensing Unit and all unit control (EKEQ, EKEX, DDC controller) factory mounted and configured. The easiest solution with only one point of contact.



ERQ-AW1



Access all technical information on ERQ-AV1 at [my.daikin.eu](http://my.daikin.eu) or click here



Access all technical information on ERQ-AW1 at [my.daikin.eu](http://my.daikin.eu) or click here

Ventilation				ERQ	100AV1	125AV1	140AV1
Capacity range				HP	4	5	6
Cooling capacity	Nom.			kW	11.2	14.0	15.5
Heating capacity	Nom.			kW	12.5	16.0	18.0
Power input	Cooling	Nom.		kW	2.81	3.51	4.53
	Heating	Nom.		kW	2.74	3.86	4.57
EER						3.99	3.42
COP					4.56	4.15	3.94
Dimensions	Unit	HeightxWidthxDepth	mm		1,345x900x320		
Weight	Unit		kg		120		
Casing	Material				Painted galvanized steel plate		
Fan-Air flow rate	Cooling	Nom.	m <sup>3</sup> /min		106		
	Heating	Nom.	m <sup>3</sup> /min	102		105	
Sound power level	Cooling	Nom.	dBA	66		67	69
Sound pressure level	Cooling	Nom.	dBA	50		51	53
	Heating	Nom.	dBA	52		53	55
Operation range	Cooling	Min./Max.	°CDB			-5/46	
	Heating	Min./Max.	°CWB			-20/15.5	
	On coil temperature	Heating/Min./Cooling/Max.	°CDB			10/35	
Refrigerant	Type					R-410A	
	Charge		kg			4.0	
			TCO <sub>2</sub> eq			8.4	
	GWP					2,087.5	
Piping connections	Control					Expansion valve (electronic type)	
	Liquid	OD	mm			9.52	
	Gas	OD	mm		15.9		19.1
	Drain	OD	mm			26x3	
Power supply	Phase/Frequency/Voltage		Hz/V		1N~/50/220-240		
Current	Maximum fuse amps (MFA)		A		32.0		

Ventilation				ERQ	125AW1	200AW1	250AW1
Capacity range				HP	5	8	10
Cooling capacity	Nom.			kW	14.0	22.4	28.0
Heating capacity	Nom.			kW	16.0	25.0	31.5
Power input	Cooling	Nom.		kW	3.52	5.22	7.42
	Heating	Nom.		kW	4.00	5.56	7.70
EER					3.98	4.29	3.77
COP					4.00	4.50	4.09
Dimensions	Unit	HeightxWidthxDepth	mm		1,680x635x765		1,680x930x765
Weight	Unit		kg		159	187	240
Casing	Material				Painted galvanized steel plate		
Fan-Air flow rate	Cooling	Nom.	m <sup>3</sup> /min	95		171	185
	Heating	Nom.	m <sup>3</sup> /min	95		171	185
Sound power level	Nom.		dBA	72			78
Sound pressure level	Nom.		dBA	54		57	58
Operation range	Cooling	Min./Max.	°CDB			-5/43	
	Heating	Min./Max.	°CWB			-20/15	
	On coil temperature	Heating/Min./Cooling/Max.	°CDB			10/35	
Refrigerant	Type					R-410A	
	Charge		kg		6.2	7.7	8.4
			TCO <sub>2</sub> eq		12.9	16.1	17.5
	GWP					2,087.5	
Piping connections	Control					Electronic expansion valve	
	Liquid	OD	mm			9.52	
	Gas	OD	mm		15.9	19.1	22.2
	Power supply	Phase/Frequency/Voltage		Hz/V		3N~/50/400	
Current	Maximum fuse amps (MFA)		A		16		25

# Integration of ERQ and VRV in third party air handling units

a wide range of expansion valve kits and control boxes

## Combination table

	Control box			Expansion valve kit										Mixed connection with VRV indoor units	
	EKEQDCB	EKEQFCBA	EKEQMCBA	EKE XV50	EKE XV63	EKE XV80	EKE XV100	EKE XV125	EKE XV140	EKE XV200	EKE XV250	EKE XV400	EKE XV500		
	Z control	W,X,Y control	Z control	-	-	-	-	-	-	-	-	-	-	-	
1-phase	ERQ100	P	P	-	-	P	P	P	P	-	-	-	-	-	
	ERQ125	P	P	-	-	P	P	P	P	-	-	-	-	-	
	ERQ140	P	P	-	-	P	P	P	P	-	-	-	-	-	
3-phase	ERQ125	P	P	-	-	P	P	P	P	-	-	-	-	-	
	ERQ200	P	P	-	-	-	-	P	P	P	P	-	-	-	
	ERQ250	P	P	-	-	-	-	P	P	P	P	-	-	-	
	VRV III	-	-	n1	n1	n1	n1	n1	n1	n1	n1	n1	n1	n1	Mandatory
	VRV IV H/P / VRV IV W-series / VRV IV S-series	-	P (1 -> 3)	n2	n2	n2	n2	n2	n2	n2	n2	n2	n2	n2	Possible (not mandatory)
	VRV IV H/R / VRV IV i-series	-	n1	-	n1	n1	n1	n1	n1	n1	n1	n1	n1	n1	Mandatory

- P (pair application): combination depends on the capacity of the air handling unit
- n1 (multi application) - Combination of AHUs and VRV DX indoors (mandatory). To determine the exact quantity please refer to the engineering data book.
- n2 (multi application) - Combination of AHUs and VRV DX indoors (not mandatory). To determine the exact quantity please refer to the engineering data book.
- Control box EKEQFA can be connected to some types of VRV IV outdoor units (with a maximum of 3 boxes per unit). Do not combine EKEQFA control boxes with VRV DX indoor units, RA indoor units or hydroboxes

## Capacity table

### Cooling

EKE XV Class	Allowed heat exchanger capacity (kW)			Allowed heat exchanger volume (dm <sup>3</sup> )	
	Minimum	Standard	Maximum	Minimum	Maximum
50	5.0	5.6	6.2	1.33	1.65
63	6.3	7.1	7.8	1.66	2.08
80	7.9	9.0	9.9	2.09	2.64
100	10.0	11.2	12.3	2.65	3.30
125	12.4	14.0	15.4	3.31	4.12
140	15.5	16.0	17.6	4.13	4.62
200	17.7	22.4	24.6	4.63	6.60
250	24.7	28.0	30.8	6.61	8.25
400	35.4	45.0	49.5	9.26	13.2
500	49.6	56.0	61.6	13.2	16.5

Saturated evaporating temperature: 6°C  
Air temperature: 27°C DB / 19°C WB

### Heating

EKE XV Class	Allowed heat exchanger capacity (kW)			Allowed heat exchanger volume (dm <sup>3</sup> )	
	Minimum	Standard	Maximum	Minimum	Maximum
50	5.6	6.3	7.0	1.33	1.65
63	7.1	8.0	8.8	1.66	2.08
80	8.9	10.0	11.1	2.09	2.64
100	11.2	12.5	13.8	2.65	3.30
125	13.9	16.0	17.3	3.31	4.12
140	17.4	18.0	19.8	4.13	4.62
200	19.9	25.0	27.7	4.63	6.60
250	27.8	31.5	34.7	6.61	8.25
400	39.8	50.0	55.0	9.26	13.2
500	55.1	63.0	69.3	13.2	16.5

Saturated condensing temperature: 46°C  
Air temperature: 20°C DB

## EKE XV - Expansion valve kit for air handling applications

Ventilation		EKE XV	50	63	80	100	125	140	200	250	400	500
Dimensions	Unit	mm	401x215x78									
Weight	Unit	kg	2.9									
Sound pressure level	Nom.	dBA	45									
Operation range	On coil	Heating Min.	°CDB									
	temperature	Cooling Max.	°CDB									
Refrigerant	Type / GWP		R-410A / 2.087,5									
Piping connections	Liquid	OD	mm	6.35	9.52						12.7	15.9

(1) The temperature of the air entering the coil in heating mode can be reduced to -5°CDB. Contact your local dealer for more information. (2) 45% Relative humidity.

## EKEQ - Control box for air handling applications

Ventilation		EKEQ	FCBA	DCB	MCBA
Application			See note	Pair	Multi
Outdoor unit			ERQ / VRV	ERQ	VRV
Dimensions	Unit	mm	132x400x200		
Weight	Unit	kg	3.9	3.6	
Power supply	Phase/Frequency/Voltage	Hz/V	1~/50/230		

The combination of EKEQFCBA and ERQ is in pair application. The EKEQFCBA can be connected to some type of VRV IV outdoor units with a maximum of 3 control boxes. The combination with DX indoor units, hydroboxes, RA outdoor units, ... is not allowed. Refer to the combination table drawing of the outdoor unit for details.

## Pair application selection

- › **the outdoor unit is connected to ONE COIL (with single circuit or maximum 3 interlaced circuits) using up to 3 control boxes**
- › **indoor unit combination is not allowed**
- › **only works with X, W, Y control**

### Step 1: Required AHU capacity

An AHU with double flow, heat recovery and 100% fresh air is to be installed in Europe where the outdoor sizing temperature is 35 °CDB and the target supply air temperature for fresh air is 25 °CDB. Load calculations point to a required capacity of 45kW. By checking on the EKEXV capacity table, for cooling operation, 40kW falls within the 400 class valve. Since 40kW is not the nominal capacity, a class adjustment has to be done.  $40/45=0,89$  and  $0,89 \times 400=356$ . So the capacity class of the expansion valve kit is 356.

### Step 2: Outdoor unit selection

For this AHU, a VRV IV heat pump model with continuous heating is going to be used (RYYQ-T series). For a capacity of 40kW at 35 °CDB, an outdoor of 14HP (RYYQ14T) is selected. The capacity class of the 14 HP outdoor unit is 350. Total connection ratio of the system is  $356/350=102\%$  hence it falls within the range 90-110%.

### Step 3: Control box selection

In this particular case, the control will work with precise air temperature control. Only W or X control allow this. Since the consultant wants to use an "off-the-shelf" DDC module, the EKEQFCBA box with W control allows easy set-up due to pre-set factory values.

## Multi application selection

- › **the outdoor unit can be connected to MULTIPLE COILS (and their control boxes)**
- › **indoor units are also connectable but not mandatory**
- › **only works with Z control**

### Step 1: Required AHU capacity

An AHU with double flow, heat recovery and 100% fresh air is to be installed in Europe where the outdoor sizing temperature is 35 °CDB and the target supply air temperature for fresh air is 25 °CDB. On top of this, for this building, 5 round-flow cassette units FXFQ50A will also be connected to this OU. Load calculations point to a required capacity of 20kW for the AHU and 22,5 kW for the indoor units. By checking on the EKEXV capacity table, for cooling operation, 20kW falls within the 200 class valve. Since 22,4 kW is the nominal capacity, a class adjustment has to be done.  $20/22,4=0,89$  and  $0,89 \times 200=178$ . So the capacity class of the expansion valve kit is 178. Total capacity class of the indoor unit system is  $178+250=428$

### Step 2: Outdoor unit selection

For this system where a AHU is connected with indoor units, it is mandatory to use a heat recovery unit. By consulting the engineering databook for REYQ-T, the total required capacity of 42,5 kW requires a 16HP model REYQ16T. Which will deliver 45kW at the design temperature of 35 °CDB. This unit has a capacity class of 400. Total connection ratio of the system is  $428/400=107\%$  hence it falls within the range 50-110%.

### Step 3: Control box selection

In this particular case, the only available control is Z control and the combination of AHU and VRV DX indoor units requires EKEQMCBA control box.



# Hello Madoka.

The beauty of simplicity

## Madoka guarantees comfort in the most intuitive way imaginable

Available in three attractive colours, Madoka adds style and class to any interior space.

Measuring just 85 x 85 mm, Madoka is extremely compact and will become a fluid part of any background.

Madoka combines refinement and simplicity.

The intuitive touch button control enlarges the display and makes Madoka both easy and enjoyable to use.

The Madoka Assistant app simplifies the advanced settings such as schedule or set point limitation. Your smartphone connects easily with Madoka via Bluetooth®

White  
RAL 9003 (glossy)



Silver  
RAL 9006 (metallic)



Black  
RAL 9005 (matt)



reddot award 2018  
winner



[www.daikin.eu/madoka](http://www.daikin.eu/madoka)



# Control Systems

Application overview	162
<hr/>	
Individual control systems	
Online controller	164
Wired / infrared remote controls	166
<hr/>	
Centralised control systems	
Centralised remote control / Unified ON/OFF control / Schedule timer	170
<b>Intelligent Controller</b>	171
<b>Intelligent Controller</b> with Daikin Cloud Service	172
<b>Intelligent Manager</b>	174
<hr/>	
Standard protocol interfaces	
Modbus interface	178
KNX Interface	181
<b>PMS Interface</b> for hotels	182
<b>BACnet Interface</b>	183
<b>LonWorks Interface</b>	184
<hr/>	
Daikin Configurator Software EKPCAB3	185
<hr/>	
Daikin Cloud Service for commercial DX systems	
<hr/>	
Other devices	
Wireless room temperature sensor	188
Wired room temperature sensor	188
Other integration devices	189

New online controller for Sky Air



New premium design wired remote control



DAIKIN CLOUD SERVICE







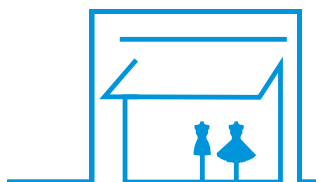

# Control solutions summary

Daikin offers various control solution adapted to the requirements of even the most demanding commercial application.

- > Basic control solutions for those customers with few requirements and limited budget
- > Integrating control solutions for those customers that would like to integrate Daikin units into their existing BMS system
- > Advanced control solutions for those customers that expect Daikin to deliver a mini BMS solution, including advanced energy management

## Shop





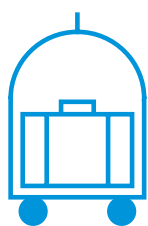

	Unit control			Integrating control			Advanced control	
								
	BRP069* Online controller	BRC519W/S/K(7)	RTD-20	RTD-Net	KLIC-DI	EKMBOXA	DCC601A51	DCM601A51
	Smart phone control for up to 50 indoor units	1 remote controller for 1 indoor unit (group)	1 gateway for 1 indoor unit (group)	1 gateway for 1 indoor unit (group)	1 gateway for 1 indoor unit	1 gateway for max. 64 indoor unit(s) (groups) & 10 outdoors	1 unit for 32 indoor unit(s) (5)	1 iTM for 64 indoor unit(s) (groups) (1)
Automatic control of A/C	●	●	●	●	●	●	●	●
Limit control possibilities for shop staff		●	●	●	●	●	●	●
Create zones within the shop			●				●	●
Interlock with eg. Alarm, PIR sensor			●				● (limited)	●
Integrate Daikin units into existing BMS via Modbus				●		●		
Integrate Daikin units into existing BMS via KNX					●			
Integrate Daikin units into existing BMS via HTTP								●
Monitor energy consumption		● (4)					● (2)	●
Advanced energy management							● (2)	●
Allows free cooling							●	●
Integrate Daikin products cross pillars into Daikin BMS								●
Integrate third party products into Daikin BMS							●	●
Online control	●						● (2)	● (3)
Manage multiple sites							● (2)	● (3)

(1) 7 iTM plus adapters (DCM601A52) can be added to have 512 indoor groups and 80 outdoor (systems) (2) Via Daikin cloud service (3) Through own IT set-up (not Daikin cloud server) (4) Not available on all indoors (5) Up to 10 DCC601A51 can be combined as a single site on Daikin Cloud Service

## Hotel



	Unit control	Integrating control		Advanced control	
					
	BRC519W/S/K(7)	RTD-HO	KLIC-DI	DCM010A51	
	1 remote controller for 1 indoor unit (group)	1 gateway for 1 indoor unit (group)	1 gateway for 1 indoor unit	1 interface for up to 2,500 indoor units	1 iTM for 64 indoor unit(s) (groups) (1)
Hotel guest can control & monitor basic functionalities from his room	●	●	● (3)		●
Limit control possibilities for hotel guests	●	●	●	●	●
Interlock with window contact	● (2)	●	●		●
Interlock with key-card	● (2)	●	●		●
Integrate Daikin units into existing BMS via Modbus		●			
Integrate Daikin units into existing BMS via KNX			●		
Integrate Daikin units into existing BMS via HTTP					●
Integrate Daikin unit control in hotel booking software				● Oracle Opera PMS	
Monitor energy consumption					●
Advanced energy management					●
Integrate Daikin products cross pillars into Daikin BMS					●
Integrate third party products into Daikin BMS					●
Online control					●

(1) : 7 iTM plus adapters (DCM601A52) can be added to have 512 indoor groups and 80 outdoor (systems) (2) Via BRP7A51 adapter (3) requires KNX compatible controller

## Office



	Unit control	Integrating control			Advanced control	
	BRC519W/S/K(7)	EKMBDXA	DMS504B51	DMS502A51 / DAM412B51	DCC601A51	DCM601A51
	1 remote controller for 1 indoor unit (group)	1 gateway for max. 64 indoor unit(s) (groups) & 10 outdoors	1 gateway for 64 indoor unit(s) (groups)	1 gateway for 128 indoor unit(s) (groups), 20 outdoors (2)	1 unit for 32 indoor unit(s) (groups) (5)	1 iTM for 64 indoor unit(s) (groups) (1)
Automatic control of A/C	●	●	●	●	●	●
Centralised control for management		●	●	●	●	●
Local control for office workers	●	●	●	●	●	●
Limit control possibilities for office workers	●				●	●
Integrate Daikin units into existing BMS via Modbus		●				
Integrate Daikin units into existing BMS via HTTP					●	●
Integrate Daikin units into existing BMS via LonTalk			●			
Integrate Daikin units into existing BMS via BACnet				●		
Energy consumption read out	●					
Monitor energy consumption					● (4)	●
Advanced energy management					● (4)	●
Integrate Daikin cross pillar products into Daikin BMS						●
Integrate third party products into Daikin BMS					●	●
Online control					● (4)	●
Manage multiple sites					● (4)	● (5)

(1) 7 iTM plus adapters (DCM601A52) can be added to have 512 indoor groups and 80 outdoor (systems) (2) extension needed to go to 256 indoor unit(s) (groups), 40 outdoors (3) ON/OFF only (4) Via Daikin cloud service (5) Through own IT set-up (not Daikin cloud sever) (5) Up to 10 DCC601A51 can be combined as a single site on Daikin Cloud Service

## Infrastructure cooling



	Unit	Integrating		Advanced
	BRC519W/S/K(7)	RTD-10	DTA113B51	DCM601A51
	1 remote controller for 1 indoor unit (group) (2)	1 gateway for 1 indoor unit (group) Up to 8 gateways can be linked together	1 adapter for op to 4 units	1 iTM for 64 indoor unit(s) (groups) (1)
Automatic control of A/C	●	●	●	●
Back-up operation	●	●	●	●
Duty rotation	●	●	●	●
Limit control possibilities in the technical cooling room	●	●		●
If room temperature above max., then show alarm & start standby unit.		●		●
If an error occurs, an alarm will be shown.	●	●		●
If an error occurs, activate an alarm output	Via KRP2/4A option (3)	●		Via WAGO I/O

(1) : 7 iTM plus adapters (DCM601A52) can be added to have 512 indoor groups and 80 outdoor (systems) (2) Infrastructure cooling functions only compatible with indoor units connected to Seasonal Smart outdoor units. (3) See option list of indoor unit

# Madoka

The beauty of simplicity.



Silver  
RAL 9006 (metallic)  
BRC1H519S(7)



Black  
RAL 9005 (matt)  
BRC1H519K(7)



White  
RAL9003 (glossy)  
BRC1H519W(7)

## User-friendly wired remote controller with premium design

Madoka combines refinement and simplicity

- › Sleek and elegant design
- › Intuitive touch-button control
- › Two display options: standard and detailed
- › Three colours to match any interior
- › Compact, measures only 85 x 85 mm
- › Advanced settings and commissioning via smartphone



reddot award 2018  
winner



DESIGN  
AWARD  
2018



# Madoka Assistant



Simplifies the advanced settings such as schedule or set point limitation

- Visual interface simplifies advanced settings such as schedule setting, energy saving activation, setting restrictions, etc.
- Easy and quick commissioning, saves time and cost for installers
- Featuring Bluetooth® low energy technology

Easy setting of schedules

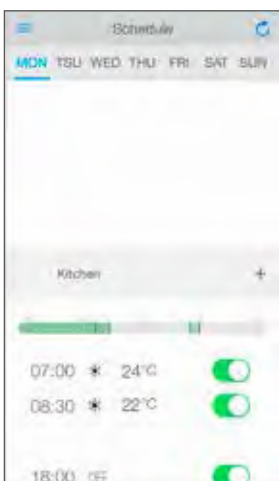

Advanced user settings



Installer settings

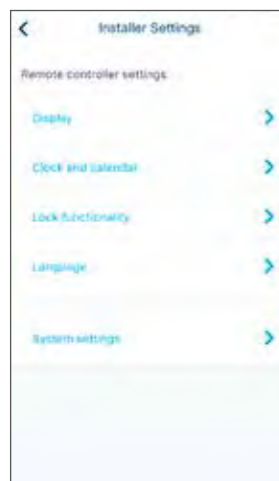

Field settings



BRC1H519W(7) / BRC1H519S(7) / BRC1H519K(7)

## Madoka wired remote controller for Sky Air and VRV



BRC1H519W(7)



BRC1H519S(7)



BRC1H519K(7)

### A complete redesigned controller focussed to enhance user experience

- > Sleek and elegant design
- > Intuitive touch-button control
- > Two display options: standard and detailed
- > Direct access to basic functions (on/off, set point, mode, target values, fan speed, louvres, filter icon & reset (4), error & code)
- > Three colours to match any interior
- > Compact, measures only 85 x 85 mm
- > Real time clock with auto update to daylight saving time
- > Equipped with a buzzer

### Hotel application features

- > Energy saving through key card, window contact integration and set point limitation (BRP7A\*)
- > Flexible setback function ensures room temperature remains within comfortable limits to ensure guest comfort

### Key card and window contact integration

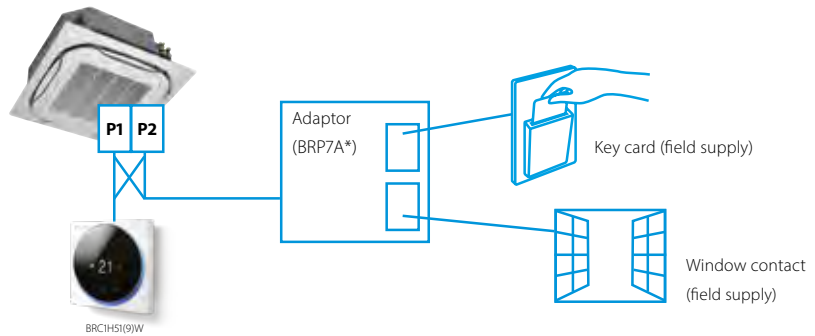

### Madoka Assistant: Advanced settings can be easily done via your smartphone

#### A range of energy-saving functions that can be selected individually

- Temperature range restriction
  - > Setback function
  - > Adjustable presence detector and floor sensor (available on the Round Flow and Fully Flat Cassettes)
  - > Automatic temperature reset (4)
  - > Auto off timer

#### Temperature range restriction means no excessive heating/cooling

Save on energy by setting the low-temperature limit in cooling mode and

the high-temperature limit in heating mode. (1) **Kilowatt-hour consumption tracking (2)**

The kWh indicator displays indicative power consumption for the last day/month/year. (4)

#### Other functions

- > Up to three independent schedules can be programmed, allowing you to switch easily between them throughout the year (e.g. summer/winter/mid-season)
- > Menu settings can be individually locked or restricted
- > The outdoor unit (3) can be set to quiet mode
- > Real-time clock that updates automatically for daylight saving



### Cost-effective solution for infrastructure cooling applications

- > Only in combination with RZAG\* / RZQG\*
- > Duty rotation

After a certain period of time, the operating unit will go into standby and the standby unit will take over, extending the system lifetime. Rotation interval can be set for 6, 12, 24, 72 or 96 hours, as well as weekly.

- > Back-up operation: if one unit fails, the other unit will start automatically

(1) Also available in auto cooling/heating changeover mode  
 (2) For Sky Air FBA, FCAG and FCAHG pair combinations only

(3) Only available on RZAG\*, RZASG\*, RZQG\*, RZQSG\*

(4) Feature will become available with future app updates from the second half of 2018 onwards.



[www.daikin.eu/madoka](http://www.daikin.eu/madoka)

BRC1E53A/B/C

## User friendly remote control for Sky Air and VRV



Graphical display of indicative electricity consumption (Function available in combination with FBA-A, FCAG and FCAHG)

### A series of energy saving functions that can be individually selected

- › Demand control (1)
- › Temperature range limit
- › Setback function
- › Presence & floor sensor connection (available on round flow and fully flat cassette)
- › kWh indication (2)
- › Set temperature auto reset
- › Off timer

### Other functions

- › Up to 3 independent schedules
- › Possibility to individually restrict menu functions
- › Choice of display between symbol or text
- › Real time clock with auto update to daylight saving time
- › Built-in backup power
- › Supports multiple languages:
  - BRC1E53A: English, German, French, Dutch, Spanish, Italian, Portuguese
  - BRC1E53B: English, Czech, Croatian, Hungarian, Romanian, Slovenian, Bulgarian
  - BRC1E53C: English, Greek, Russian, Turkish, Polish, Slovak, Albanian



### Cost-effective solution for infrastructure cooling applications

- › Only in combination with Sky Air A-series or Seasonal Smart outdoor unit

(1) Only available on RZAG\*, RZASG\*, RZQG\*, RZQSG\*  
 (2) For Sky Air FBA, FCAG and FCAHG pair combinations only

BRC2E52C / BRC3E52C

## Simplified wired remote control developed for hotel applications



BRC2E52C

With operation mode selector

- › Symbol driven interface for intuitive control
- › Functions restricted to basic customer needs
- › Energy saving through key card, window contact integration and set point limitation (BRP7A\*)
- › Flexible setback function ensures room temperature remains within comfortable limits to

- ensure guest comfort
- › Flat backpanel for easy installation
- › Easy commissioning: intuitive interface for advanced menu settings
- › 2 versions available:
  - BRC3E52C: temperature, fan speed, ON/OFF
  - BRC2E52C: temperature, mode, fan speed, ON/OFF

BRC1D52

## Wired remote control



BRC1D52

- › Schedule timer: Five day actions can be set
- › Home leave (frost protection): during absence, the indoor temperature can be maintained at a certain level. This function can also switch the unit ON/OFF
- › User friendly HRV function, thanks to the introduction of a button for ventilation mode and fan speed
- › Immediate display of fault location and condition
- › Reduction of maintenance time and costs



AZCE6BLUEFACECB / AZCE6THINKRB / AZCE6LITERB

## Controls for multi zoning kits

3 controller versions are available to choose from: Colour, touch or simplified



AZCE6BLUEFACECB

### Blueface - main thermostat

- › Intuitive graphical, colour touch screen for controlling multiple zones
- › Wired communication
- › Optional bus cable (2 x 0.5 mm<sup>2</sup> + 2 x 0.22 mm<sup>2</sup>) (10m cable length)



AZCE6THINKRB

### Think - zone thermostat

- › Graphic touch button with low-energy e-ink screen for controlling single zones
- › Low energy radio communication with proprietary protocol (868MHz)



AZCE6LITERB

### Lite - zone thermostat

- › Simplified thermostat with touch buttons for temperature control
- › Low energy radio communication with proprietary protocol (868MHz)

\* The wired Daikin BRC1E / BRC1H remote control is needed to control operation and maintenance.

ARC4\*/BRC4\*/BRC7\*

## Infrared remote control



ARC466A1

BRC4\*/BRC7\*

Operation buttons: ON/OFF, timer mode start/stop, timer mode on/off, programme time, temperature setting, air flow direction (1), operating mode, fan speed control, filter sign reset (2), inspection (2)/test indication (2)

Display: Operating mode, battery change, set temperature, air flow direction (1), programmed time, fan speed, inspection/test operation (2)

1. Not applicable for FXDQ, FXSQ, FXNQ, FBDQ, FDXM, FBA
2. For FX\*\* units only
3. For all features of the remote control, refer to the operation manual

## Centralised control systems

Centralised control of the Sky Air and VRV system can be achieved via 3 user friendly compact remote controllers. These controls may be used independently or in combination with:

1 group = several (up to 16) indoor units in combination

1 zone = several groups in combination.

A centralised remote control is ideal for use in tenanted commercial buildings subject to random occupation, enabling indoor units to be classified in groups per tenant (zoning).

The schedule timer programmes the schedule and operation conditions for each tenant and the control can easily be reset according to varying requirements.

### DCS302C51

## Centralised remote control



Providing individual control of 64 groups (zones) of indoor units.

- › a maximum of 64 groups (128 indoor units, max. 10 outdoor units) can be controlled
- › a maximum of 128 groups (128 indoor units, max. 10 outdoor units) can be controlled via 2 centralised remote controls in separate locations
- › zone control
- › group control
- › malfunction code display
- › maximum wiring length of 1,000m (total: 2,000m)
- › air flow direction and air flow rate of HRV can be controlled
- › expanded timer function

### DST301B51

## Schedule timer



Enabling 64 groups to be programmed.

- › a maximum of 128 indoor units can be controlled
- › 8 types of weekly schedule
- › a maximum of 48 hours back up power supply
- › a maximum wiring length of 1,000m (total: 2,000m)

### DCS301B51

## Unified ON/OFF control



Providing simultaneous and individual control of 16 groups of indoor units.

- › a maximum of 16 groups (128 indoor units) can be controlled
- › 2 remote controls in separate locations can be used
- › operating status indication (normal operation, alarm)
- › centralised control indication
- › maximum wiring length of 1,000m (total: 2,000m)

# Intelligent touch Controller

## DCS601C51

Detailed & easy monitoring and operation of VRV systems (max. 64 indoor units groups).

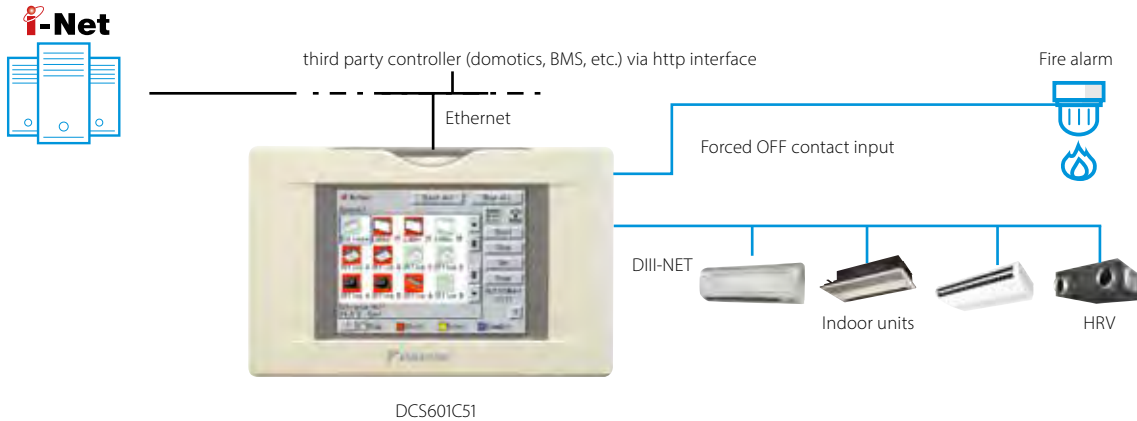

### Languages

- › English
- › French
- › German
- › Italian
- › Spanish
- › Dutch
- › Portuguese

### System layout

- › Up to 64 indoor units can be controlled
- › Touch panel (full colour LCD via icon display)

### Control

- › Individual control (set point, start/stop, fan speed) (max. 64 groups/indoor units)
- › Set back schedule
- › Enhanced scheduling function (8 schedules, 17 patterns)
- › Flexible grouping in zones
- › Yearly schedule
- › Fire emergency stop control
- › Interlocking control
- › Increased HRV monitoring and control function
- › Automatic cooling / heating change-over
- › Heating optimization
- › Temperature limit
- › Password security: 3 levels (general, administration & service)
- › Quick selection and full control
- › Simple navigation

### Monitoring

- › Visualisation via Graphical User Interface (GUI)
- › Icon colour display change function
- › Indoor units operation mode
- › Indication filter replacement

### Cost performance

- › Free cooling function
- › Labour saving
- › Easy installation
- › Compact design: limited installation space
- › Overall energy saving

### Open interface

- › Communication to any third party controller (domotics, BMS, etc.) is possible via open interface (http option DCS007A51)

### Connectable to

- › VRV
- › HRV
- › Sky Air
- › Split (via interface adapter)

# Advanced centralised controller with Cloud connection

- Intuitive and user-friendly interface
- Flexible concept for stand alone and multi site applications
- Total solution thanks to integration of 3rd party equipment
- Monitor & control your small commercial building, no matter where you are

**2 solutions:**

**Local solution**

- › Offline centralised control
- › Stylish optional screen fits any interior

**Cloud solution**

- › Flexible online control from any device (Laptop, tablet...)
- › Monitor & control one or multiple sites
- › Benchmark the energy consumption of different installations (1)
- › Energy consumption follow-up to comply with local regulations

**System layout**

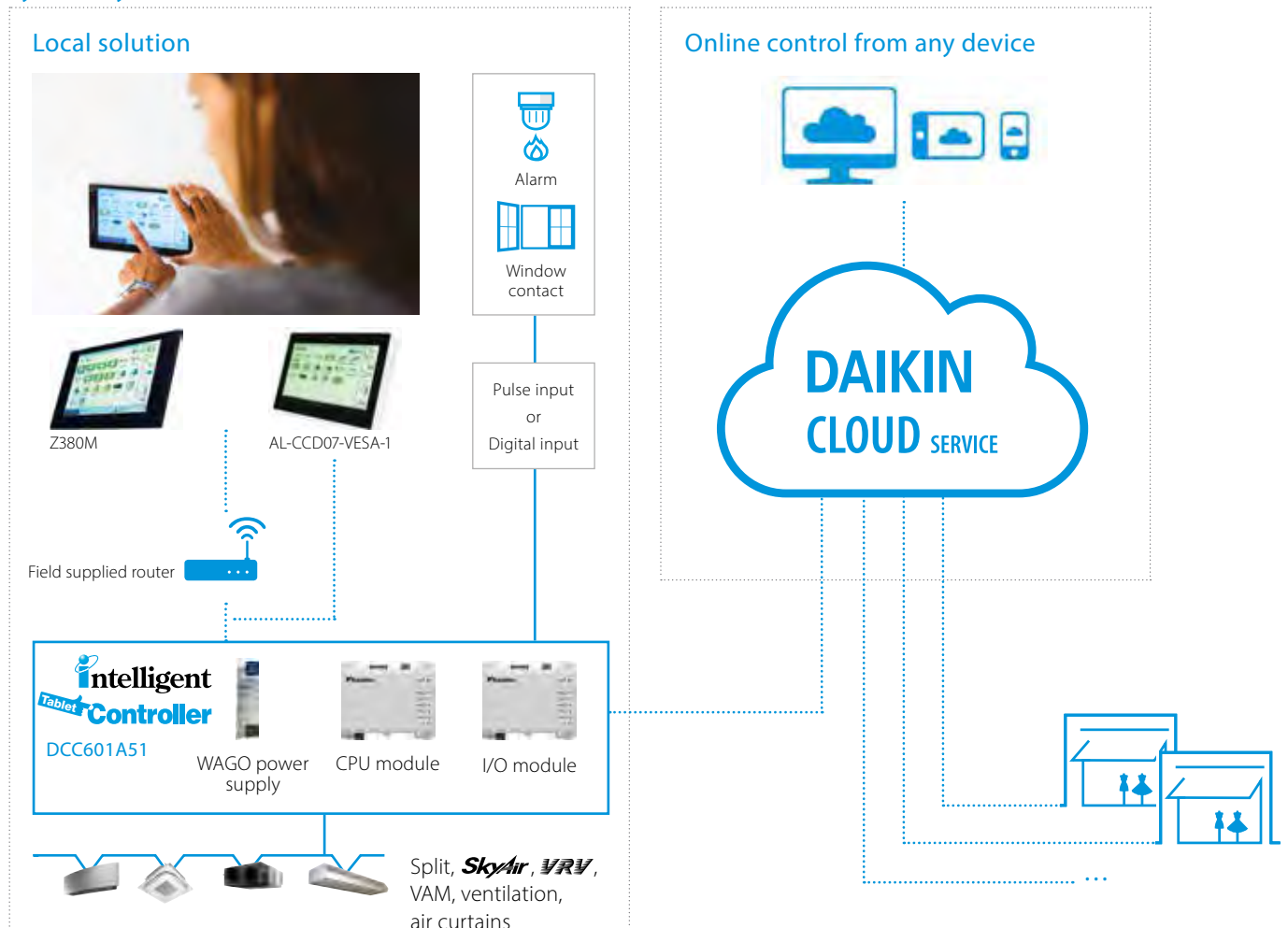

(1) For VRV and Sky Air R-32 ranges

**Total solution**

- › Total solution thanks to a large integration of Daikin products and 3rd party equipment
- › Connect a wide range of units (Split, Sky Air, VRV, Ventilation, Biddle air curtains)
- › Simply control your entire building centrally
- › Increased customer shopping experience by better management of your shop comfort level

**Daikin Cloud Services**

- › Control your building no matter where you are
- › Monitor and control multiple sites
- › Installer or technical manager can remotely login to the cloud for first troubleshooting
- › Benchmark the energy consumption of different installations (1)
- › Manage & track your energy use

**User friendly touch control**

- › Stylish Daikin supplied optional screen for local control fits any interior
- › Intuitive and user-friendly interface
- › Full solution with simple control
- › Easy commissioning

**Flexible**

- › Inputs via digital and pulse input for 3rd party equipment such as kWh meters, emergency input, window contact, ...
- › Modular concept allows your cloud to grow with your business
- › Control up to 32 indoor units per controller and 320 units per site

(1) only available in combination with certain indoor units

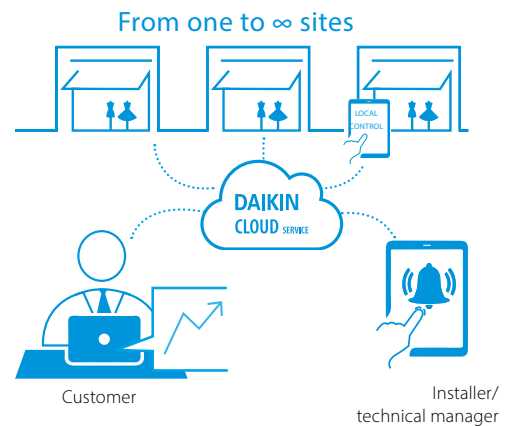

Intuitive control from the cloud



Easy follow up of energy consumption

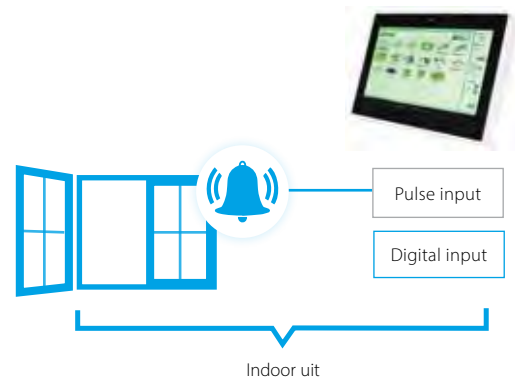

**Functions overview**

		Local solution	Cloud solution
<b>Languages</b>		Depends on local device	EN, DE, FR, NL, ES, IT, EL, PT, RU, TR, DA, SV, NO, FI, CS, HR, HU, PL, RO, SL, BG, SK
<b>System layout</b>	N° of connectable indoor units	32	32
	Multiple sites control		•
<b>Monitoring &amp; control</b>	Basic control functions (ON/OFF, mode, filter sign, setpoint, fan speed, ventilation mode, room temperature, ...)	•	•
	Remote control prohibition	•	•
	All devices ON/OFF	•	•
	Zone control		•
	Group control	•	•
	Weekly schedule	•	•
	Yearly schedule		•
	Interlock control	•	•
	Set point limitation		•
	Visualisation of energy use per operation mode		•
<b>Connectable to</b>	DX split, Sky Air, VRV	•	•
	VAM, VKM ventilation	•	•
	Air curtains	•	•

For available Daikin Cloud Service options refer to the option list

# Mini BMS

with full integration  
across all product pillars

DCM601A51



- Price competitive mini BMS
- Cross-pillar integration of Daikin products
- Integration of third party equipment



## NEW

Download the WAGO  
selection tool from  
[my.daikin.eu](http://my.daikin.eu)

- › Easy selection of WAGO materials
- › Material list creation
- › Time saving
  - Includes wiring schemes
  - Contains commissioning/preset data for iTM



Check on  
**You Tube**

[https://www.youtube.com/  
DaikinEurope](https://www.youtube.com/DaikinEurope)

# System overview

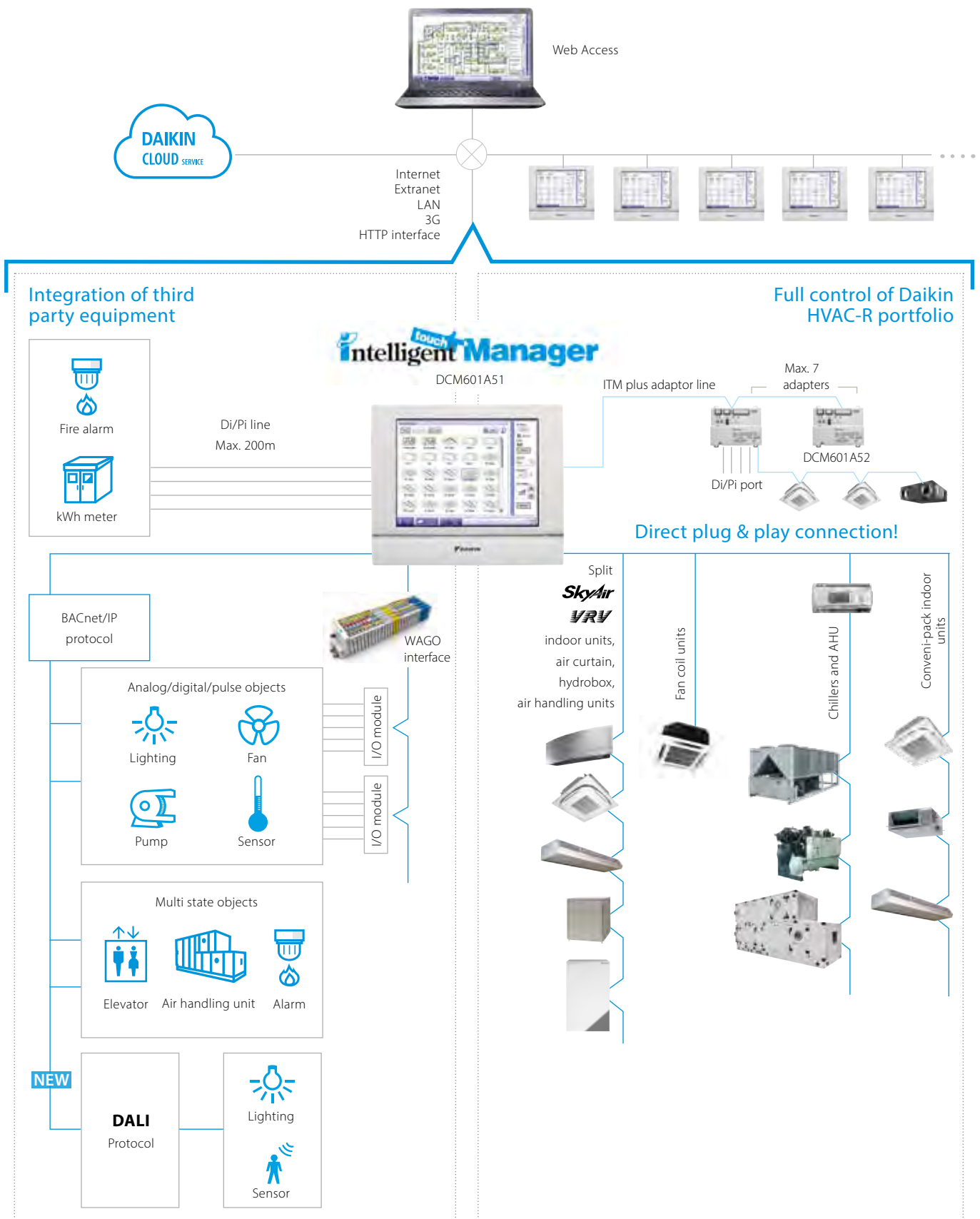

## Centralised control systems



### User friendliness

- › Intuitive user interface
- › Visual lay out view and direct access to indoor unit main functions
- › All functions direct accessible via touch screen or via web interface



### Smart energy management

- › Monitoring if energy use is according to plan
- › Helps to detect origins of energy waste
- › Powerful schedules guarantee correct operation throughout the year
- › Save energy by interlocking A/C operation with other equipment such as heating

### Flexibility

- › Cross-pillar integration (heating, air conditioning, applied systems, refrigeration, air handling units)
- › BACnet protocol for 3rd party products integration
- › I/O for integration of equipment such as lights, pumps... on WAGO modules
- › Modular concept for small to large applications
- › Control up to 512 indoor unit groups via one ITM and combine multiple ITM via web interface

### Easy servicing and commissioning

- › Remote refrigerant containment check reducing on site visit
- › Simplified troubleshooting
- › Save time on commissioning thanks to the pre-commissioning tool
- › Auto registration of indoor units

### Plug & play

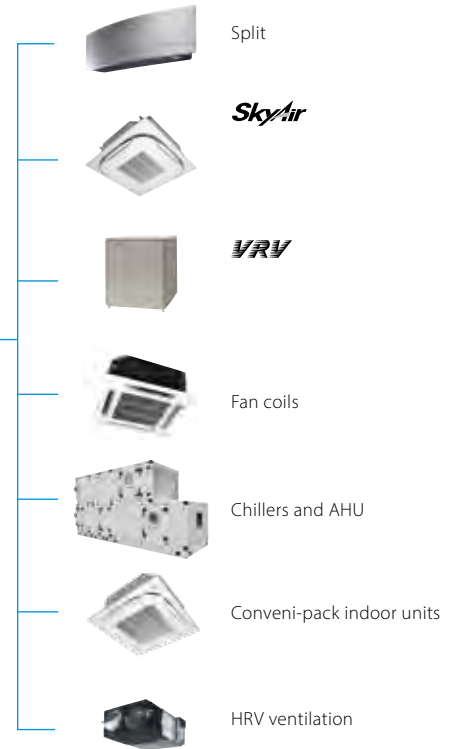

Flexibility in size  
64 up to 512 groups

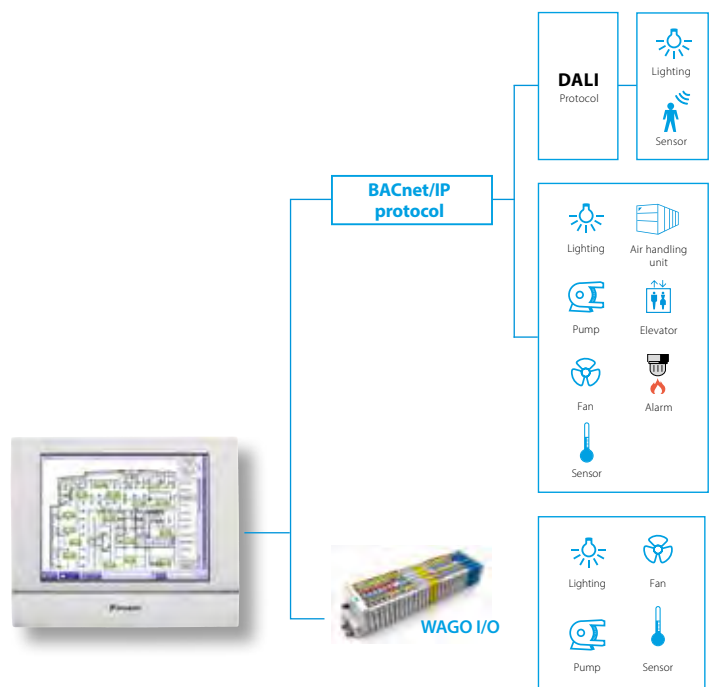



## Functions overview

### Languages

- › English
- › French
- › German
- › Italian
- › Spanish
- › Dutch
- › Portuguese

### Management

- › Web access
- › Power Proportional Distribution (option)
- › Operational history (malfunctions, ...)
- › Smart energy management
  - monitor if energy use is according to plan
  - detect origins of energy waste
- › Setback function
- › Sliding temperature

### WAGO Interface

- › Modular integration of 3rd party equipment
  - WAGO coupler (interface between WAGO and iTM)
  - Di module
  - Do module
  - Ai module
  - Ao module
  - Thermistor module
  - Pi module

### Open http interface

- › Communication to any third party controller (domotics, BMS, etc.) is possible via http open interface (http option DCM007A51)

### System layout

- › Up to 512 unit groups can be controlled (ITM + 7 iTM Plus adapters)

### Control

- › Individual control (512 groups)
- › Schedule setting (Weekly schedule, yearly calendar, seasonal schedule)
- › Interlock control
- › Setpoint limitation
- › Temperature limit

### DALI integration

- › Control and monitor the lights
- › Easier facility management: receive error signal when light or light controller has a malfunction
- › Flexible approach and less wiring needed, compared to classic light scheme
- › Easier to make groups and control scenes
- › Connection between intelligent Touch Manager and DALI through WAGO BACnet IP interface

### Connectable to

- DX Split, Sky Air, VRV
- HRV
- Chillers (via MT3-EKMBACIP controller)
- Daikin AHU (via MT3-EKMBACIP controller)
- Fan coils
- Daikin Altherma Flex type
- LT and HT hydroboxes
- Biddle Air curtains
- WAGO I/O
- BACnet/IP protocol
- Daikin PMS interface (option DCM010A51)

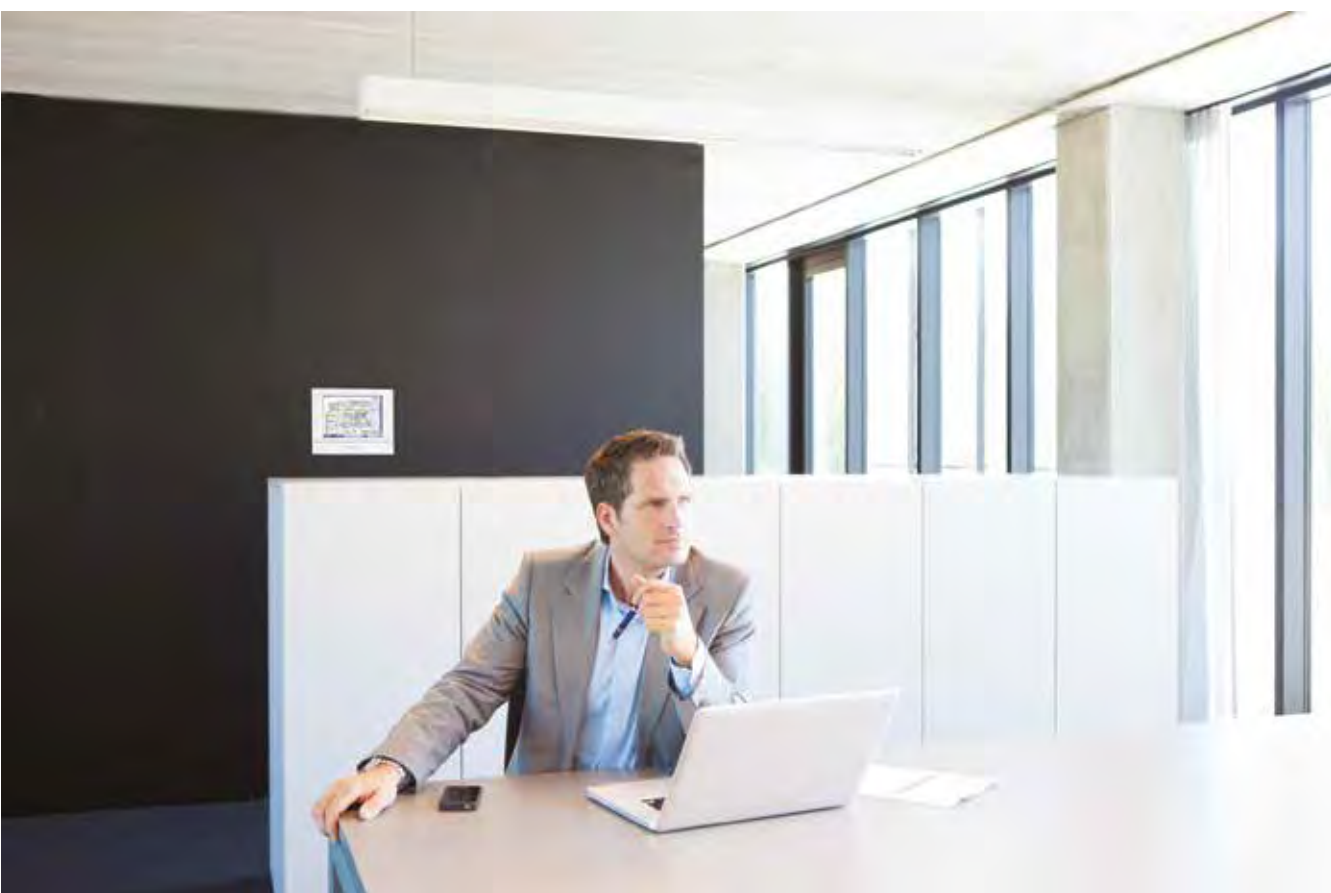

# Modbus Interface

## RTD

### RTD-RA

- › Modbus interface for monitoring and control of residential indoor units

### RTD-NET

- › Modbus interface for monitoring and control of Sky Air, VRV, VAM and VKM

### RTD-10

- › Advanced integration into BMS of Sky Air, VRV, VAM and VKM through either:
  - Modbus
  - Voltage (0-10V)
  - Resistance
- › Duty/standby function for server rooms

### RTD-20

- › Advanced control of Sky Air, VRV, VAM/VKM and air curtains
- › Clone or independent zone control
- › Increased comfort with integration of CO<sub>2</sub> sensor for fresh air volume control
- › Save on running costs via
  - pre/post and trade mode
  - set point limitation
  - overall shut down
  - PIR sensor for adaptive deadband

### RTD-HO

- › Modbus interface for monitoring and control of Sky Air, VRV, VAM and VKM
- › Intelligent hotel room controller

### RTD-W

- › Modbus interface for monitoring and control of Daikin Altherma Flex Type, VRV HT hydrobox and small inverter chiller



## Overview functions



Main functions			RTD-RA	RTD-NET	RTD-10	RTD-20	RTD-HO
Dimensions	H x W x D	mm	80 x 80 x 37,5			100 x 100 x 22	
Key card + window contact							
Set back function			R				
Prohibit or restrict remote control functions (setpoint limitation, ...)			R	R			
Modbus (RS485)							
Group control			R (1)	R			
0 - 10 V control							
Resistance control							
IT application			R				
Heating interlock							
Output signal (on/defrost, error)					R	R	
Retail application							
Partitioned room control							
Air curtain				R***	R***	R	

(1): By combining RTD-RA devices

Control functions	RTD-RA	RTD-NET	RTD-10	RTD-20	RTD-HO
On/Off	M,C	M	M,V,R	M	M*
Set point	M	M	M,V,R	M	M*
Mode	M	M	M,V,R	M	M*
Fan	M	M	M,V,R	M	M*
Louver	M	M	M,V,R	M	M*
HRV Damper control	M	M	M,V,R	M	M*
Prohibit/Restrict functions	M	M	M,V,R	M	M*
Forced thermo off	M				

Monitoring functions	RTD-RA	RTD-NET	RTD-10	RTD-20	RTD-HO
On/Off	M	M	M	M	M
Set point	M	M	M	M	M
Mode	M	M	M	M	M
Fan	M	M	M	M	M
Louver	M	M	M	M	M
RC temperature		M	M	M	M
RC mode		M	M	M	M
N° of units		M	M	M	M
Fault	M	M	M	M	M
Fault code	M	M	M	M	M
Return air temperature (Average /Min/Max)	M	M	M	M	M
Filter alarm		M	M	M	M
Thermo on	M	M	M	M	M
Defrost		M	M	M	M
Coil In/Out temperature	M	M	M	M	M



Main functions			RTD-W
Dimensions	H x W x D	mm	100x100x22
On/off prohibition			R
Modbus RS485			R
Dry contact control			R
Output signal (operation error)			R
Space heating / cooling operation			R
Domestic hot water control			R
Smart Grid control			

Control functions	RTD-W
On/Off Space heating/cooling	M,C
Set point leaving water temperature (heating / cooling)	M,V
Room temperature setpoint	M
Operation mode	M
Domestic Hot water ON	
Domestic Hot Water reheat	M,C
Domestic Hot Water reheat setpoint	
Domestic Hot Water storage	M
Domestic Hot Water Booster setpoint	
Quiet mode	M,C
Weather dependent setpoint enable	M
Weather dependent curve shift	M
Fault/pump info relay choice	
Control source prohibition	M

Smart grid mode control	RTD-W
Prohibit Space heating/cooling	
Prohibit DHW	
Prohibit Electric heaters	
Prohibit All operation	
PV available for storage	
Powerful boost	

Monitoring functions	RTD-W
On/Off Space heating/cooling	M,C
Set point leaving water temperature (H/C)	M
Room temperature setpoint	M
Operation mode	M
Domestic Hot Water reheat	M
Domestic Hot Water storage	M
Number of units in the group	M
Average leaving water temperature	M
Remocon room temperature	M
Fault	M,C
Fault code	M
Circulation pump operation	M
Flow rate	
Solar pump operation	
Compressor status	M
Desinfection operation	M
Setback operation	M
Defrost/ start up	M
Hot start	
Booster Heater operation	
3-Way valve status	
Pump running hours accumulated	M
Compressor running hours accumulated	
Actual leaving water temperature	M
Actual return water temperature	M
Actual DHW tank temperature (*)	M
Actual refrigerant temperature	
Actual outdoor temperature	M

M : Modbus / R : Resistance / V : Voltage / C: control  
 \* : only when room is occupied / \*\* : setpoint limitation / (\*) if available  
 \*\*\* : no fan speed control on the CVV air curtain / \*\*\*\* : run & fault

# DIII-net Modbus interface

EKMBDXA

Integrated control system for seamless connection between Split, Sky Air, VRV and small inverter chillers and BMS systems

- > Communication via Modbus RS485 protocol
- > Detailed monitoring and control of the VRV total solution
- > Easy and fast installation via DIII-net protocol
- > As the Daikin DIII-net protocol is being used, only one modbus interface is needed for a group of Daikin systems (up to 10 outdoor units systems).

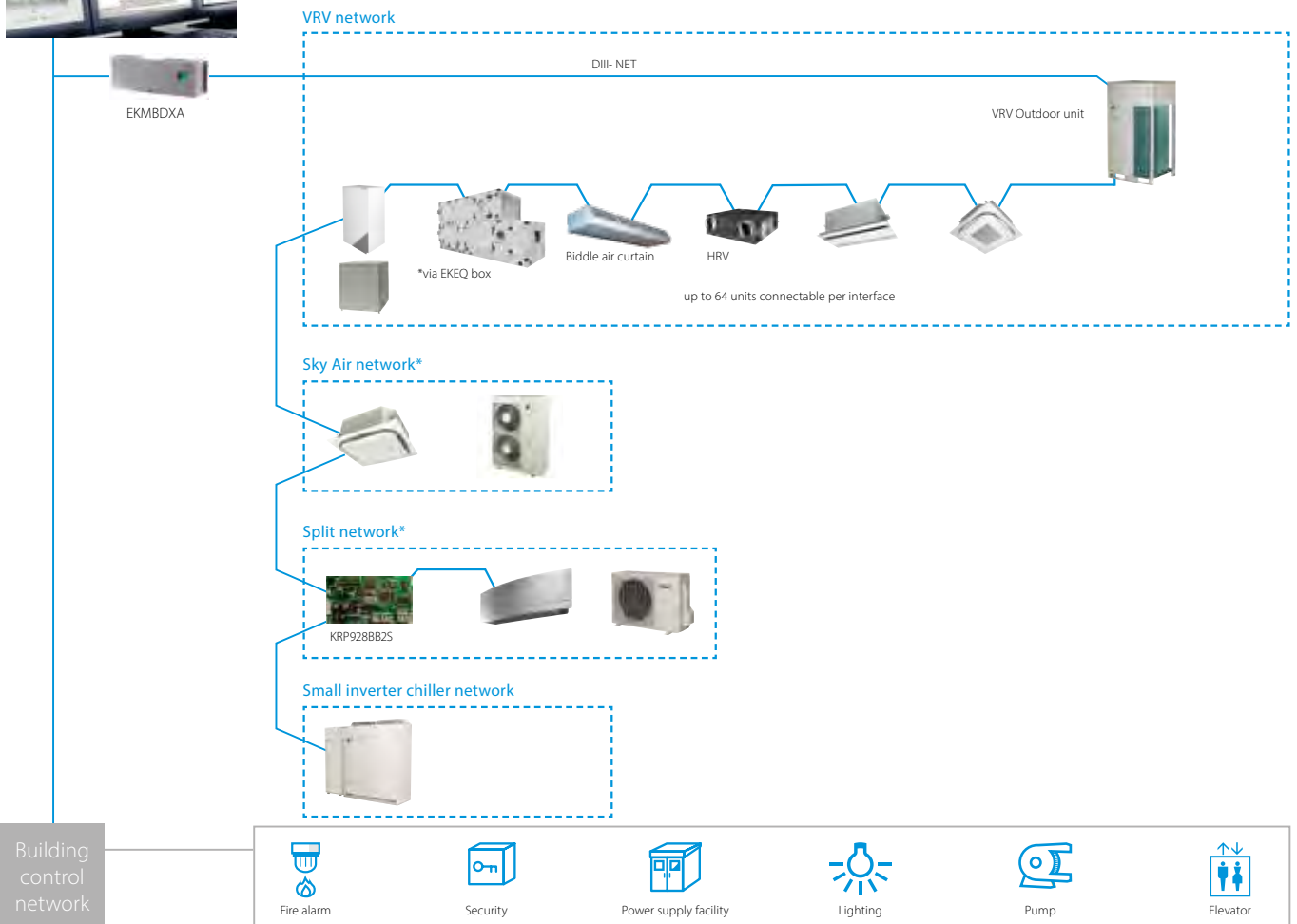

\* Additional centralized controller might be required. For more information contact your local dealer.

		<b>EKMBDXA7V1</b>	
Maximum number of connectable indoor units		64	
Maximum number of connectable outdoor units		10	
Communication	DIII-NET - Remark	DIII-NET (F1F2)	
	Protocol - Remark	2 wire; communication speed: 9600 bps or 19200 bps	
	Protocol - Type	RS485 (modbus)	
	Protocol - Max. Wiring length	m	500
Dimensions	HeightxWidthxDepth	mm	124x379x87
Weight		kg	2.1
Ambient temperature - operation	Max.	°C	60
	Min.	°C	0
Installation			Indoor installation
Power supply	Frequency	Hz	50
	Voltage	V	220-240

# KNX interface

KLIC-DD  
KLIC-DI

## Integration of Split, Sky Air and VRV in HA/BMS systems

Connect split indoor units to KNX interface for Home Automation system



Connect Sky Air / VRV indoor units to KNX interface for BMS integration

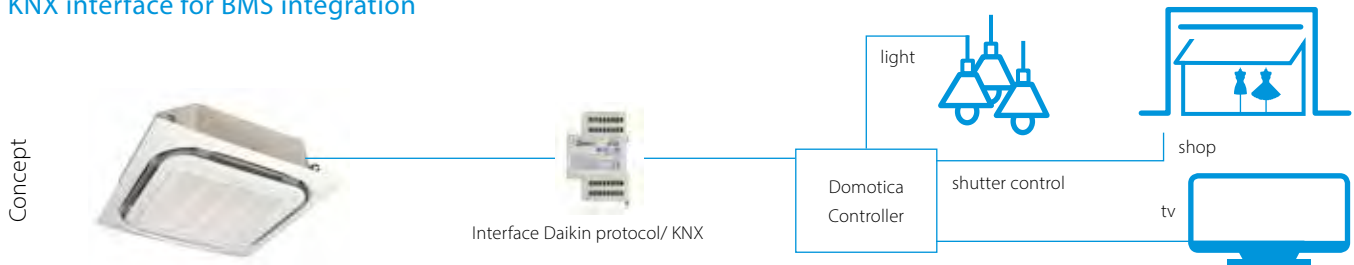



### KNX interface line-up

The integration of Daikin indoor units through the KNX interface allows monitoring and control of several devices, such as lights and shutters, from one central controller. One particularly important feature is the ability to programme a 'scene' - such as "Home leave" - in which the end-user selects

a range of commands to be executed simultaneously once the scenario is selected. For instance in "Home leave", the air conditioner is off, the lights are turned off, the shutters are closed and the alarm is on.

### KNX interface for

	 <b>KLIC-DD Size 45x45x15mm</b>	 <b>KLIC-DI Size 90x60x35mm</b>	
	<b>Split</b>	<b>Sky Air</b>	<b>VRV</b>
<b>Basic control</b>			
On/Off	●	●	●
Mode	Auto, heat, dry, fan, cool	Auto, heat, dry, fan, cool	Auto, heat, dry, fan, cool
Temperature	●	●	●
Fan speed levels	3 or 5 + auto	2 or 3	2 or 3
Swing	Stop or movement	Stop or movement	Swing or fixed positions (5)
<b>Advanced functionalities</b>			
Error management	Communication errors, Daikin unit errors		
Scenes	●	●	●
Auto switch off	●	●	●
Temperature limitation	●	●	●
Initial configuration	●	●	●
Master and slave configuration		●	●

# PMS Interface

DCM010A51

## Hotel interface connecting Daikin HVAC with Oracle Property Management Systems



Room view showing room status: check-in, check-out, pre-heating / cooling status, room temperature and A/C status

HVAC settings can be easily observed and changed by the reception desk

Multiple room types (bedroom, meeting room, ...) can be defined with customized A/C settings for each type

### Features

- > User-friendly interface for easy front desk support in hotels, conference centers, ...
- > Compatible with Oracle Opera PMS (formerly known as Micros Fidelio)
- > Automated push of indoor unit settings based on the Opera PMS Check-In and Check-Out commands
- > Energy saving thanks to the possibility to limit temperature setpoint
- > Up to 5 customized operation profiles based on weather conditions
- > Available in 23 languages
- > Up to 2,500 units / rooms can be managed

#### Hotel case example:

- > On check-in the HVAC for the room is automatically switched on
- > On check-out the HVAC for the room is automatically switched off.
- > Increased hotel customer experience by pre-heating / cooling of booked rooms

#### Hotel front desk

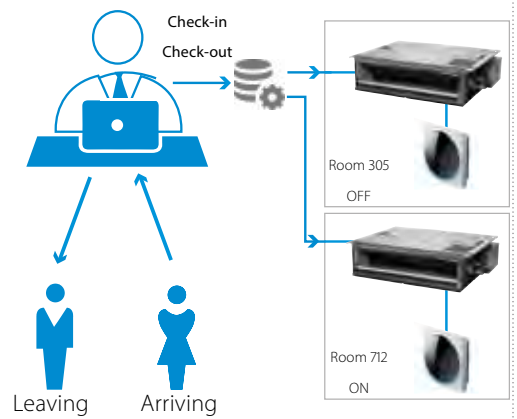

Check-Out room 305    Check-In room 712

### Simplified configuration of Daikin PMS interface

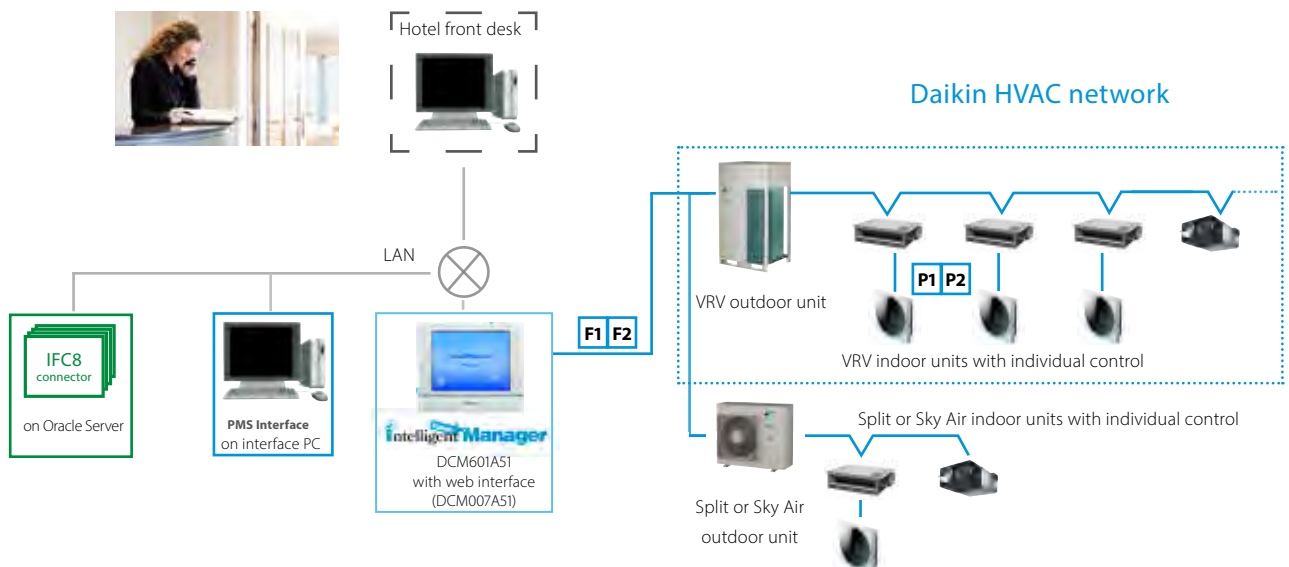

# BACnet Interface

DMS502A51 / EKACBACMSTP / EKCMBACIP / EKCMBACMSTP

Integrated control system for seamless connection between VRV, applied systems, air handling units and BMS systems

- › Interface for BMS system
- › Communication via BACnet protocol (connection via Ethernet)
- › Unlimited site size
- › Easy and fast installation
- › PPD data is available on BMS system (only for VRV)

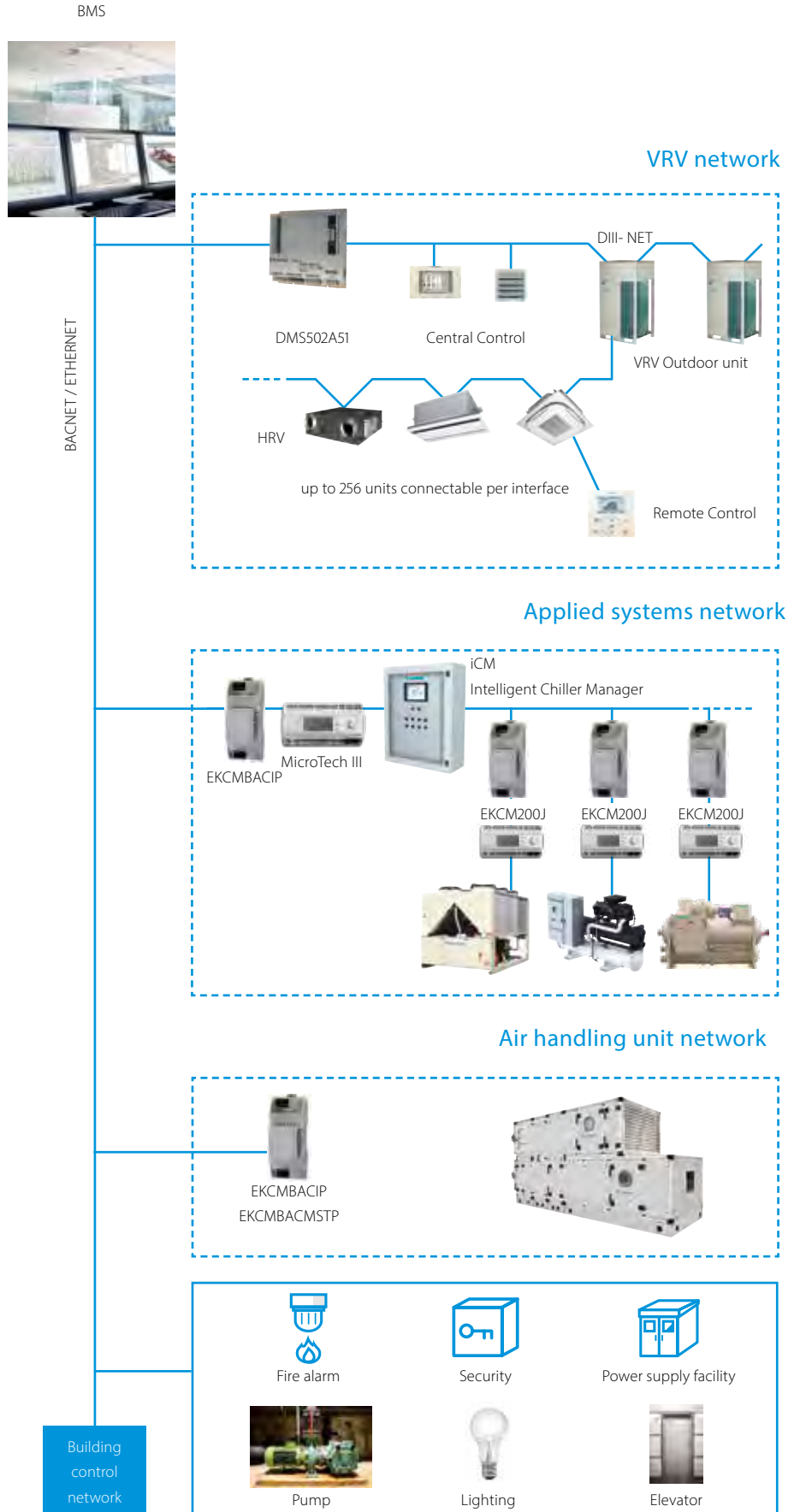

# LonWorks Interface

DMS504B51

Open network integration of VRV monitoring and control functions into LonWorks networks

- > Interface for Lon connection to LonWorks networks
- > Communication via Lon protocol (twisted pair wire)
- > Unlimited sitesize
- > Quick and easy installation

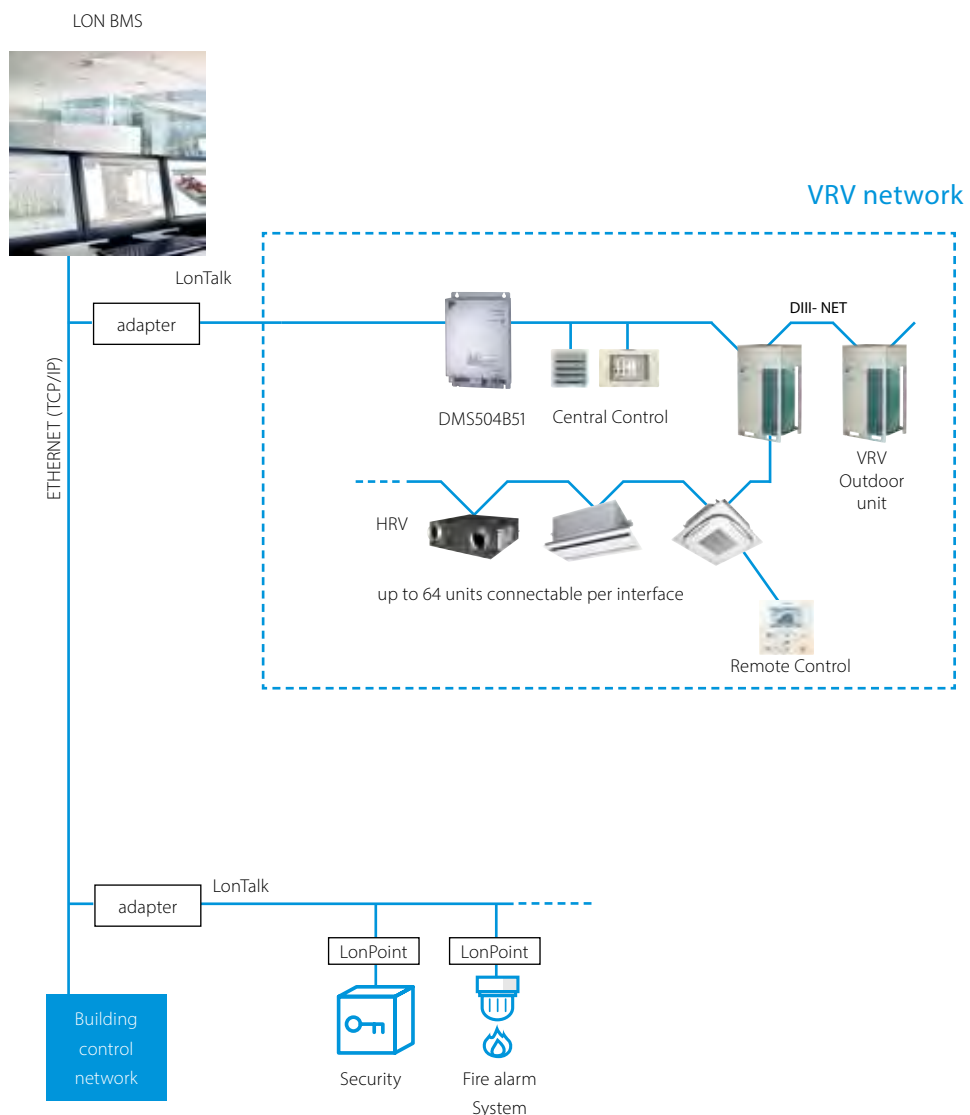



# Daikin Configurator Software

EKPCCAB3

Simplified commissioning:  
graphical interface to configure, commission  
and upload system settings

## Simplified commissioning

The Daikin configurator for Daikin Altherma and VRV is an advanced software solution that allows for easy system configuration and commissioning:

- › Less time is required on the roof configuring the outdoor unit
- › Multiple systems at different sites can be managed in exactly the same way, thus offering simplified commissioning for key accounts
- › Initial settings on the outdoor unit can be easily retrieved



Simplified  
commissioning



Retrieve initial  
system settings



# Daikin Cloud Service



to achieve optimal operation

Daikin Cloud Service is a cloud-based remote control and monitoring solution for DX systems. Using enhanced control, monitoring and predictive logic, Daikin Cloud Service provides real-time data and support from Daikin experts to help you identify cost-saving opportunities, increase the lifetime of your equipment and reduce the risk of unexpected issues.

Monitor & control\* your system no matter where you are while teaming up with Daikin experts

## Remote control and energy visualisation

### Puts you in the driving seat of your energy management

- Control and monitor your premises, wherever you are
- Centralised control and monitoring of all your premises
- Check errors remotely without having to go on site
- Visualise energy consumption and reduce energy waste by comparing different premises

### Multi-site monitoring

From one to an ∞ number of sites

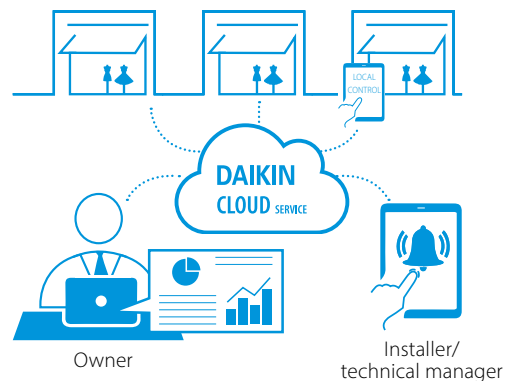

## Remote support and diagnostics

### Daikin specialist supervision, so you can focus on your core business

- Early warning of system deviations to maximise system uptime and avoid emergency repairs\*\*
- Service providers have access to operational data so they arrive on site prepared
- Remote expert assistance in case of errors



## Advice and optimisation

### Get the best out of your system through expert advice

- Periodical analysis and optimisation report by experts
- Personalised actions to maximise energy efficiency and comfort
- Increased system lifetime as the system runs as it should

**Daikin Cloud Service requires a subscription. Contact your local sales representative for more information.**

\* Remote Control function via Daikin Cloud Service only available for sites with an Intelligent Tablet controller

\*\* Only available for VRV systems

# Daikin Cloud Service packages

	Control and monitoring	Remote support and diagnostics	Advice and optimisation
Remote control, scheduling and interlocking	✓ (DCC601A51 only)	✓ (DCC601A51 only)	✓ (DCC601A51 only)
Energy monitoring	✓	✓	✓
Multi-site benchmark	✓	✓	✓
Alarm history and e-mail notifications**	✓	✓	✓
Predictions and e-mail notifications**	✗	✓	✓
Operational data access	✗	✓	✓
Indoor use analysis	✗	✓	✓
Outdoor use analysis	✗	✓	✓
Remote diagnostic and support from Daikin	✗	✓	✓
Periodical analysis and optimisation advice from Daikin	✗	✗	✓
Can be combined with maintenance programmes: - Technical inspection - Preventive Maintenance Plan - Comprehensive Maintenance Plan	✗	✗	✓

Packages subject to local availability  
Daikin Cloud Service replaces VRV Cloud and i-Net services.

## Flexible solution

Manage your premises according to your needs, using a local control or remotely via Daikin Cloud Service, or a combination of both.

## Control\*, no matter where you are

Daikin Cloud Service gives you full control of one or more premises wherever you are, using your PC, tablet or smartphone.

## Predictive logic for VRV to prevent breakdowns

The operational data is continuously analysed by Daikin algorithms to predict potential failures and avoid unexpected costs.

## Compatible with:

- > Intelligent Tablet Controller (DCC601A51)
- > Intelligent Touch Manager (DCM601A51) + IoT gateway
- > LC8 + IoT gateway



1. Monitor and control your system



2. Compare energy use with target



3. Compare energy use from multiple sites



4. Detailed energy consumption follow up



5. Follow up of alarm and fault prediction

\* Remote Control function via Daikin Cloud Service only available for sites with an Intelligent Tablet controller

\*\* Only available for VRV systems

# Wireless room temperature sensor

K.RSS



## Flexible and easy installation

- > Accurate temperature measurement thanks to flexible placement of the sensor
- > No need for wiring
- > No need to drill holes
- > Ideal for refurbishment

## Connection diagram Daikin indoor unit PCB (FXSQ example)

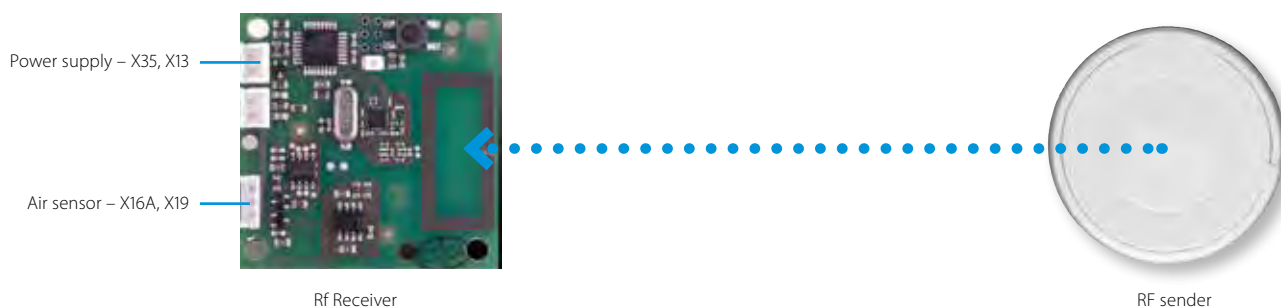

## Specifications

			Wireless room temperature sensor kit (K.RSS)	
			Wireless room temperature receiver	Wireless room temperature sensor
Dimensions	mm		50 x 50	ø 75
Weight	g		40	60
Power supply			16VDC, max. 20 mA	N/A
Battery life			N/A	+/- 3 years
Battery type			N/A	3 Volt Lithium battery
Maximum range	m			10
Operation range	°C			0~50
Communication	Type			RF
	Frequency	MHz		868.3

- > Room temperature is sent to the indoor unit every 90 seconds or if the temperature difference is 0.2°C or larger.

# Wired room temperature sensor

KRCS01-1B  
KRCS01-4B



- > Accurate temperature measurement, thanks to flexible placement of the sensor











## Specifications

Dimensions (HxW)	mm	60 x 50
Weight	g	300
Length of branch wiring	m	12

## ADAPTER PCBs



### Simple solutions for unique requirements Concept and benefits

- › Low cost option to satisfy simple control requirements
- › Deployed on single or multiple units

			Connectable to:		
			Split	Sky Air	VRV
	<b>(E)KRP1B*</b> adapter for wiring	<ul style="list-style-type: none"> <li>Facilitates integration of auxiliary heating apparatus, humidifiers, fans, damper</li> <li>Powered by and installed at the indoor unit</li> </ul>		●	●
	<b>KRP2A*/KRP4A*</b> Wiring adapter for electrical appendices	<ul style="list-style-type: none"> <li>Remotely start and stop up to 16 indoor units (1 group) (KRP2A* via P1 P2)</li> <li>Remotely start and stop up to 128 indoor units (64 groups) (KRP4A* via F1 F2)</li> <li>Alarm indication/ fire shut down</li> <li>Remote temperature setpoint adjustment</li> <li>Cannot be used in combination with a central controller</li> </ul>		●	●
	<b>KRP58M3</b>	<ul style="list-style-type: none"> <li>Low noise and demand control option for RZQ200/250C</li> </ul>		●	
	<b>SB.KRP58M51</b>	<ul style="list-style-type: none"> <li>Low noise and demand control option for RZQG and RZQSG single phase</li> <li>Includes mounting plate EKMKA1</li> </ul>		●	
	<b>KRP58M51</b>	<ul style="list-style-type: none"> <li>Low noise and demand control option for RZQG1 and RZQSG 3 phase</li> </ul>		●	
	<b>DTA104A*</b> Outdoor Unit External Control Adapter	<ul style="list-style-type: none"> <li>Individual or simultaneous control of VRV system operating mode</li> <li>Demand control of individual or multiple systems</li> <li>Low noise option for individual or multiple systems</li> </ul>			●
	<b>DCS302A52</b> Unification adapter for computerized control	<ul style="list-style-type: none"> <li>Enables unified display (operation/malfunction) and unified control (ON/OFF) from BMS system</li> <li>Must be used together with intelligent Touch Controller or intelligent Touch Manager</li> <li>Cannot be combined with KRP2/4*</li> <li>Can be used for all VRV indoor models</li> </ul>			●
	<b>KRP928*</b> Interface adapter for DIII-net	<ul style="list-style-type: none"> <li>Allows integration of split units to Daikin central controls</li> </ul>	●		
	<b>KRP413*</b> Wiring adapter normal open contact / normal open pulse contact	<ul style="list-style-type: none"> <li>Switch off auto restart after power failure</li> <li>Indication of operation mode / error</li> <li>Remotely start /stop</li> <li>Remotely change operation mode</li> <li>Remotely change fan speed</li> </ul>	●		
	<b>KRP980*</b> Adapter for split units without an S21 port	<ul style="list-style-type: none"> <li>Connect a wired remote control</li> <li>Connect to Daikin central controls</li> <li>Allow external contact</li> </ul>	●		

Some adapters require an installation box, refer to the option lists for more information

## Accessories

<b>EKRORO</b>		<ul style="list-style-type: none"> <li>External ON/OFF or forced off</li> <li>Example: door or window contact</li> </ul>
<b>EKRORO 3</b>		<ul style="list-style-type: none"> <li>External ON/OFF or forced off</li> <li>F1/F2 contact</li> <li>Example: door or window contact</li> </ul>
<b>KRC19-26A</b>		<ul style="list-style-type: none"> <li>Mechanical cool/heat selector</li> <li>Allows switching over an entire system between cooling/heating/fan only</li> <li>Connects to the A/B/C terminals of the unit</li> </ul>
<b>BRP2A81</b>		<ul style="list-style-type: none"> <li>Cool/heat selector PCB</li> <li>Required to connect KRC19-26A to a VRV IV outdoor unit</li> </ul>

AUTO-CLEANING PANEL



FILTERS



INTELLIGENT SENSORS

# Options & accessories

VRV outdoor	192
VRV indoor	196
Stylish indoor	200
Ventilation & Hot Water	202
Control Systems	203

Options & accessories - **VRV** outdoor

		VRV IV Heat Recovery				
		REYQ 8~12	REYQ 14~20	REMQ5	2-module systems	3-module systems
	<b>Multi-module connection kit (obligatory)</b> - Connects multiple modules into a single refrigerant system				BHFQ23P907	BHFQ23P1357
	<b>Extended level difference kit</b> - Allows outdoor unit to be more than 50m above indoor units	Special order unit				
Kits	<b>Central drain pan kit</b> - Installs onto the underside of the outdoor unit and collects drain water from all bottom plate outlets into a single outlet. In cold areas should be heated by a field-supplied heater to prevent drain water from freezing in the drain pan.					
	<b>Heater tape kit</b> - Optional electrical heater to guarantee trouble-free operation in extremely cold and humid climates (one per outdoor unit needed)	EKBPH012T7A	EKBPH020T7A	EKBPH012T7A		
	<b>BHGP26A1</b> Digital pressure gauge kit – displays current condensing and evaporating pressures in the system as Standard, or expansion valve positions and temperature sensor data in a special service mode. Connect to the outdoor unit PCB, for installation in the outdoor unit.	•	•	•	1 kit per system	1 kit per system
	<b>External control adapter for outdoor unit</b> - Allows to activate Low Noise Operation and three levels of demand control, limiting power consumption via external dry contacts. Connects to the F1/F2 communication line and requires power supply from an indoor unit*, BSVQ box, or VRV-WIII outdoor unit.	DTA104A53/61/62 For installation into an indoor unit: exact adapter type depends on type of indoor unit. For 14-20 HP the demand PCB mounting plate is required. See Options & Accessories of indoor units				
Adapters	<b>KRC19-26A</b> Mechanical cool/heat selector – allows to switch an entire Heat Pump system, or one BS-box of a Heat Recovery system between cooling, heating and fan only. Connects to the A-B-C terminals of the outdoor unit / BS-box.					
	<b>EBRP2B</b> - Cool/heat selector PCB					
	<b>BRP2A81</b> Cool/heat selector PCB (required to connect KRC19-26A to VRV IV outdoor)					
	<b>KKSA26A560*</b> Cool/heat selector PCB mounting plate (only required when cool/heat selector PCB and Heater tape kit are combined)					
Others	<b>KJB111A</b> Installation box for remote cool/heat selector KRC19-26A					
	<b>EKCHSC</b> - Cool/heat selector cable					
	<b>EKPCCAB4</b> VRV configurator	•	•	•	•	•
	<b>KKSB26B1*</b> Demand PCB mounting plate. Needed to mount Demand PCB for one or more outdoor units.					
	<b>DTA109A51</b> DIII-net expander adapter	•	•	•	•	•
	<b>BPMKS967A2/A3</b> Branch provider (for connection of 2/3 RA indoor units)					
	<b>EKDK04</b> Drain plug kit					

		VRV IV S-series		
		RXYSQ-T	RXYSQ4-6T8V	RXYSQ4-6T8Y
	<b>Multi-module connection kit (obligatory)</b> - Connects multiple modules into a single refrigerant system			
	<b>Extended level difference kit</b> - Allows outdoor unit to be more than 50m above indoor units			
Kits	<b>Central drain pan kit</b> - Installs onto the underside of the outdoor unit and collects drain water from all bottom plate outlets into a single outlet. In cold areas should be heated by a field-supplied heater to prevent drain water from freezing in the drain pan.			
	<b>Heater tape kit</b> - Optional electrical heater to guarantee trouble-free operation in extremely cold and humid climates (one per outdoor unit needed)			
	<b>BHGP26A1</b> Digital pressure gauge kit – displays current condensing and evaporating pressures in the system as Standard, or expansion valve positions and temperature sensor data in a special service mode. Connect to the outdoor unit PCB, for installation in the outdoor unit.			
	<b>External control adapter for outdoor unit</b> - Allows to activate Low Noise Operation and three levels of demand control, limiting power consumption via external dry contacts. Connects to the F1/F2 communication line and requires power supply from an indoor unit*, BSVQ box, or VRV-WIII outdoor unit.	DTA104A53/61/62 For installation into an indoor unit: exact adapter type depends on type of indoor unit. See Options & Accessories of indoor units		
Adapters	<b>KRC19-26A</b> Mechanical cool/heat selector – allows to switch an entire Heat Pump system, or one BS-box of a Heat Recovery system between cooling, heating and fan only. Connects to the A-B-C terminals of the outdoor unit / BS-box.		•	•
	<b>EBRP2B</b> - Cool/heat selector PCB (Required to connect KRC19-26A)		•	
	<b>BRP2A81</b> Cool/heat selector PCB (required to connect KRC19-26A to VRV IV outdoor)			
	<b>KKSA26A560*</b> Cool/heat selector PCB mounting plate (only required when cool/heat selector PCB and Heater tape kit are combined)			
Others	<b>KJB111A</b> Installation box for remote cool/heat selector KRC19-26A		•	•
	<b>EKCHSC</b> - Cool/heat selector cable (Required to connect KRC19-26A)			•
	<b>EKPCCAB4</b> VRV configurator	•	•	•
	<b>KKSB26B1*</b> Demand PCB mounting plate. Needed to mount Demand PCB for one or more outdoor units.			
	<b>DTA109A51</b> DIII-net expander adapter			
	<b>BPMKS967A2/A3</b> Branch provider (for connection of 2/3 RA indoor units)	•	•	•
	<b>EKDK04</b> Drain plug kit		•	•



VRV IV with continuous heating						VRV IV without continuous heating				VRV IV C+series			
RYYQ8-12	RYYQ14-20	RYMQ8-12	RYMQ14-20	2-module systems	3-module systems	RXYQ8-12	RXYQ14-20	2-module systems	3-module systems	RXYLQ	RXMLQ	2-module systems	3-module systems
				BHFQ22P1007	BHFQ22P1517			BHFQ22P1007	BHFQ22P1517			BHFQ22P1007	BHFQ22P1517
EKBPH012T7A	EKBPH020T7A	EKBPH012T7A	EKBPH020T7A			EKBPH012T7A	EKBPH020T7A						
•	•	•	•	1 kit per system	1 kit per system	•	•	1 kit per system	1 kit per system				

DTA104A53/61/62

For installation into an indoor unit: exact adapter type depends on type of indoor unit.  
For 14-20 HP the demand PCB mounting plate is required. See Options & Accessories of indoor units

•	•	•	•	1 kit per system	1 kit per system	•	•	1 kit per system	1 kit per system	•	•	1 kit per system	1 kit per system
•	•	•	•	1 kit per system	1 kit per system	•	•	1 kit per system	1 kit per system	•	•	1 kit per system	1 kit per system
	•		•	1 kit per system	1 kit per system		•	1 kit per system	1 kit per system				
•	•	•	•	1 kit per system	1 kit per system	•	•	1 kit per system	1 kit per system	•	•	1 kit per system	1 kit per system
•	•	•	•	•	•	•	•	•	•	•	•	•	•
	•		•				•						
•	•	•	•	•	•	•	•	•	•				
•	•					•	•			•	•		

RXYSQ8-12TY1	VRV IV i-series SB.RKXYQ			
	RDXYQ5	RDXYQ8	RKXYQ5	RKXYQ8
	EKDPH1RDX	EKDPH1RDX		

DTA104A53/61/62

For installation into an indoor unit: exact adapter type depends on type of indoor unit.  
See Options & Accessories of indoor units

			•	•
				•
				•
			•	•
•			•	•
•				

		VRV IV-Q Heat Pump Replacement VRV				
		RQYQ 140P	RXYQQ8-12	RXYQQ14-20	2-module systems	3-module systems
Kits	<b>Multi-module connection kit (obligatory)</b> Connects multiple modules into a single refrigerant system				BHFQ22P1007	BHFQ22P1517
	<b>Central drain pan kit</b> - Installs onto the underside of the outdoor unit and collects drain water from all bottom plate outlets into a single outlet. In cold areas should be heated by a field-supplied heater to prevent drain water from freezing in the drain pan.	KWC26B160				
	<b>Heater tape kit</b> - Optional electrical heater to guarantee trouble-free operation in extremely cold and humid climates (one per outdoor unit needed)		EKBPH012T7A	EKBPH020T7A		
	<b>BHGP26A1</b> Digital pressure gauge kit – displays current condensing and evaporating pressures in the system as Standard, or expansion valve positions and temperature sensor data in a special service mode. Connect to the outdoor unit PCB, for installation in the outdoor unit.	•	•	•	1 kit per system	1 kit per system
Adapters	<b>External control adapter for outdoor unit</b> - Allows to activate Low Noise Operation and three levels of demand control, limiting power consumption via external dry contacts. Connects to the F1/F2 communication line and requires power supply from an indoor unit*, BSVQ box, or VRV-WIII outdoor unit.		DTA104A53/61/62 For installation into an indoor unit: exact adapter type depends on type of indoor unit. For 14-20 HP the demand PCB mounting plate is required. See Options & Accessories of indoor units		DTA104A53/61/62 For installation into an indoor unit: exact adapter type depends on type of indoor unit. For 14-20 HP the demand PCB mounting plate is required. See Options & Accessories of indoor units	
	<b>KRC19-26A</b> Mechanical cool/heat selector – allows to switch an entire Heat Pump system, or one BS-box of a Heat Recovery system between cooling, heating and fan only. Connects to the A-B-C terminals of the outdoor unit / BS-box.	•	•	•	1 kit per system	1 kit per system
	<b>BRP2A81</b> Cool/heat selector PCB (required to connect KRC19-26A to VRV IV outdoor)		•	•	1 kit per system	1 kit per system
	<b>KKSA26A560*</b> - Cool/heat selector PCB mounting plate (only required when cool/heat selector PCB and Heater tape kit are combined)			•	1 kit per system	1 kit per system
Others	<b>KJB111A</b> Installation box for remote cool/heat selector KRC19-26A	•	•	•	1 kit per system	1 kit per system
	<b>EKPCAB4</b> VRV configurator		•	•	•	•
	<b>KKSB2B61*</b> Demand PCB mounting plate. Needed to mount Demand PCB for one or more outdoor units.			•		
	<b>DTA109A51</b> DIII-net expander adapter	•	•	•	•	•

## Refnets & branch selector boxes

		Refnet Joints				Refnet Headers	
		Capacity index < 200	Capacity index 200 ≤ x < 290	Capacity index 290 ≤ x < 640	Capacity index > 640	Capacity index < 290	Capacity index 290 ≤ x < 640
Refnets	Metric-size connections for heat pump systems (2-pipe)	KHRQM22M20T	KHRQM22M29T	KHRQM22M64T	KHRQM22M75T	KHRQM22M29H	KHRQM22M64H
	Imperial-size connections for heat recovery pump (2-pipe)	KHRQ22M20T	KHRQ22M29T9	KHRQ22M64T	KHRQ22M75T	KHRQ22M29H	KHRQ22M64H
	Metric-size connections for heat recovery systems (3-pipe)	KHRQM23M20T	KHRQM23M29T	KHRQM23M64T	KHRQM23M75T	KHRQM23M29H	KHRQM23M64H
	Imperial-size connections for heat recovery systems (3-pipe)	KHRQ23M20T	KHRQ23M29T9	KHRQ23M64T	KHRQ23M75T	KHRQ23M29H	KHRQ23M64H
Options for Branch selector boxes (BS box) (only for connection with VRV heat recovery system)	<b>EKBSVLNP</b> Sound reduction kit (sound insulation)						
	<b>KHFP26A100C</b> Closed pipe kit						
	<b>KHRP26A1250C</b> Joint kit						
	<b>Quiet kit</b>						

(1) For installations with special requirements towards fire regulations, the insulation material can be replaced using kits EKHBFBQ1 and EKHBFBQ2. The kits contain insulation material that complies with EN13501-1:B-S3,dO and BS476-7 (class 1)

VRV III-Q Heat Recovery Replacement VRV				VRV-W IV Water-cooled VRV				
RQEQ 140~212	2-module systems	3-module systems	4-module systems	RWEYQ8-14	Heat Pump application		Heat Recovery application	
	BHFP26P36C	BHFP26P63C	BHFP26P84C		2-module systems	3-module systems	2-module systems	3-module systems
					BHFQ22P1007 / BHFQ22P1517 (1)	BHFQ22P1517 (1)	BHFQ23P907 / BHFQ23P1357 (1)	BHFQ23P1357 (1)
•	1 kit per system	1 kit per system	1 kit per system					

DTA104A53/61/62

Installation in the RWEYQ outdoor unit possible. For installation in indoor units, use appropriate type (DTA104A53/61/62) for particular indoor unit. See Options & Accessories of indoor units

				• (for H/P only)	1 kit per system	1 kit per system		
				• (for H/P only)	1 kit per system	1 kit per system		
				• (for H/P only)	1 kit per system	1 kit per system		
•	•	•	•	•	•	•	•	•
•	•	•	•	•	•	•	•	•

Capacity index > 640	Heat Recovery Branch Selector Boxes (BS-Boxes)						
	1-port BS1Q-A	4-port BS4Q14AV1B	6-port BS6Q14AV1B	8-port BS8Q14AV1B	10-port BS10Q14AV1B	12-port BS12Q14AV1B	16-port BS16Q14AV1B
KHRQM22M75H							
KHRQ22M75H							
KHRQM23M75H							
KHRQ23M75H							
	•						
		•	•	•	•	•	•
		•	•	•	•	•	•
		KDDN26A4	KDDN26A8	KDDN26A8	KDDN26A12	KDDN26A12	KDDN26A16

		Ceiling mounted cassette units				
		Round flow (800x800)	4-way (600x600)	2-way blow		
		FXFQ 20~125B	FXZQ 15~50A	FXCQ 20~40A	FXCQ 50~63A	FXCQ 80 ~125A
Panels	Decoration panel (obligatory for cassette units, optional for others, rear panel for FXLQ)	Standard panels: BYCQ140E (white) / BYCQ140EW (full white)(1) / BYCQ140EB (black) Auto cleaning (5)(6): BYCQ140EGF (white) / BYCQ140EGFB (black) Designer panels: BYCQ140EP (white) / BYCQ140EPB (black)	BYFQ60CW (white panel) BYFQ60CS (grey panel) BYFQ60B3 (Standard panel)	BYBCQ40H	BYBCQ63H	BYBCQ125H
	Panel spacer for reducing required installation height		KDBQ44B60 (Standard panel)			
	Sealing kit for 3- or 2-directional air discharge	KDBHQ56B140 (7)	BDBHQ44C60 (white & grey panel)			
	Sensor kit	BRYQ140B (white panels) BRYQ140BB (black panels) BRYQ140C (white designer panel) BRYQ140CB (black designer panel)	BRYQ60AW (white panel) BRYQ60A5 (grey panel)			
Individual control systems	Infrared remote control including receiver	BRC7FA532F (white panels) BRC7FA532FB (black panels) BRC7FB532F (white designer panel) BRC7FB532FB (black designer panel)	BRC7F530W (9) (10) (white panel) BRC7F530S (9) (10) (grey panel) BRC7EB530 (9) (10) (standard panel)	BRC7C52	BRC7C52	BRC7C52
	<b>Madoka</b> BRC1H519W(7) (White) / BRC1H519S(7) (Silver) / BRC1H519K(7) (Black) User-friendly wired remote controller with premium design	•	•	•	•	•
	<b>BRC1E53A/B/C</b> Wired remote control with full-text interface and back-light	•	•	•	•	•
	<b>BRC1D52 (4)</b> Standard wired remote control with weekly timer	• (15)	•	•	•	•
Centralised control systems	<b>DCC601A51</b> Intelligent Tablet Controller	•	•	•	•	•
	<b>DCS601C51 (12)</b> intelligent Touch Controller	•	•	•	•	•
	<b>DCS302C51 (12)</b> Central remote control	•	•	•	•	•
	<b>DCS301B51 (12) (13)</b> Unified ON/OFF control	•	•	•	•	•
	<b>DST301B51 (12)</b> Schedule timer	•	•	•	•	•
	<b>DCM601A51</b> Intelligent Touch Manager	•	•	•	•	•
Building management system + standard protocol interface	<b>EKMBDXA</b> DIII-net modbus interface	•	•	•	•	•
	<b>KLIC-DI</b> KNX interface	•	•	•	•	•
	<b>DMS502A51</b> BACnet interface	•	•	•	•	•
	<b>DMS504B51</b> LowWorks interface	•	•	•	•	•
Filters	Replacement long life filter, non-woven type	KAFP551K160	KAFQ441BA60	KAFP531B50	KAFP531B80	KAFP531B160
	Auto cleaning filter	see decoration panel				
Adapters	Wiring adapter for external monitoring/control via dry contacts and setpoint control via 0-140Ω	KRP4A53 (2)(7)	KRP4A53 (2)	KRP4A51	KRP4A51	KRP4A51
	Wiring adapter with 2 output signals (Compressor / Error, Fan output)	KRP1BA58 (2)(7)	KRP1B57			
	Wiring adapter with 4 output signals (Compressor / Error, Fan, Aux. heater, Humidifier output)	EKRP1C12 (2)(7)	EKRP1B2	EKRP1B2	EKRP1B2	EKRP1B2
	Adapter for wiring (interlock for fresh air intake fan)					
	Wiring adapter for external central monitoring/control (controls 1 entire system)		KRP2A52	KRP2A51	KRP2A51	KRP2A51
	External control adapter for outdoor unit (installation on indoor unit)			DTA104A61	DTA104A61	DTA104A61
	Adapter for multi-tenant applications (24VAC PCB power supply interface)	DTA114A61	DTA114A61			
	Digital input adapter (2)/11	BRP7A53	BRP7A53	BRP7A51	BRP7A51	BRP7A51
	Installation box / Mounting plate for adapter PCBs (For units where there is no space in the switchbox)	KRP1H98 (7)	KRP1A101	KRP1C96	KRP1C96	KRP1C96
	External wired temperature sensor	KRCS01-7B	KRCS01-4	KRCS01-4	KRCS01-4	KRCS01-4
	<b>K.RSS</b> External wireless temperature sensor	•	•	•	•	•
Connector for forced-off contact	Standard	Standard	Standard	Standard	Standard	
Others	Multi zoning kit					
	Drain pump kit	Standard	Standard	Standard	Standard	Standard
	Fresh air intake kit	KDDP55C160-1 + KDDP55D160-2 (7)(8)	KDDQ44XA60			
	Air discharge adapter for round duct					
	Filter chamber for bottom suction			KDDFP53B50	KDDFP53B80	KDDFP53B160

(1) pump station is necessary for this option  
 (2) Installation box is necessary for these adapters  
 (3) The BYCQ140EW has white insulation. Be informed that formation of dirt on white insulation is visibly stronger and that it is consequently not advised to install the BYCQ140EW decoration panel in environments exposed to concentrations of dirt\*  
 (4) Not recommended because of the limitation of the functions  
 (5) To be able to control the BYCQ140DG(F)(B) the controller BRCIE or BRCIH\* is needed  
 (6) The BYCQ140DG(F)(B) is not compatible with Multi and Split Non-Inverter Outdoor units  
 (7) Option not available in combination with BYCQ140DG(F)(B)  
 (8) Both parts of the fresh air intake are needed for each unit

(9) Sensing function not available  
 (10) Independently controllable flaps function not available  
 (11) Only possible in combination with BRCIH\* / BRCIE\*  
 (12) When fixing box is required, use KJB212A, KJB311A or KJB411A depending on the size of the controller  
 (13) Option KEK26-1A (Noise filter) is required when installing DCS301B51  
 (14) Wire harness KEWTS is necessary  
 (15) The active airflow circulation function is not available for this controller.  
 (16) Up to 2 adaptor PCBs can be installed per installation box  
 (17) Only one installation box can be installed per indoor unit

Corner (1-way blow)		Concealed ceiling units (duct units)					
		Slim	Standard				
FXKQ 25~40MA	FXKQ 63MA	FXDQ 15~63A	FXSQ 15~32A	FXSQ 40~50A	FXSQ 63~80A	FXSQ 100~125A	FXSQ 140A
BYK45F	BYK71F						
BRC4C61	BRC4C61	BRC4C65	BRC4C65	BRC4C65	BRC4C65	BRC4C65	BRC4C65
•	•	•	•	•	•	•	•
•	•	•	•	•	•	•	•
•	•	•	•	•	•	•	•
•	•	•	•	•	•	•	•
•	•	•	•	•	•	•	•
•	•	•	•	•	•	•	•
•	•	•	•	•	•	•	•
•	•	•	•	•	•	•	•
•	•	•	•	•	•	•	•
•	•	•	•	•	•	•	•
•	•	•	•	•	•	•	•
•	•	•	•	•	•	•	•
•	•	•	•	•	•	•	•
		15-32: BAE20A62 40-50: BAE20A82 63: BAE20A102					
KRP4A51	KRP4A51	KRP4A54	KRP4A52(2)	KRP4A52(2)	KRP4A52(2)	KRP4A52(2)	KRP4A52(2)
KRP1B61	KRP1B61	KRP1B56	EKRP1B2(2)	EKRP1B2(2)	EKRP1B2(2)	EKRP1B2(2)	EKRP1B2(2)
KRP2A51	KRP2A51	KRP2A53	KRP2A51(2)	KRP2A51(2)	KRP2A51(2)	KRP2A51(2)	KRP2A51(2)
DTA104A61	DTA104A61	DTA104A53	DTA104A61	DTA104A61	DTA104A61	DTA104A61	DTA104A61
		DTA114A61	DTA114A61	DTA114A61	DTA114A61	DTA114A61	DTA114A61
BRP7A51	BRP7A51	BRP7A54	BRP7A51	BRP7A51	BRP7A51	BRP7A51	BRP7A51
		KRP1B101	KRP1BA101/ KRP1B100	KRP1BA101/ KRP1B100	KRP1BA101/ KRP1B100	KRP1BA101/ KRP1B100	KRP1BA101/ KRP1B100
KRCS01-1	KRCS01-1	KRCS01-4	KRCS01-4	KRCS01-4	KRCS01-4	KRCS01-4	KRCS01-4
•	•	•	•	•	•	•	•
Standard	Standard		Standard	Standard	Standard	Standard	Standard
Standard	Standard	Standard	Standard	Standard	Standard	Standard	Standard
			KDAP25A36A	KDAP25A56A	KDAP25A71A	KDAP25A140A	

		Concealed ceiling units (duct units)			Ceiling suspended units		
		High efficiency		Large	1-way blow		
		FXMQ 50~80	FXMQ 100~125	FXMQ 200~250	FXHQ 32A	FXHQ 63A	FXHQ 71~100A
Panels	Decoration panel (obligatory for cassette units, optional for others, rear panel for FXLQ)						
	Panel spacer for reducing required installation height						
	Sealing kit for 3- or 2-directional air discharge						
	Sensor kit						
Individual control systems	Infrared remote control including receiver	BRC4C65	BRC4C65	BRC4C65	BRC7G53	BRC7G53	BRC7G53
	<b>Madoka</b> BRC1H519W(7) (White) / BRC1H519S(7) (Silver) / BRC1H519K(7) (Black) User-friendly wired remote controller with premium design	•	•	•	•	•	•
	<b>BRCIE53A/B/C</b> Wired remote control with full-text interface and back-light	•	•	•	•	•	•
	<b>BRC1D52 (4)</b> Standard wired remote control with weekly timer	•	•	•	•	•	•
Centralised control systems	<b>DCC601A51</b> Intelligent Tablet Controller	•	•	•	•	•	•
	<b>DCS601C51 (12)</b> intelligent Touch Controller	•	•	•	•	•	•
	<b>DCS302C51 (12)</b> Central remote control	•	•	•	•	•	•
	<b>DCS301B51 (12) (13)</b> Unified ON/OFF control	•	•	•	•	•	•
	<b>DST301B51 (12)</b> Schedule timer	•	•	•	•	•	•
Building management system + standard protocol interface	<b>DCM601A51</b> Intelligent Touch Manager	•	•	•	•	•	•
	<b>EKMBDXA</b> DIII-net modbus interface	•	•	•	•	•	•
	<b>KLIC-DI</b> KNX interface	•	•	•	•	•	•
	<b>DMS502A51</b> BACnet interface	•	•	•	•	•	•
	<b>DMS504B51</b> LowWorks interface	•	•	•	•	•	•
Filters	Replacement long life filter, non-woven type				KAFP501A56	KAFP501A80	KAFP501A160
	Auto cleaning filter						
Adapters	Wiring adapter for external monitoring/control via dry contacts and setpoint control via 0-140Ω	KRP4A51	KRP4A51	KRP4A51	KRP4A52	KRP4A52	KRP4A52
	Wiring adapter with 2 output signals (Compressor / Error, Fan output)				KRP1B54	KRP1B54	KRP1B54
	Wiring adapter with 4 output signals (Compressor / Error, Fan, Aux. heater, Humidifier output)	EKRP1B2	EKRP1B2	KRP1B61			
	Adapter for wiring (interlock for fresh air intake fan)						
	Wiring adapter for external central monitoring/control (controls 1 entire system)	KRP2A51	KRP2A51	KRP2A51	KRP2A62	KRP2A62	KRP2A62
	External control adapter for outdoor unit (installation on indoor unit)	DTA104A61	DTA104A61	DTA104A61	DTA104A62	DTA104A62	DTA104A62
	Adapter for multi-tenant applications (24VAC PCB power supply interface)	DTA114A61	DTA114A61				
	Digital input adapter (2) / (11)	BRP7A51	BRP7A51	BRP7A51	BRP7A52	BRP7A52	BRP7A52
	Installation box / Mounting plate for adapter PCBs (For units where there is no space in the switchbox)	KRP4A96	KRP4A96		KRP1D93A	KRP1D93A	KRP1D93A
	External wired temperature sensor	KRCS01-4	KRCS01-4	KRCS01-1	KRCS01-4	KRCS01-4	KRCS01-4
<b>K.R55</b> External wireless temperature sensor	•	•	•	•	•	•	
Connector for forced-off contact	Standard	Standard	Standard	EKRORO4	EKRORO4	EKRORO4	
Others	Multi zoning kit						
	Drain pump kit	Standard	Standard		KDU50P60	KDU50P140	KDU50P140
	Fresh air intake kit				KDDQ50A140	KDDQ50A140	KDDQ50A140
	Air discharge adapter for round duct	KDAJ25K71	KDAJ25K140				
L-type piping kit (for upward direction)				KHFP5M35	KHFP5N63	KHFP5N160	

- (1) pump station is necessary for this option
- (2) Installation box is necessary for these adapters
- (3) The BYCQ140EW has white insulation. Be informed that formation of dirt on white insulation is visibly stronger and that it is consequently not advised to install the BYCQ140E decoration panel in environments exposed to concentrations of dirt\*
- (4) Not recommended because of the limitation of the functions
- (5) To be able to control the BYCQ140DG(F)(B) the controller BRCIE is needed
- (6) The BYCQ140DG(F)(B) is not compatible with Multi and Split Non-Inverter Outdoor units
- (7) Option not available in combination with BYCQ140DG(F)(B)
- (8) Both parts of the fresh air intake are needed for each unit
- (9) Sensing function not available
- (10) Independently controllable flaps function not available
- (11) Only possible in combination with BRC1H\* / BRCIE\*
- (12) When fixing box is required, use KJB212A, KJB311A or KJB411A depending on the size of the controller
- (13) Option KEK26-1A (Noise filter) is required when installing DCS301B51
- (14) Wire harness EKEWTSC is necessary
- (15) The active airflow circulation function is not available for this controller.
- (16) Up to 2 adaptor PCBs can be installed per installation box
- (17) Only one installation box can be installed per indoor unit

4-way blow FXUQ 71~100A	Wall mounted units	Floor standing units			
	FXAQ 15~63	Concealed	Free-standing		
		FXNQ 20~63	FXLQ 20~25	FXLQ 32~40	FXLQ 50~63
			EKRDP25A	EKRDP40A	EKRDP63A
KDBHP49B140 + KDBTP49B140					
BRC7C58	BRC7EA628	BRC4C65	BRC4C65	BRC4C65	BRC4C65
•	•	•	•	•	•
•	•	•	•	•	•
•	•	•	•	•	•
•	•	•	•	•	•
•	•	•	•	•	•
•	•	•	•	•	•
•	•	•	•	•	•
•	•	•	•	•	•
•	•	•	•	•	•
•	•	•	•	•	•
•	•	•	•	•	•
•	•	•	•	•	•
•	•	•	•	•	•
•	•	•	•	•	•
•	•	•	•	•	•
KAFP551K160					
KRP4A53 *2	KRP4AA51(2)	KRP4A54	KRP4A51	KRP4A51	KRP4A51
	KRP1B56	KRP1B56	KRP1B61	KRP1B61	KRP1B61
	KRP2A51 / KRP2A61(2)	KRP2A53	KRP2A51	KRP2A51	KRP2A51
	DTA104A51 / DTA104A61				
	DTA114A61	DTA114A61	EKMTAC	EKMTAC	EKMTAC
BRP7A53		BRP7A51	BRP7A51	BRP7A51	BRP7A51
KRP1B97	KRP4AA93(15)(16)				
KRCS01-4	KRCS01-1B	KRCS01-4	KRCS01-1	KRCS01-1	KRCS01-1
•	• (14)	•	•	•	•
EKROR05	Standard	Standard	Standard	Standard	Standard
	K-KDU572EVE				

	HXY080-125A8	HXHD125-200A8
Drain pan	EKHBDFCA2	-
Digital I/O PCB	EKRPIHBAA	-
Demand PCB - Required to connect room thermostat	EKRPIAHTA	-
Remote user interface (remocon) - Same controller as supplied with cascade unit can be mounted parallel or on other location. If 2 controllers are installed, the installer needs to select 1 master & 1 slave	EKRUAHTB	-
Back-up heater	EKBUHAA6(W1/V3)	-
Wired room thermostat - Requires demand PCB EKRPIAHTA	EKRRTWA	-
Wireless room thermostat - Requires demand PCB EKRPIAHTA	EKRTR1	-
Remote sensor for room thermostat - Requires demand PCB EKRPIAHTA	EKRTEETS	-
Domestic hot water tank - standard (stacked on top of hydrobox)	-	EKHTS200AC EKHTS260AC
Domestic hot water tank - with possibility for solar connection	-	EKHWP500B
Solar collector *1	-	EKS26P (vertical) EKSH26P (horizontal)
Pump station	-	EKSRRS

		Heat Recovery Ventilation - Modular L (Smart)				Energy reclaim ventilation - VAM										Energy reclaim ventilation VKM			Air handling unit applications		
		ALB 02LBS/ RBS	ALB 03LBS/ RBS	ALB 04,05LBS/ RBS	ALB 06,07LBS/ RBS	VAM 150FC	VAM 250FC	VAM 350J	VAM 500J	VAM 650J	VAM 800J	VAM 1000J	VAM 1500J	VAM 2000J	VKM 50GB (M)	VKM 80GB (M)	VKM 100GB (M)	EKEQ FCBA (1)	EKEQ DCB (1)	EKEQ MCBA (1)	
Individual control systems	BRC301B61 VAM wired remote control	•	•	•	•	•	•	•	•	•	•	•	•	•							
	Madoka BRC1H519W(7) (Glossy white) / BRC1H519S(7) (Silver Metallic) / BRC1H519K(7) (Black matte) User-friendly wired remote controller with premium design	•	•	•	•	•	•	•	•	•	•	•	•	•	•	•	•	•	•	•	
	BRC1E53A/B/C Wired remote control with full-text interface and back-light	•	•	•	•	•	•	•	•	•	•	•	•	•	•	•	•	•	•	•	
	BRC1D52 Standard wired remote control with weekly timer	•	•	•	•	•	•	•	•	•	•	•	•	•	•	•	•	•	•	•	
Centralised control systems	DCC601A51 intelligent Tablet Controller	•	•	•	•	•	•	•	•	•	•	•	•	•	•	•	•	•	•	•	
	DCM601A51 intelligent Touch Controller	•	•	•	•	•	•	•	•	•	•	•	•	•	•	•	•	•	•	•	
	DCS302C51 Central remote control	•	•	•	•	•	•	•	•	•	•	•	•	•	•	•	•	•	•	•	
	DCS301B51 Unified ON/OFF control	•	•	•	•	•	•	•	•	•	•	•	•	•	•	•	•	•	•	•	
	DST301B51 Schedule timer	•	•	•	•	•	•	•	•	•	•	•	•	•	•	•	•	•	•	•	
	Building Management System & Standard protocol Interface	DCM601A51 intelligent Touch Manager	•	•	•	•	•	•	•	•	•	•	•	•	•	•	•	•	•	•	•
EKMBDXA Modbus interface		•	•	•	•	•	•	•	•	•	•	•	•	•	•	•	•	•	•	•	
DMS502A51 BACnet Interface		•	•	•	•	•	•	•	•	•	•	•	•	•	•	•	•	•	•	•	
DMS504B51 LonWorks Interface		•	•	•	•	•	•	•	•	•	•	•	•	•	•	•	•	•	•	•	
Filters		Coarse 55% (G4)	ALF 02G4A	ALF 03G4A	ALF 05G4A	ALF 07G4A															
	ePM <sub>10</sub> 75% (M5)	ALF 02M5A	ALF 03M5A	ALF 05M5A	ALF 07M5A																
	ePM <sub>10</sub> 70% (M6)						EKAFVJ 50F6	EKAFVJ 50F6	EKAFVJ 65F6	EKAFVJ 100F6	EKAFVJ 100F6	EKAFVJ 100F6 x2	EKAFVJ 100F6 x2								
	ePM <sub>1</sub> 50% (F7)	ALF 02F7A	ALF 03F7A	ALF 05F7A	ALF 07F7A																
	ePM <sub>1</sub> 55% (F7)						EKAFVJ 50F7	EKAFVJ 50F7	EKAFVJ 65F7	EKAFVJ 100F7	EKAFVJ 100F7	EKAFVJ 100F7 x2	EKAFVJ 100F7 x2								
	ePM <sub>1</sub> 70% (F8)						EKAFVJ 50F8	EKAFVJ 50F8	EKAFVJ 65F8	EKAFVJ 100F8	EKAFVJ 100F8	EKAFVJ 100F8 x2	EKAFVJ 100F8 x2								
	ePM <sub>1</sub> 80% (F9)	ALF 02F9A	ALF 03F9A	ALF 05F9A	ALF 07F9A																
	High efficiency filter														KAF 242H80M	KAF 242H100M	KAF 242H100M				
	Replacement air filter														KAF 241H80M	KAF 241H100M	KAF 241H100M				
	Mechanical accessories	Rail	ALA 02RLA	ALA 03RLA	ALA 05RLA	ALA 07RLA															
Rectangular to round duct transition		ALA 02RCA	ALA 03RC	ALA 05RCA	ALA 07RCA																
Separate plenum													EKPLEN 200 (6)	EKPLEN 200 (6)							
CO <sub>2</sub> sensor	BRYMA200 (preliminary)	BRYMA200 (preliminary)	BRYMA200 (preliminary)	BRYMA200 (preliminary)			BRYMA 65	BRYMA 65	BRYMA 65	BRYMA 100	BRYMA 100	BRYMA 200	BRYMA 200	BRYMA 65	BRYMA 100	BRYMA 200					
Electrical heater	ALD 02HEFB	ALD 03HEFB	ALD 05HEFB	ALD 07HEFB	VH1B	VH2B	VH3B	VH3B	VH4B / VH4/AB	VH4B / VH4/AB	VH4B / VH4/AB	VH5B(7)	VH5B(7)								
Silencer (900mm depth)	ALS 0290A	ALS 0390A	ALS 0590A	ALS 0790A																	
Electrical accessories	Wiring adapter for external monitoring/control (controls 1 entire system)					KRP2A51	KRP2A51	KRP2A51 (2)	KRP2A51 (2)	KRP2A51 (2)	KRP2A51 (2)	KRP2A51 (2)	KRP2A51 (2)	KRP2A51 (2)	BRP 4A50A (4)	BRP 4A50A (4)	BRP 4A50A (4)				
	Adapter PCB for humidifier					KRP50-2	KRP50-2	KRP1C4 (5)	KRP1C4 (5)	KRP1C4 (3/5)	KRP1C4 (5)	KRP1C4 (5)	KRP1C4 (3/5)	KRP1C4 (3/5)	BRP 4A50A (4)	BRP 4A50A (4)	BRP 4A50A (4)				
	Adapter PCB for third party heater					BRP4A50	BRP4A50	BRP 4A50A (4)	BRP 4A50A (4)	BRP 4A50A (3/4)	BRP 4A50A (4)	BRP 4A50A (4)	BRP 4A50A (3/4)	BRP 4A50A (3/4)	BRP 4A50A (4)	BRP 4A50A (4)	BRP 4A50A (4)				
	External wired temperature sensor																				KRCS01-1
	Adapter PCB Mounting plate										EKMP 65VAM			EKMPVAM							

- Notes
- (1) Do not connect the system to DIII-net devices LONWorks interface, BACnet interface, ...; (intelligent Touch Manager, EKMBDXA are allowed)
  - (2) Installation box KRP1BA101 needed
  - (3) Adapter PCB mounting plate needed, applicable model can be found in the table above
  - (4) 3rd party heater and 3rd party humidifier cannot be combined
  - (5) Installation box KRP50-2A90 needed
  - (6) Contains 1 plenum and can be used for half side of the unit (up to 4 plenums can be used on 1 unit)
  - (7) Available only with optional plenum



## Individual and centralised controls

	BRCID*	BRCIE*	BRCIH*	DCS301B51	DST301B51	DCS302C51	DCS601C51
Madoka Assistant app for advanced settings			•				
Electical box KJB111A	•	•	•				
Electical box KJB212A(A) (1)	•	•		•	•		
Electical box KJB311A(A)						•	
Electical box KJB411AA							•

(1) recommended as wider (more stable mounting)

## Intelligent Tablet Controller - DCC601A51

		Intelligent Controller		
		Options for local control	Cloud options	Software
Wired screen for local control	AL-CCD07-VESA-1	•	-	-
Zenpad 8" Tablet for local control	Z380M	•	-	-
Control and monitoring package		-	•	-
Remote support and diagnostics package		-	•	-
Advise and optimisation package		-	•	-
App for tablet - download for Android (Play store) only (In case of AL-CCD07-VESA-1 app is pre-installed)		-	-	•
Commissioning tool		-	-	•
Software update tool		-	-	•

Daikin Cloud Service requires a subscription. Contact your local sales representative for more information

## Intelligent Touch Manager - DCM601A51

		Intelligent Manager	Cloud options
iTM plus adapter – Allows connection of an additional 64 indoor units/groups. Up to 7 adapters can be connected	DCM601A52	•	
iTM PPD software – Allows distribution of used kWh by indoor units connected to the iTM	DCM002A51	•	
iTM HTTP interface - Allows communication to any third party controller via http interface	DCM007A51	•	
iTM Energy navigator – Energy management option	DCM008A51	•	
iTM BACnet Client option – Enables integration of third party devices to the iTM via the BACnet/IP protocol. (This is not a gateway and cannot replace DMS502A51)	DCM009A51	•	
Property Management System (PMS) interface option - Enables to connect to third party PMS systems	DCM010A51	• Oracle Opera PMS	
Control and monitoring package			•
Remote support and diagnostics package			•
Advise and optimisation package			•

## Standard protocol interfaces - DMS502A51

		BACnet Interface
DIII-net expansion board (2 ports), connects up to 128 additional indoor units	DAM411B51	•
Digital pulse inputs (12) for PPD functionality	DAM412B51	•

# We're here to help you!

## Online and offline

### Online and offline VRV selection software



Business portal via mobile or desktop

[my.daikin.eu](http://my.daikin.eu)

Full BIM object library available

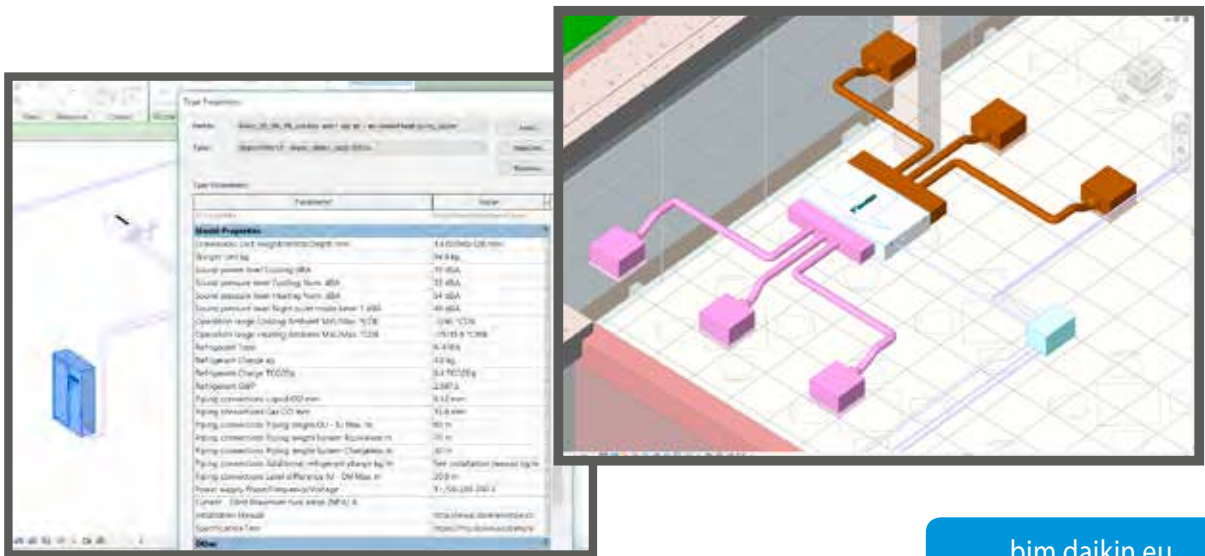

[bim.daikin.eu](http://bim.daikin.eu)

# Tools and platforms

Literature overview	204
Supporting tools, software and apps	206
30 years of history	210

Reference books:

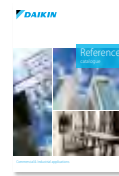

**Reference catalogue**  
Daikin commercial and industrial references

213

Product profiles:



**VRV IV S-series**  
Main benefits, application examples and specs of VRV IV S-series product range

208



**VRV IV i-series**  
Main benefits, application examples and specs of VRV IV i-series product range

207

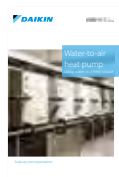

**Water-to-air heat pump**  
Detailed info on VRV IVW-series, application examples, technical system design background

209

Focus topics:



**Replacement Technology**  
Clear installer benefits of VRV replacement technology

214



**Infrastructure cooling**  
Clear installer benefits why to choose Daikin for infrastructure cooling

140

Product flyers:

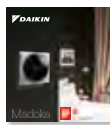

**Madoka**  
Detailed info on BRC1H\* remote control

306

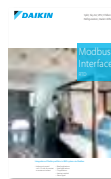

**RTD modbus interface**  
Detailed info on RTD controls and applications

308

Product catalogues:



**Sky Air Catalogue**  
Detailed technical information & benefits on Sky Air

100

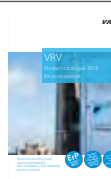

**VRV Catalogue**  
Detailed technical information & benefits of the VRV total solution

200



**Ventilation Catalogue**  
Detailed info on Ventilation products

203



**Commercial Solutions**  
Daikin offers solutions for commercial applications

100

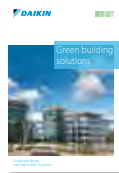

**Green Building Solutions**  
Clear building owner/investor benefits why to choose Daikin for a green building, with emphasis on BREEAM

216



**Hotel Solutions**  
Clear building owner/investor benefits why to choose Daikin for a hotel

218

Reference books:

Product profiles:



**Intelligent Touch Manager**  
Detailed benefits of Intelligent Touch Manager

302



**Intelligent Tablet Controller**  
Detailed benefits of Intelligent Tablet Controller

303



**Daikin Cloud Service**  
Details on the Daikin Cloud connection

542

Focus topics:



**Replacement technology**  
Clear building owner/investor benefits of replacement technology

15-215



**F-gas regulation**  
Details on the F-gas regulation and how Daikin is prepared for the future HVAC-R market

605

Product flyers:

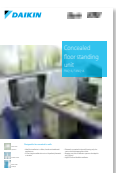

**Sky Air product leaflets**  
Single page leaflet with the main benefits and technical specifications of each individual Sky Air unit. Ideal for quotations



**VRV product leaflets**  
Single page leaflet with the main benefits and technical specifications of each individual VRV unit. Ideal for quotations



**Technical documentation:**

Download all technical documentation such as engineering data-books, selection software, installation and operation manuals and service manuals directly from our business portal: [my.daikin.eu](http://my.daikin.eu)

# Supporting tools, software and apps

[www.daikineurope.com/  
support-and-manuals/  
software-downloads](http://www.daikineurope.com/support-and-manuals/software-downloads)

## New web based Xpress selection software

### Making selection easy, anytime, anywhere

- › Web & cloudbased, access to your projects from anywhere, anyplace...
- › Platform (Windows, Mac, ...) and hardware (laptop, desktop, tablet) independent
- › Re-engineered GUI for maximum easy of use
- › No need to do local installation
- › No tool updates required (always latest version available)
- › Possibility to copy / share projects

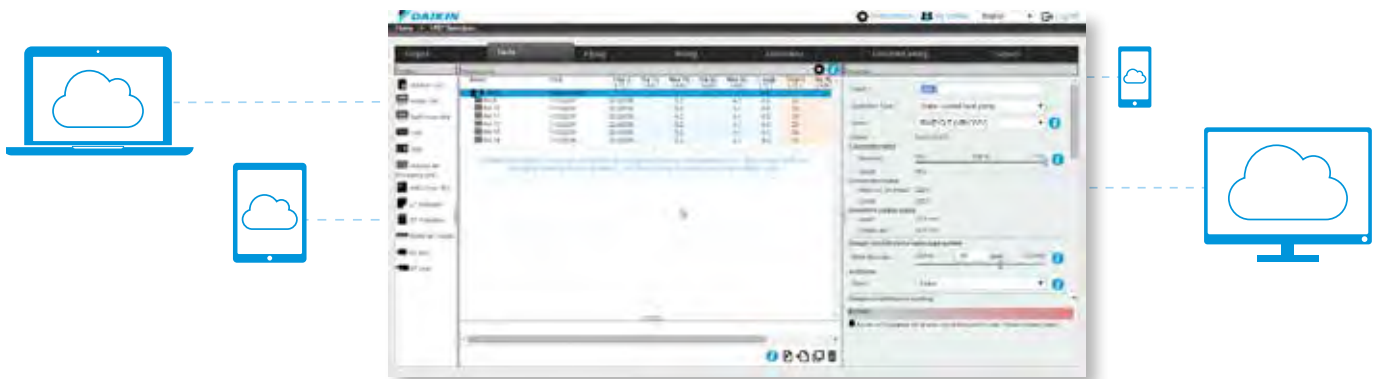

Easy selection, anytime, anywhere

### Main functions



Easy editing of piping

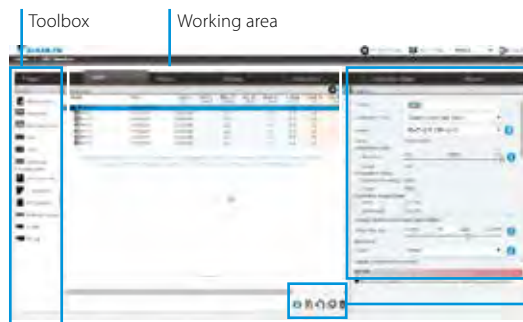

Intuitive interface

Detailed properties

Import / Export / Delete indoors



Clear wiring overview, easy to make control groups



Clear overview of control groups and central controls

## Other selection software

### VRV Pro

Enables VRV air conditioning systems to be engineered in a precise and economical way, taking into account the complex piping rules. Moreover, it ensures optimum operating cycles and maximum energy efficiency.

- › Accurate heat load calculation
- › Precise selection based on peak loads
- › Energy consumption indication

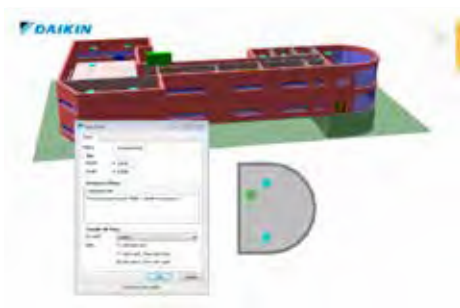

### Ventilation Xpress

Selection tool for ventilation devices (VAM, VKM). The selection is based on given supply/extract airflows (including fresh up and given ESP of supply/extract ducting):

- › Determines size of electrical heaters
- › Visualisation of psychrometric chart
- › Visualisation of selected configuration
- › Required field settings mentioned in the report

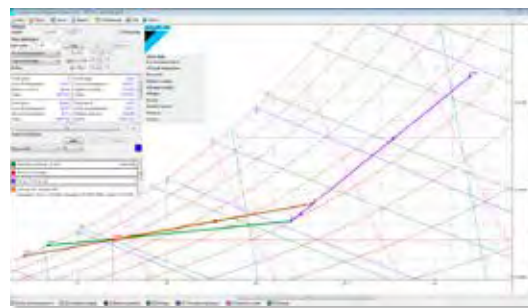

### Webbased ASTRA selection **NEW** for air handling units

A powerful tool to select the right Air Handling Units for your needs.

- › 3D interface
- › quick selection procedures
- › new print-out possibilities and report shapes



### WAGO selection tool **NEW**

The WAGO Selection Tool is specifically designed to select the optimal WAGO I/O system for your needs.

- › Easy selection of WAGO materials
- › Material list creation
- › Time saving
  - Includes wiring schemes
  - Contains commissioning/preset data for



## Plugins and third-party software tools

### Building Information Modelling (BIM) support

- › BIM improves efficiency of design and build phase
- › Daikin is among the first to supply a full library of BIM objects for its VRV products



[www.daikin.eu/bim](http://www.daikin.eu/bim)

### VRV CAD 2D

- › Displays VRV pipe design on a Autocad 2D floorplan
- › Improves project management
- › Accurately calculates the pipe dimensions and refnets
- › Determines the outdoor unit size
- › Validates VRV pipe rules
- › Accounts for the extra refrigerant charge, including a max room concentration check



<http://www.daikineurope.com/autocad/index.jsp>

## Energy simulation and design aid tools

### Seasonal simulator

- › The Seasonal Simulator is an innovative software tool that calculates and compares potential seasonal efficiency ratings.
- › This user-friendly tool compares various Daikin systems, annual power consumption, CO<sub>2</sub> emissions, and much more, to present an accurate ROI calculation in a matter of minutes.



### Psychrometrics diagram **NEW**

- › The Psychrometrics Diagram Viewer demonstrates the changing properties of moist air.
- › With this tool, users can choose two points with specific conditions, plot them on the diagram and select actions to change the conditions, i.e. heat, cool and mix air.

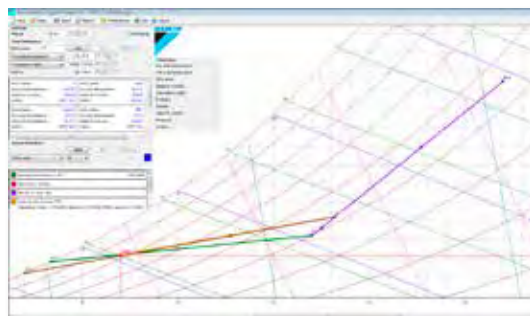



# Service tools

## Error code app

Quickly know the meaning of fault codes, for each product family and the potential cause



## D-Checker

D-checker is a software application used to record and monitor operation data of Daikin applied, split, Multi-split, Sky-air units, Daikin Altherma LT, ground source heat pump, Hybrid, ZEAS, Conveni-pack & R410A Booster unit

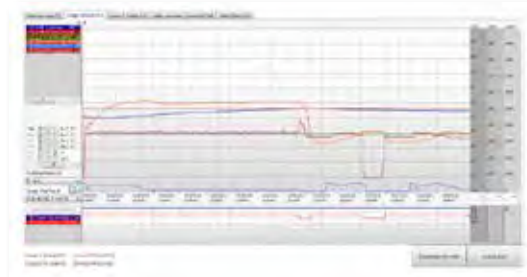

## Bluetooth adaptor **NEW**

Monitoring of Split, Sky Air and VRV data via any bluetooth device

- › No need to access the outdoor unit
  - Connects with D-Checker software (for laptops)
  - Connects with monitoring app (for tablets or smartphones)

Diagnosis of the Bluetooth system possible:



## VRV Service-Checker

- › Connected via F1/F2 bus to check multiple systems at the same time
- › Connection of external pressure sensors possible

# Online support

## **NEW** Business portal

- › Experience our new extranet that thinks with you at [my.daikin.eu](http://my.daikin.eu)
- › Find information in seconds via a powerful search
- › Customise the options so you see only info relevant for you
- › Access via mobile device or desktop

[my.daikin.eu](http://my.daikin.eu)



# Internet

Find our solution for different applications:

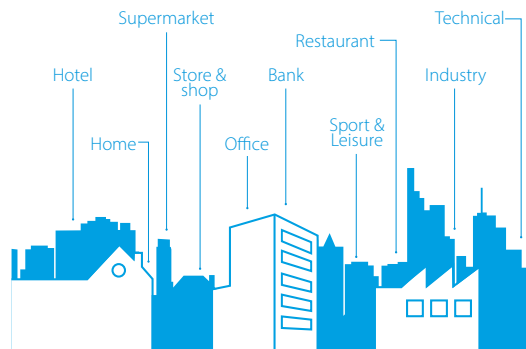

- › Get more commercial details on our flagship products via our dedicated minisites
- › See our references



[www.daikineurope.com/references](http://www.daikineurope.com/references)

# Over 30 years of VRV History



**R-22**

1987

**Introduction the original VRV air conditioning system to Europe, invented by Daikin in 1982**

- > Up to 6 indoor units connected to 1 outdoor unit



**R-407C**

1998

**Launch inverter series with R-407C**

- > Up to 16 indoor units connected to 1 outdoor unit



2004

**Expand to light commercial sector with VRVII-S**

- > Available in 4, 5, 6HP capacities
- > 1 system can be installed in up to 9 rooms



2008

**Launch of heat pump optimised for heating (VRV III-C)**

- > Extended operation down to -25C
- > 2-stage compressor systems

1987

1991

1998

2003

2004

2005

2006-2007

2008

1991

**Introduce VRV heat recovery**

- > Simultaneous cooling and heating



2003

**Introduce VRVII-- the first R-410A VRF system**

Available in cooling, heat pump and heat recovery

- > 40 units connected to single refrigerant circuit

**R-410A**



2005

**Extends VRVII inverter range with water cooled VRV-WIII**

- > Available in heat pump and heat recovery



2006-2007

**Launch the extensively re-engineered VRVIII**

- > Available in cooling, heat pump and heat recovery
- > Automatic charging and testing
- > Up to 64 units connected to 1 system





2009

**Extends VRVIII range with water cooled VRV-WIII**

- > Geothermal version available
- > Operate down to -10C in heating mode



2011

**Launch total solution concept**

- > Integrate hot water production and Biddle air curtains into VRV system
- > Connectable to Daikin Emura and Nexura
- > 400,000 outdoors units sold
- > 2.2 million indoor units sold



2015

**Launch of VRV IV S-series**

- > Most compact unit in the market
- > Widest range in the market



2018

**Launch of VRV IV C+series**

- > Optimised for heating in cold regions
- > With new unique Vapour injection compressor with back-pressure control

2009

2010

2011

2012

2015

2018

2010

**Launch of replacement VRV (VRVIII-Q)**

- > Upgrade to replace older VRV units using R-22 refrigerant



2012-2014

**Setting new standards with the launch of VRV IV**

- > 28% improved seasonal efficiency
- > Continuous heating on heat pumps
- > Available in heat pump, heat recovery, water-cooled and replacement series



2015

**Launch of VRV IV i-series**

- > The invisible VRV
- > Unique product concept







The most comfortable cassette  
just got better



## New round flow cassette

- › **Bigger flaps** and **new sensor logic** further improves equal air distribution in the room
- › **Widest ever choice in panels** for cassette units, with up to 8 different panels
- › Comes with the known benefits: **360° air flow discharge and intelligent sensors**
- › **Auto cleaning** panels available in black and white

**VRV**  
**SkyAir**

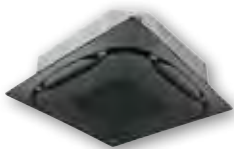

Black auto cleaning panel

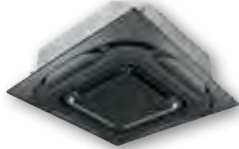

Black designer panel



Full white standard panel



White designer panel

**Daikin Europe N.V.** Naamloze Vennootschap Zandvoordestraat 300 · 8400 Oostende · Belgium · [www.daikin.eu](http://www.daikin.eu) · BE 0412 120 336 · RPR Oostende (Publisher)

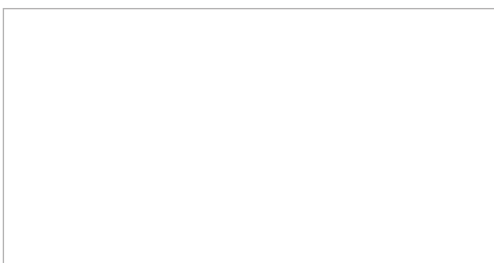

ECPEN19-200

03/19



Daikin Europe N.V. participates in the Eurovent Certified Performance programme for Liquid Chilling Packages and Hydronic Heat Pumps, Fan Coil Units and Variable Refrigerant Flow systems. Check ongoing validity of certificate: [www.eurovent-certification.com](http://www.eurovent-certification.com)



The present publication is drawn up by way of information only and does not constitute an offer binding upon Daikin Europe N.V. Daikin Europe N.V. has compiled the content of this publication to the best of its knowledge. No express or implied warranty is given for the completeness, accuracy, reliability or fitness for particular purpose of its content and the products and services presented therein. Specifications are subject to change without prior notice. Daikin Europe N.V. explicitly rejects any liability for any direct or indirect damage, in the broadest sense, arising from or related to the use and/or interpretation of this publication. All content is copyrighted by Daikin Europe N.V.

Printed on non-chlorinated paper.